

Guidelines for the Successful Implementation of Concurrent Engineering Practices in the South African Electronics Industry

Dhiren Seeruttun
B.Sc. (Eng) University of Cape Town

Thesis submitted to the Department of School of Engineering Management of the
University of Cape Town in partial fulfilment of the requirements for the degree of
Master of Science in Engineering Management.

30 September, 1995.

The copyright of this thesis vests in the author. No quotation from it or information derived from it is to be published without full acknowledgement of the source. The thesis is to be used for private study or non-commercial research purposes only.

Published by the University of Cape Town (UCT) in terms of the non-exclusive license granted to UCT by the author.

Declaration :

DECLARATION

I, the undersigned, hereby declare that this dissertation is my own unaided work. It has not been submitted for any other degree or examination at any other university.

Dhiren Seeruttun

This 30th day of September 1995.

Acknowledgments :

ACKNOWLEDGMENTS

The work represented by this thesis would not have been possible without the invaluable assistance of the following persons or companies.

Firstly, I would like to express my sincere appreciation and gratitude to my supervisor, Mr. Gordon Lister for his guidance and constant support for the duration that it took to complete this thesis.

Thanks are especially due to Mr. Allan Saul of RF Design Laboratory for financing my study, and Miss Preeta Auckel for assisting with the proof-reading of this thesis.

My special thanks go to the practitioners of concurrent engineering at Plessey Tellumat, Dr. Steve Minnaar and Mr. Bob Evans, for their valuable inputs.

Finally, I would like to thank all those who answered my survey questionnaires.

Abstract :

ABSTRACT

This thesis describes the concurrent engineering environment necessary for developing electronics products in the 1990s, and beyond. The broad scope of the research has made it possible to derive guidelines for the successful implementation of concurrent engineering in the South African electronics manufacturing industry.

For a long time, design and manufacturing have been viewed as two distinct steps that must be sequential. The problem is that this process delays product introductions and promotes design errors that have to be caught either in the field or on the factory floor. Nevertheless, these drawbacks were viewed as simply an evil of modern industry.

Today, progressive companies see that there is a better way to do things. Viewing product design and manufacturing engineering as separate entities is yesterday's technology. Both can be done at the same time in the process called Concurrent Engineering (CE).

The ever increasing competition in the industry environment is the driving force behind CE. Manufacturing companies could once operate at a leisurely pace with time-consuming iterations in both product design and manufacturing development. Today they cannot afford that luxury. With almost every manufacturer having international as well as domestic competitors, engineering is under pressure to get the job done as rapidly as possible with solutions that are optimum on the first try.

The potential advantages of concurrent engineering have been recognized for decades: Faster cycle time, better products, and a more responsive organization. But earlier calls for it were thwarted by strong hierarchical management structures and by the lack of computerized tools to spur cooperation between departments.

Now that such tools are emerging, top management is working hard to force design and manufacturing, in particular, to collaborate. Starting and sustaining CE is not easy however. It takes dedication and discipline, as well as a sweeping cultural change, and a whole new way of doing things. Embarking on a CE program without considering all its related issues, especially the soft ones, can be detrimental to a company.

Guidelines have been derived in this thesis for a successful implementation of CE.

Table of Contents :

TABLE OF CONTENTS

Contents	Page
Declaration	i
Acknowledgments	ii
Abstract	iii
List of illustrations	viii
List of Appendices	x
Glossary of Terms	xi
1. Introduction	1
1.1 Objectives of the Research Study	2
1.2 The South African Electronics Industry & its Competitiveness	3
1.3 The Need of Change in the Electronics Industry	4
1.4 The Need for Concurrent Engineering in the Electronics Industry	6
2. Literature Review	8
2.1 History of Concurrent Engineering	8
2.2 Concurrent Engineering versus "Over-the -wall" Engineering	10
2.2.1 The Product Development Process	12
2.2.2 Time-to-Market	15
2.2.3 Product Design Iterations (Changes)	17
2.3 Who should adopt Concurrent Engineering ?	20
2.4 Successful Applications CE in Overseas Companies	20
2.5 Findings from the Literature Review	26
2.5.1 Hewlett Packard (HP)	26
2.5.2 Chipcom Corporation	29
2.5.3 Sun Microsystems Inc..	34
2.5.4 Conclusions from the Literature Review	38
2.6 CE as Management's New Competitive Weapon	38

3. Research Method	41
3.1 The Scope and Limitations of the Survey	43
3.2 The Questionnaire Construction	43
3.2.1 Primary Questionnaire Construction	44
3.2.2 Secondary Questionnaire Construction	45
3.2.3 Interviews with Concurrent Engineering Practitioners	45
4. Findings of the Industrial Surveys	46
4.1 Findings of Primary Questionnaire	46
4.1.1 Level of Awareness of the CE Concept	46
4.1.2 Degree of Concurrent Engineering Application	48
4.1.3 Future Plans to Implement Concurrent Engineering & Resistance Levels	49
4.2 Findings of the Secondary Questionnaire	52
4.3 Findings from the Interviews	64
4.4 Conclusions from the Industrial Survey	70
4.5 Enabling Factors of CE at Plessey, Conlog & Tek Logic	71
5. Derived Guidelines to the Successful Implementation of a CE Program	73
5.1 The Organizational Dimension of Concurrent Engineering	74
5.1.1 The Role of Top Management	73
5.1.2 The Product Development Multi-Disciplinary CE Team(s)	76
5.1.3 Team Training and Building CE Awareness Among Employees	83
5.2 The Communication Infrastructure Dimensions of CE	84
5.2.1 Hardware Requirements for CE Environment	86
5.2.2 Software Requirements for CE Environment	87
5.2.2.1 Commercially Available CE Software Support System	91
5.2.2.2 Tailor-made CE Software Support System	92
5.3 The Customer Requirements Dimension of CE	95
5.4 The Product Development Process Dimension of CE	97
5.4.1 Planning the CE Process	97
5.4.2 Functional Roles in CE Process	99
5.5 Establishment of Pilot CE Projects	102
5.5.1 Identify Projects, Not Areas	103
5.5.2 The Type of Project to Look for	103

5.5.3	Criteria for Selecting Pilot CE Projects	104
5.5.4	Planning the Pilot CE Project	105
5.6	Maintaining the Momentum of CE Once it is Established	108
5.7	Benchmarking Your Company for CE	109
5.8	Measuring Concurrent Engineering	110
5.9	Comparative Analysis	112
6.	Conclusions and Recommendations	113
7.	Future Developments in Concurrent Engineering	116
	List of References	117
	Bibliography	122
	Appendix I	127
	Appendix II	130
	Appendix III	136
	Appendix IV	138

List of illustrations :

LIST OF ILLUSTRATIONS

FIGURE	PAGE
2-1 Diagrammatical representation of the sequential and concurrent product development processes	13
2-2 With conventional engineering, functions are sequential, but with CE, jobs are done concurrently	14
2-3 Product development slippage effects on life cycle sales	16
2-4 The sequential design process	17
2-5 The concurrent engineering environment	18
2-6 Lost profits when a product is not competitive	20
2-7 NPI Program Information Flow at Sun Microsystems	35
4-1 Proportion of managers being either aware or unaware of the CE concept	46
4-2 Degree of knowledge of the CE concept claimed by managers	47
4-3 Percentage of South African electronics companies which have and have not experimented with CE	49
5-1 How PIMs/PDMs help concurrent engineers	89
5-2 New Product Characterization	104

TABLE		PAGE
2-1	Cost of arriving late to market.	15
2-2	Comparative data on HP products before and after applying CE	28
4-1	Expected resistance level in different departments of the companies investigated	50
5-1	A function-by-phase matrix	98

List of Appendices :

LIST OF APPENDICES

APPENDIX		PAGE
I	Format of the Primary Questionnaire Used for the Industrial Survey	127
II	Format of the Secondary Questionnaire Used for the Industrial Survey	130
III	Data Analysis of the Findings of the Primary Survey	136
IV	Performance Metrics for Measuring CE	138

GLOSSARY OF TERMS

Bridge - An interconnection device that can connect Local Area Networks (LANs) using similar or dissimilar media and signaling systems.

Computer-Aided Design (CAD) - The use of computer-based tools to assist in the physical layout of electronic designs, including preparation of manufacturing tooling.

Computer-Aided Engineering (CAE) - The use of computer-based tools to assist in one or more aspects of electronic design, from initial detailed design specification through physical layout and test.

Computer-Aided Manufacturing (CAM) - The use of computer-based tools to program, direct, and control manufactured items.

Concurrent Engineering (CE) - Defined by IDA Report R-338 titled [Carter & Baker, p2], The Role of Concurrent Engineering in Weapons System Acquisition, as " a systematic approach to the integrated, concurrent design of products and their related processes, including manufacture and support. This approach is intended to cause the developers, from the outset, to consider all elements of the product life cycle from conception through disposal, including quality, cost, schedule, and user requirement."

Defense Advanced Research Projects Agency (DARPA) - A Department of Defense agency that began a study in 1982 to look for ways to improve concurrency in the design process.

Electronic Mail (e-mail) - A program, commercial, or public domain, that facilitates the electronic distribution of messages and data to addressed subscribers on a network.

Graphical User Interface (GUI) - A GUI, as opposed to a text-based interface, displays programs on screen in graphics mode, usually allowing several programs to be displayed in separate windows on the screen. The programs have a consistent user interface that makes use of pull-down menus, dialogues boxes, and graphical objects such as icons, scroll bars, and buttons.

Groupware - The purpose of groupware is to provide both structure and support to aid users in working together with their computers as tools. One definition for it might be "software for the group".

Institute for Defense Analyses (IDA) - Responsible for publishing the report (IDA report R-338 - [Carter & Baker, p2]) that first coined the term "concurrent engineering."

Just-In-Time (JIT) Manufacturing - A production system where materials or parts used in manufacturing are brought to the work site just as they are needed for assembly, not maintained in inventories.

Local Area Network (LAN) - Communications network that serves users within a confined geographical area. It is made up of servers, workstations, a network operating system, and a communications link.

Materials Requirements Planning (MRP) - An approach to inventory management that usually draws on supplier's information to frequently update forecasts of materials needs so that production plans can be made.

Network - A system used to connect multiple computers together so that they can communicate and exchange information.

Product Information Management (PIM) or Product Data Management (PDM) - A special type of software created to manage the vast amount of information such as electronic documents, drawing data, etc. generated in a concurrent engineering project.

Private Automatic Branch Exchange (PABX) - An automatic telephone switching system for private exchange.

Printed Circuit Board (PCB) - A common way of packaging electronic designs in which the discrete components and integrated circuits are mounted on a glass epoxy-type "board."

Quality Function Deployment (QFD) - An approach to design using matrix charts to carefully define customer requirements and to focus efforts on meeting them rather than simply manufacturing to a set of predefined specifications.

Reverse-Engineering - The process of taking an existing, well-established engineering design or technology of a particular application and using it in a different application.

Router - It is a device specifically designed to interconnect remote Local Area Networks (LANs).

Triangulation Method - A compatibility procedure designed to reconcile the qualitative and quantitative methodologies by eclectically using elements from each methodology to resolve a hypothesis.

Wide Area Network (WAN) - A data network typically extending a LAN (local area network) outside the building, over telephone common carrier lines to link to other LANs in remote buildings in possibly remote cities.

1. INTRODUCTION

South Africa is now back into the international marketplace after decades of isolation. For many companies, the change is going to be characterized by increased competition. New competitors are no longer "waiting in the wings". Instead, they are entering the S.A. market and will present serious competition to the local companies.

Faced with the increasing competition, the South African Electronics Manufacturing Industry, and in fact, most of the other industries, be it chemical or automobile, will have to review their traditional ways of running their businesses if they still want to compete in that global market - a market dominated by world leaders like Japan, USA, Germany, Taiwan, etc.. Many South African companies accept late development, numerous development iterations and production teething problems as the norm for introducing new products, without realizing the severe cost impacts of these deficiencies. As more and more companies are learning from the leaders, they are discovering that they must be competitive both in engineering and manufacturing to survive in the world-wide arena. Customers expectations have increased in demanding high-quality, functional, low cost, and user-friendly products first time. There is therefore little time to waste in solving manufacturing problems, or in redesigning products for ease of manufacture, since product life cycles have become very short because of technological breakthroughs and / or competitive pressures. There is a critical need for these South African electronics companies to improve their manufacturing competitiveness.

The hypothesis is that Concurrent Engineering (CE) can give these electronics companies the competitive edge that they desperately need. According to Shina [Shina_1,p1], Concurrent Engineering is the earliest possible integration of the overall company's knowledge, resources, and experience in design, development, marketing, manufacturing, and sales into creating successful new products, resulting in high quality and low cost, while fully meeting customer expectations. The most important results of applying CE is the shortening of the

time for the product concept, design, and development process by changing from a serial process to a parallel one. CE has nowadays become an important element of global competitiveness. The new product design and development life cycle has been adopted by many manufacturing companies to shorten new product introduction cycles, and to quickly increase production volumes.

Furthermore, CE is not seen in the same negative light as automation. CE does not replace the jobs of people. Instead, it focuses on the design stage of manufacturing and therefore increases competitiveness by involving the skilled employee, without threatening job security, or requiring wage increases. CE does not conflict with good business practices nor require a large investment in new equipment.

The successful implementation of CE in an organization will enable that organization to gain a distinct competitive advantage. According Ramana Reddy, director of West Virginia University's Concurrent Engineering Research Center, which is funded by the US Defense Department, the whole world is coming to the conclusion that something like CE must be done [Woodruff, p65]. By the year 2000, proponents of CE believe few companies will remain untouched. And Reddy predicts that CE will unleash the most wrenching cultural upheaval in manufacturing in 50 years.

1.1 Objectives of the Research Study

The objectives of this research are the following :

- 1) To determine the level of awareness of the CE concept among the managers of South African electronics manufacturing companies.
- 2) To determine whether CE can be successfully applied in the South African electronics manufacturing companies.
- 3) To derive guidelines for managers of the South African electronics manufacturing companies who wish to implement the CE concept.

1.2 The South African Electronics Industry & its Competitiveness

The South African workforce as a whole is not as productive as our global competitors. Labour productivity has risen by less than 10% since 1975 [Osborn, p22], but there have been wage increases for other reasons, which have contributed to a 600% product unit cost increase since 1975, compared to Taiwan whose cost has little more than doubled. This has reduced South Africa's international competitiveness. Given the political situation and the high expectations of the general workforce from the new government, a reversal of this trend is not foreseen [Minnaar_1, p13]. Companies that are meeting the tide of lower-cost products by cutting prices and inevitably, their own profit margins, and are also cutting the workforce to beef up profits, are adopting the wrong strategies to compete in the global market.

Advanced technology research is supported and funded by governments in foreign countries. The United Kingdom has the Alvey program, Europe the ESPRIT program, Japan the Fifth Generation Computer program [Minnaar_1, p11]. South Africa cannot afford high technology funding because of the recession and the priorities of the new government in financing the Reconstruction and Development Programme (RDP). The economy needs more exports, but South Africa's productivity is too low and unit costs too high to compete internationally. The South African electronics manufacturing industry is severely handicapped in its competition with other manufacturers. This does not mean that South Africa is completely out of the race. There will always be niche markets where South Africa will be able to compete, if South Africa increases its competitiveness. South Africa's competitors have already identified CE to be an important part of their drive for more competitiveness. In 1988 the DARPA Initiative in Concurrent Engineering (DICE) was launched in the United States to encourage and research the practice of concurrent engineering in the US military and industrial base. By the end of 1991, DARPA (Defense Advanced Research Projects Agency) had spent US \$60 million on the DICE project. A consortium of more than a dozen industries, software companies and universities still continue with this research [Carter & Baker, p2].

The Americans have realized the critical need to develop concurrent engineering as a way to improve their manufacturing competitiveness.

The productivity of the general workforce and other factors mentioned above have a direct bearing on the need for the implementation of concurrent engineering. The local electronics manufacturing industry cannot expect to make great leaps in competitiveness based on increasing the productivity of its workers. The competitive drive needs to come from other areas, of which concurrent engineering is one.

The South African manufacturing industry would therefore be unwise to ignore concurrent engineering as a means of achieving better competitiveness.

1.3 The Need for Change in the Electronics Industry

Some years ago, the world of engineering changed slower than today. Products models remained unchanged for ten to fifteen years. Engineering was simpler, everyone understood the manufacturing process (it changed slowly), standard parts were purchased. The engineering force was small and communications flowed freely between design and manufacturing. Competition in the local and global marketplace was much less than today.

Today the situation is markedly different. Now a host of new manufacturing technologies and companies are "mushrooming" everyday. Never has competition for manufactured goods been keener: Japanese companies are extremely aggressive and competitive. The newly industrialized countries (NICs) such as Korea, Taiwan, Thailand, Singapore and Malaysia are attempting to raise quality to compete on equal terms with US manufacturers, while the Eastern Europeans are starting to produce a number of cheap products that meet the demands of consumers. There is a greater need for South African manufacturers to export goods to stimulate growth. In order to export, South African manufacturers must make better products with shorter

development lead times and with improved inherent quality. It is no longer merely a question of cutting manufacturing costs - itself a major challenge - but of refocusing the direction of the business so that it responds to the needs of customers. Because of fierce competition, customers are able to find better products at lower prices from other sources. The objective must be to put customer's requirements first. Such a change demands a major shift in corporate culture.

Furthermore, global economic patterns and tendencies have changed dramatically in the past decade alone, and will no doubt continue to do so. One of the significant changes has been the emergence of offshore manufacturing. This has been made possible by high technology, global communication and the utilization of third world labour markets. It is not necessary for the larger organizations to have their whole operation in one place, they can relocate individual departments to where they can operate at the lowest cost. One example is data-processing that is being done in Ireland and Barbados for large organizations like General Motors [Stewart, p35].

South African manufacturers have to compete with high technology manufacturing facilities erected in third world countries. The latter, in addition, have higher productivity with lower labour costs. One way to meet this competition is to improve quality, reduce time to market and reduce unit costs. Changes in the South African environment have had a severe impact on the electronics industry. It is now, more than ever, critical that the industry becomes competitive, without the help of government subsidies.

New product development cycles have been undergoing changes that are accelerating rapidly. Increases in the rate of technology change and, competitive pressures are making the introduction of new products very critical to the financial future of companies, and making older products obsolete much faster. In the electronics industry, the life cycle of the typical product is short because of the impact of technological change. The investment in new product development is therefore much higher in the electronics industry than in other

industries. These development costs tend to be highest during the startup phase and become less as the products mature. Costs vary from about 5% of revenues from established products, to more than 25% of revenue from new market segments [Shina_2, p24]. The technology changes in the electronics industry stem from many different sources: faster operation and larger capacity of electronics components, such as memories and microprocessors, new techniques in information storage, retrieval and display, and new materials and processes in fabrication such as printed circuit boards and plastics. In addition, global competition is forcing new products on to the market at a much higher rate. New products quickly become old products as manufacturers throughout the world rush to produce very similar products through reverse-engineering techniques.

1.4 The Need for Concurrent Engineering in the Electronics Industry

Companies relying on traditional ways of designing new products and bringing them to market are being shocked into action by competition from world-class companies which are working smarter, not harder. Many companies in Japan, the United States, and elsewhere are now doing just that [Rosenblatt_1, p23].

As the technology explosion in electronics continues, it is becoming increasingly important to introduce new methods for new product introduction. If traditional methods for the design and manufacture of products are used, products could become obsolete prior to their production and introduction into the market place. This is the reason why engineering for electronics systems is undergoing a transformation. In order to compete successfully around the world they have to adopt, like Japan and United States, techniques for quickly developing and manufacturing high-quality products. These techniques come under the heading of Concurrent Engineering.

In the fast-track electronics sector today, the accepted rule of thumb is that the first two manufacturers to get a new-generation product to market capture as much as 80% of the business. McKinsey & Co. [Woodruff, p64] calculates that

going 50% over budget during development to get a product out on time reduces its total profit by only 4%. But staying on budget and getting to market six months late reduces profits by a third.

Implementing CE is not without a price - a price that many people and organizations are not willing to pay. That price is the change to a new way for engineering to operate. For most organizations, change in the basic mode of operations is not welcome. People desire a change in results without changing the way they work. Managers do not want to change their ways, nor do engineers. The known is preferred to the unknown. Any change presents elements of the unknown. Unless proper measures are taken to prepare people to cope with a changed CE environment, any attempt to make CE work is bound to fail. This is precisely the kind of soft issue that prompted this research in order to offer practical guidelines to overcome the problems encountered in adopting concurrently engineering.

2. LITERATURE REVIEW

This part of the thesis is more than a mere literature study of CE. It assimilates information from diverse sources into a description of CE. The aim of this section is to provide the reader with an in-depth description of concurrent engineering and its related issues.

Concurrent engineering is not a new concept. Many companies will argue that they have been practising concurrent engineering for a long time and, to varying degrees. They are right. Indeed, Japanese consumer electronics manufacturers have practised it for years without giving it a special name; they consider it simply good business and engineering sense. It is important at this point to stress the fact that CE is not a product - it's a process. CE is a people, discipline, procedure, methodology, and management issue.

2.1 History of Concurrent Engineering

In the 1980s, US companies began to feel the effects of three major influences on their product development:

- Newer and innovative technologies
- Increasing product complexities
- Larger organizations

Companies were forced to look for new product development methods. One of the most significant events in the concurrent engineering time line took place in 1982, when the Defense Advanced Research Projects Agency (DARPA) in the United States began a study to look for ways to improve concurrency in the design process. Five years later, when the results of the DARPA study were released, they proved to be an important foundation on which other groups would base further study.

In the summer of 1986, the Institute for Defense Analyses (IDA) Report R-338 coined the term concurrent engineering to explain the systematic method of concurrently designing both the product and its downstream

production and support processes. The IDA Report provided the first definition of concurrent engineering and it goes as follows [Carter & Baker, p2]:

“Concurrent engineering is a systematic approach to the integrated, concurrent design of products and their related processes, including manufacture and support. This approach is intended to cause the developers, from the outset, to consider all elements of the product life cycle from concept through disposal, including quality, cost, schedule, and user requirements.”

This definition is now widely accepted. However, many have recognized, from different viewpoints, the need for closer working relationships between engineering functions. Several have given names to the process according to the path or view they pursued. Thus we have Concurrent Engineering, Simultaneous Engineering, Parallel Engineering, Design for Manufacturability, Design for Excellence, or Design for “X”, Team Design, Transition to Manufacturing, Integrated Product Development, among others. Consequently, different definitions have been given to the same process and they all have the following common elements in them [De Souza, p37] :

- design engineering function working more closely with some or all of the other engineering functions
- people, their coordination and involvement
- communications (between all those involved on a project or product)
- process (both the manufacturing and the management process) and
- time (being the time to market - development life cycle).

Each contributes toward achieving the strategic business goal - namely, to introduce the right product, in advance of competitors and at precisely the right time, and to include more features and provide better performance, whilst still meeting the appropriate levels of cost and quality.

Whatever the process is called, Concurrent Engineering continues to develop as the industry continues to better understand the relationships, communications, and organizations necessary to produce the best product at a competitive cost.

2.2 Concurrent Engineering versus “Over-the-wall” Engineering

For most of their history, US (and South African) electronics companies have usually operated by tossing new products developed in their design groups "over the wall" to manufacturing. The product engineering and manufacturing departments then took on the task of ensuring that the product was able to be manufactured.

This process inevitably leads to rework. For reasons of manufacturability, for instance, part dimensions and tolerances might have to be changed. But there is another problem in this division of specialities: manufacturing will not know which dimensions and tolerances are critical to the performance of a product, nor which can be relaxed to improve the manufacturing efficiency and yield. Thus, only "make or break" manufacturing characteristics are changed - because it is better to accept a marginally manufacturable product than to jeopardize proven (during prototyping) performance to make the unit easier to manufacture [Rosenblatt_2, p37].

Any changes also mean that documentation, such as parts lists and configuration and assembly drawings, must be altered, too. Tooling may have to be reworked and contracts possibly renegotiated with suppliers. Historically, once the product of most electronics companies got to the field, marketing and field service organizations recorded customer complaints about its performance compared to its advertised specifications. Some also considered service technicians' reports about repairs and, defect rates of parts and assemblies. In many cases, however, companies have still not learned from their past mistakes. Often, they fail to set up communication links to notify the design and development departments of deficiencies discovered in the field.

This happens because many companies do not have the management skills, resources, or tracking systems to identify deficiencies. But engineers are also overwhelmingly biased in favor of fixing problems in current products, rather than in preventing future problems by finding and eliminating root causes in the underlying development process.

Thus, companies tend to turn out new products with the same (low) levels of customer satisfaction, quality, and cost. They end up fixing problems again and again, while patting themselves on the back for their knowledge and experience in solving the "*déjà vu*" problems for each product. Problems of one generation sometimes turn up in the next [Rosenblatt_1, p24].

Alarmed with the lack of competitiveness in the global market, the leading US electronics companies decided they had to make quantum jumps in quality and cycle times. What they discovered is that "all roads lead to a few keys to competitiveness," says Terrance R. Ozan, director of manufacturing consulting services at Ernst & Young [Woodruff, p65]. "If you cut through the buzzwords, the strategic issues are time to market and quality, plus flexibility in responding to changing customer needs and market forces - and then cost. And it is these precise issues that Concurrent Engineering addresses."

The concept of CE is not entirely new. For many years, some companies (mainly from Japan) have been taking advantage of the benefits of increased communication very early in the process of designing a new product and getting that product to market. This communication has been between all of the various functional groups within the company's organization involved in the new product and its related manufacturing process. The underlying message of the concept of CE is, that it is extremely beneficial to design the processes that are required to produce a product at the same time that the product itself is being designed. Recent developments in both hardware and software are adding to the collection of tools available to increase the capabilities of many companies to utilize "paperless" Concurrent Engineering systems [Foreman, p92]. In these systems, all engineering work, from design through production and inspection, is carried electronically via interconnected workstations. In order to take full advantage of the available tools, some changes may be required in a company's organization and the way that people do their work.

According to the data from the National Institute of Standards and Technology, Thomas Group Inc., and the Institute of Defense Analysis [Maliniak, p37], CE

methodologies can reduce development time by up to 70%, result in up to 90% fewer engineering changes, reduce time to market by up to 90%, and result in a quality improvement of up to 600%.

2.2.1 The Product Development Process

The present sequential (over-the-wall) method of product development is like a relay race. The research or marketing department comes up with a product idea and hands it over to design. Design engineers craft a blueprint and a hand-built prototype. Then, they throw the design "over-the-wall" to manufacturing, where production engineers struggle to devise a way to bring the blueprint to life.

Often this proves so daunting that the blueprint has to be sent back for revision, and the relay must be run again - and this can happen over and over. Once everything seems set, the purchasing department calls for bids on the necessary materials, parts, and factory equipment - stuff that can take months or even years to get. Worst of all, a design glitch may turn up after all these wheels are in motion. Then, everything grinds to a halt until yet another so-called engineering change order is made.

Apart from wasting time, this approach fosters bureaucracy. Layers of jobs sprout up around each departmental function [Port & Schiller, p65].

On the other hand, the entire development process in a CE environment is managed by a cross-functional team of experts from all relevant departments, including marketing, design, and manufacturing. The central notion is that the team is responsible for conceptualizing the product correctly up front. Each expert ensures that the problems that could later occur in his / her department are, to the greatest extent possible, avoided, thereby dramatically reducing later changes.

With all the important areas represented right at the start, the cross-functional team conceives the product correctly, manages parallel processing, and cuts delays and waste. This contrasts with the traditional approach which kept the marketing, engineering design, and manufacturing phases separate and performed them sequentially. Figure 2-1 below diagrammatically contrasts the product development process in the sequential environment with that of the concurrent environment.

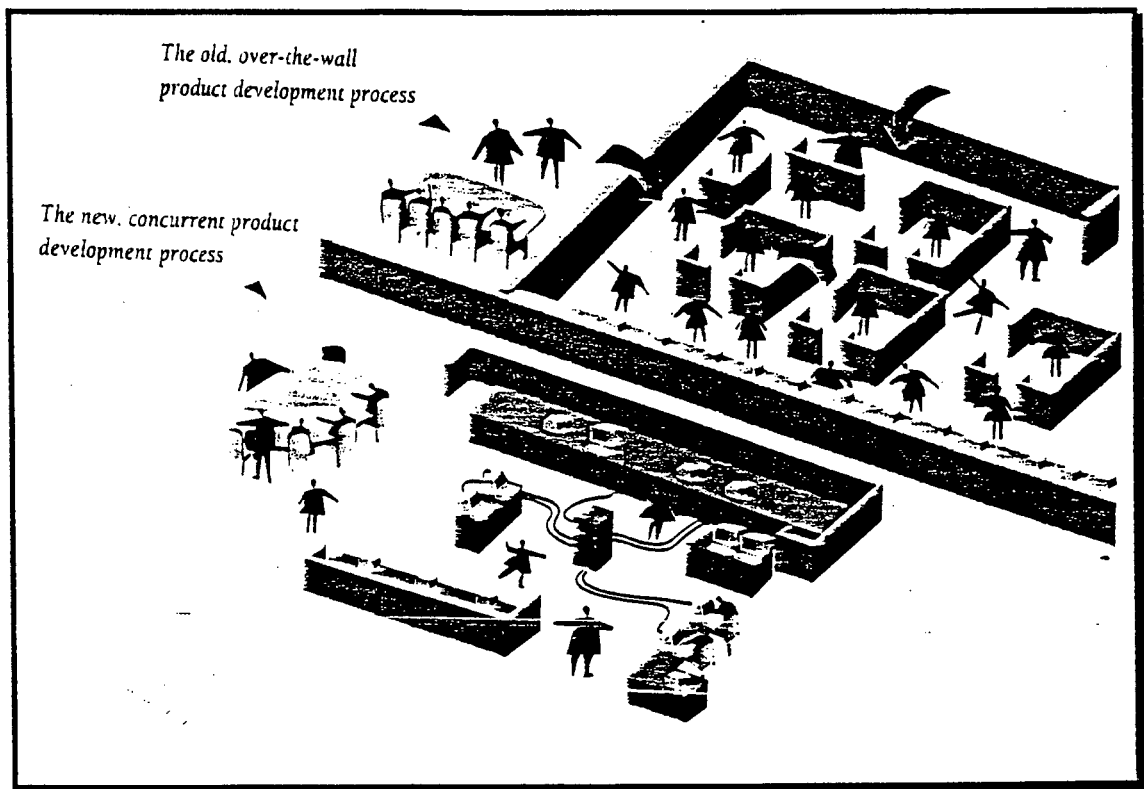

Figure 2-1 : Diagrammatic representation of the sequential and concurrent product development processes [Carter&Baker, p34]

Figure 2-2, next page, shows the involvement of the functional departments at different stages of the product development cycle in both the conventional and concurrent engineering environments.

Sequential (or conventional) engineering is a neat step-by-step approach and is therefore simple to manage whereas CE is simultaneous and consequently more complex. Considerable attention is therefore required in planning a CE program.

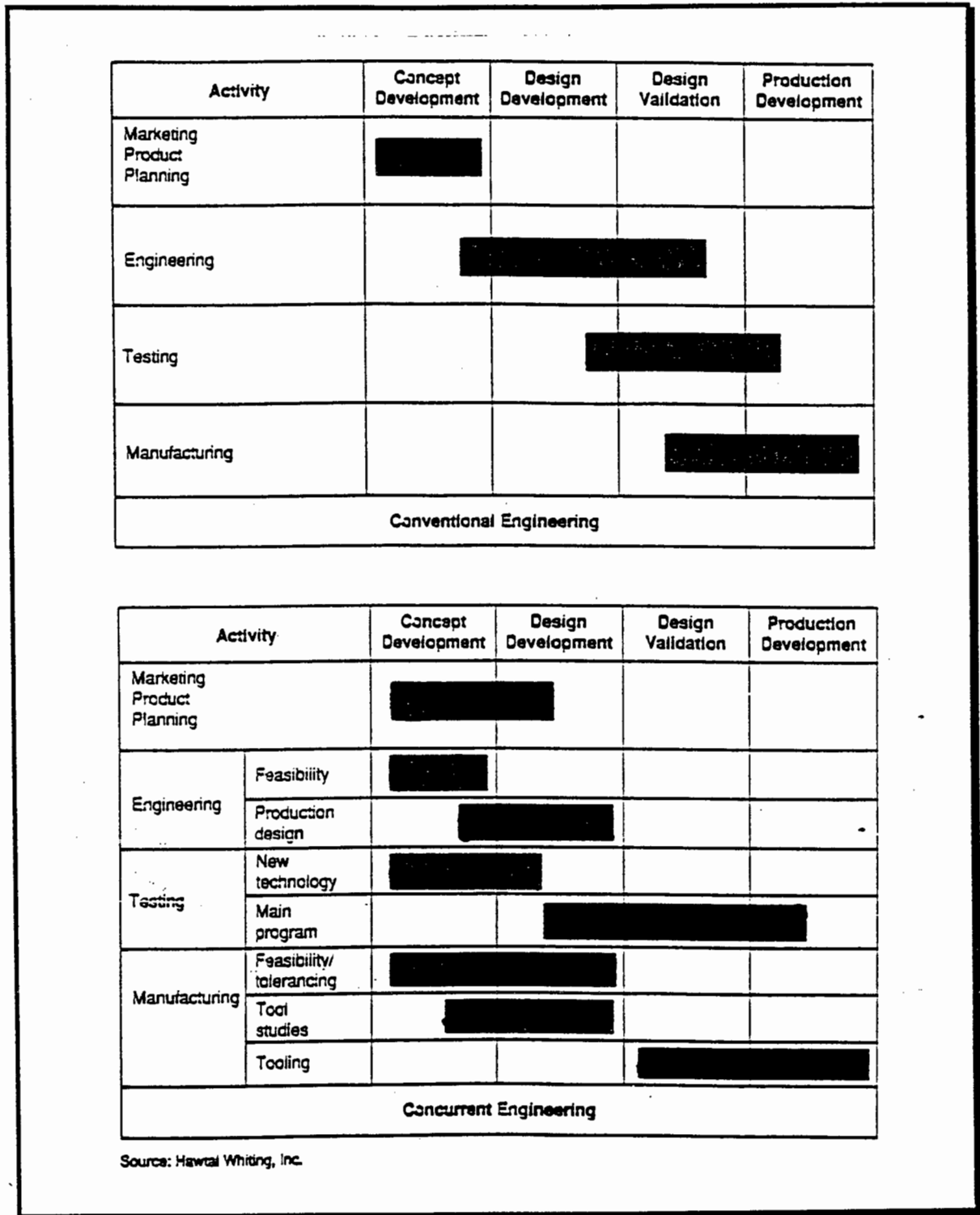

Figure 2-2 : With conventional engineering, functions are sequential, but with CE, jobs are done concurrently [Hartley, p17]

For practical purposes, South African companies have traditionally approached the product development cycle in much the same way - i.e., sequentially. Each function,

from design through manufacturing and all the way to distribution, is taken one step at a time, in virtual isolation from its neighbours. It is time for these companies to review their approach to developing new products if they still want to be in business in the years to come.

2.2.2 Time-to-Market

Time-to-market is becoming a more important competitive issue for manufacturing companies, and in the 1990's it may be the single most critical factor for success across all markets. Managers have long known that "time is money", but only recently has that concept been widely accepted as a competitive advantage across all markets and product lines.

McKinsey & Co. consultants produced a study showing that a product that is six months late to market will miss out on one-third of the potential profit over the product's lifetime [Vesey, p22]. Table 2-1 below summarizes the McKinsey's findings.

Table 2-1 : Cost of Arriving Late to Market

If your company is late to market by:	6 month	5 month	4 month	3 month	2 month	1 month
Your gross profit potential is reduced by :	-33%	-25%	-18%	-12%	-7%	-3%
Improve time-to-market by only 1 month, profit improve by:	+11.9 %	+9.3 %	+7.3 %	+5.7 %	+4.3 %	+3.1 %
For revenues of \$25 million, annual gross profit increases:	+\$400 K	+\$350 K	+\$300 K	+\$250 K	+\$200 K	+\$150 K
For revenues of \$100 million, annual gross profit increases :	+\$1600 K	+\$1400 K	+\$1200 K	+\$1000 K	+\$800 K	+\$600 K

Source : McKinsey & Company

Charles Lamb, director at Emhart Corporation in Connecticut, USA [Wesley, p3], stated that using CE techniques on an introductory level has reduced by one third the time it takes for a line of Emhart product to reach the market. Lamb maintains that communications already goes on in America industry, but that

most of it occurs accidentally, during chats at the coffee machine. But he cautions that competition and shorter product life mean that companies are rushing to get to the market place faster. "The accidental communication route is no longer adequate."

The importance of designing products on time, and quickly increasing production to mature levels, cannot ever be over-emphasized. This is especially true since the end-point of the product life cycle is fixed in time, because of technological issues beyond the control of the company. Figure 2-3 below illustrates this point [Shina_1, p32]. Any slip in release to production, or an early production problem, translates to lost sales that are not recovered at the end of the product life cycle. It is worthwhile noting here that a 1-month slip in product development means one less month of mature sales.

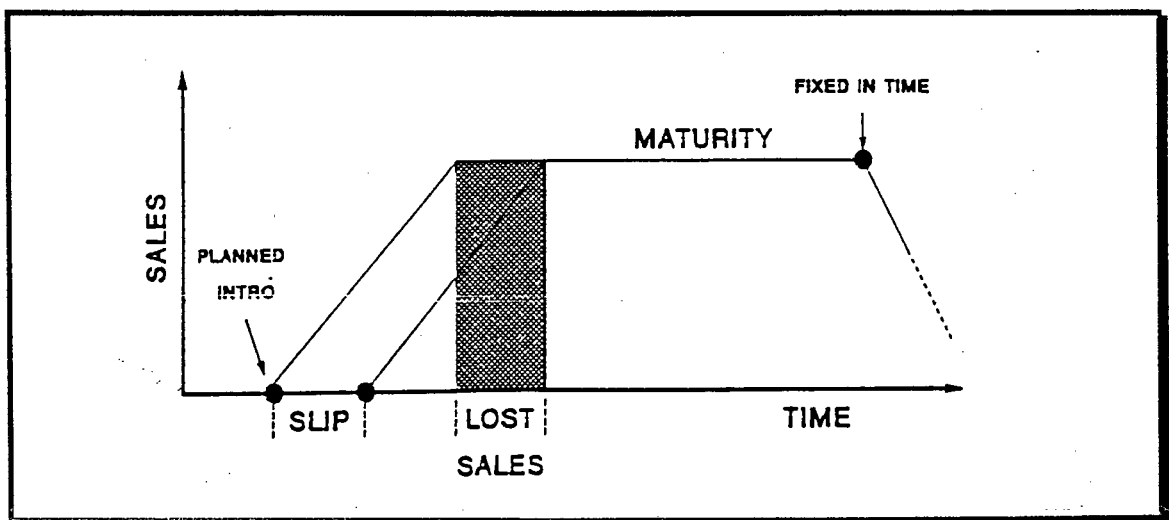

Figure 2-3 : Product development slippage effects on life cycle sales.

According to Brazier [Brazier, p52], speed is a key to competitiveness : studies have shown that over 80% of market share in a new product category goes to the first two companies that get their products to market. And a six-month overrun in time during the design stage today will result in a 33% loss over the life of the product.

Based on these projections, it makes sense to put the most serious efforts into the product development cycle. Getting to market quickly can mean the difference between getting prime sales as opposed to coming to market after competitors are

already there and selling in a "mature sales" environment. Overall, concurrent engineering brings greater speed and productivity to a company.

2.2.3 Product Design Iterations (Changes)

Today's development methodology is still based on a sequential process. Typical of this process is little, if any, interaction among disciplines, which leads to problems later in the development cycle. Figure 2-4 below [Sprague, p7] shows a typical flow of effort between disciplines A, B, C, and D. A sequential flow like this can lead to multiple design iterations, as problems are discovered later in the process. These iterations not only consume much of the entire team's effort, but also stretch out the time required to fulfill all the design requirement.

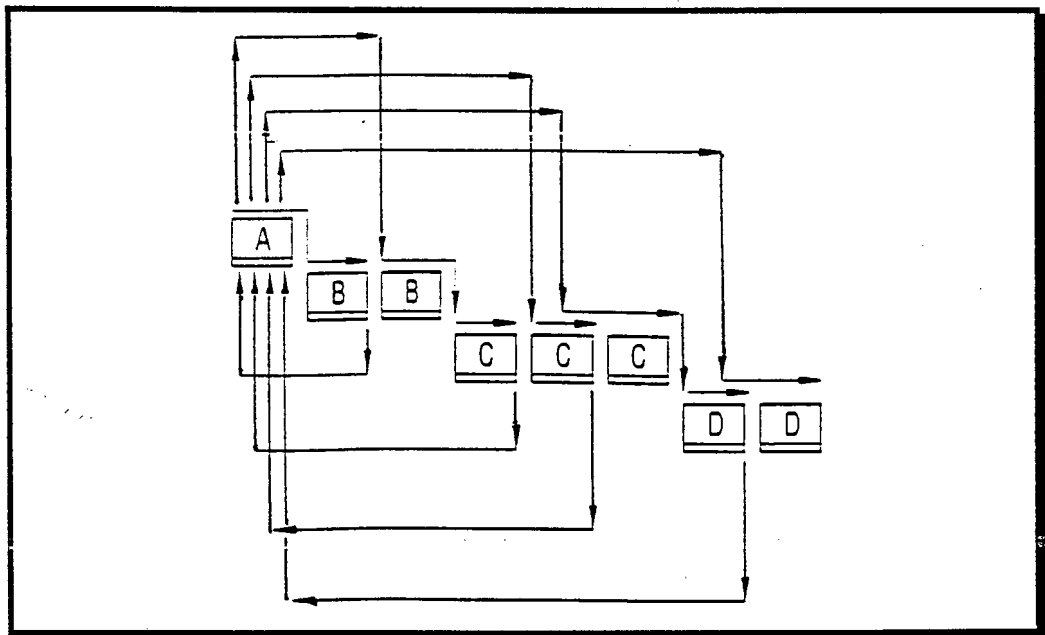

Figure 2-4 : The sequential design process

The cost to US manufacturing of schedule delays, rework, scrap, late deliveries, additional inspection, warranty cost, administrative cost, and loss of market share as a result of the sequential process is staggering. Some estimates range as high as \$440 billion lost due to the above hidden costs of this functionally oriented approach to manufacturing [Charles; p68].

In contrast to serial design and manufacture is CE. Figure 2-5 [Sprague, p8] shows how in a CE environment, all constraints and requirements from all disciplines are satisfied as the design progresses. Practising CE ensures that all engineering disciplines can do their work in parallel, without the risk that a change made somewhere else will make their work obsolete. Hence, there is no reason for the time-consuming multiple iterations common in the sequential process. The CE development process results in an optimal design solution because the team working in parallel can rapidly verify multiple options.

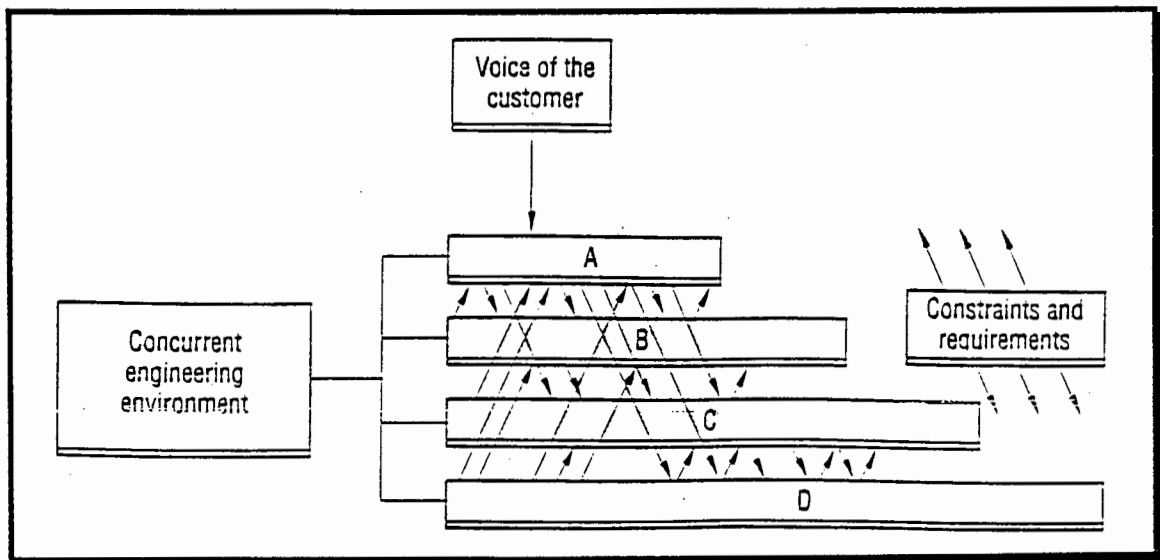

Figure 2-5 : The concurrent engineering environment

In a study conducted by Dataquest [Zangwill, p41], the costs of change for major electronics products in each phase of its development was found to increase tenfold from design to final production as follows :-

During design.....	\$1,000
During design testing.....	\$10,000
During process planning.....	\$100,000
During test production.....	\$1,000,000
During final production.....	\$10,000,000

A change, which costs \$1,000 during design, costs \$10,000 if made during design testing. If made while the product is in process planning, the same change costs \$100,000, and in test production it costs \$1,000,000. In final production, the cost would be \$10,000,000 (\$10 million)

The \$10 million figure may seem high, yet if a sizable number of products have already been made and have to be altered, the cost could easily equal that. In one of the General Electric (GE) refrigerator models, changing the failing compressors cost GE over \$400 million. For its midrange AS/400 computer, IBM determined that a change in the testing phase cost 13 times more than a change in the early design phase, and that a change after installation at a customer site cost 92 times more [Zangwill, p41]. These are data for a very well-designed, highly modular product, so for many other products, the numbers might be even higher.

Robert Winner of the Institute for Defense Analysis in United States [Zangwill, p42] notes that the concept development phase spends only 1% of the total cost of the project, but it determines 70% of the life-cycle cost of the product. When the advanced development phase is completed, 7% of the development cost has been spent, but 85% of the life-cycle costs are determined. Winner further states that getting the job done right the first time is essential. Do the upfront work thoroughly, even at the price of lengthening that phase, because correcting an error or omission in a later phase can be so expensive. As Paul Noakes, vice president of Motorola says [Zangwill, p43], it is better to add five extra engineers at the beginning than to add 50, often with overtime, near the end.

Because decisions made during design lock in the bulk of later spending, doing design correctly is critical. According to Brazier [Brazier, p53], in a typical electronics project, a 50% cost overrun in the product development cycle results in only a 3.5% loss of profit. However, a product cost that is 9% too high translates into a 22% loss of profit, and a product that is shipped six months late loses 33% in after-tax profits. Figure 2-6, next page, shows these figures graphically.

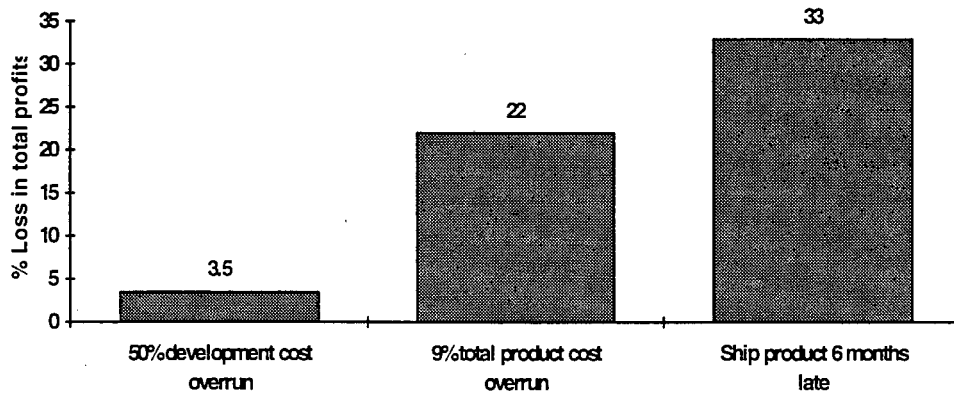

Source : McKinsey & Co.

Figure 2-6 : Lost profits when a product is not competitive

Concurrent-Engineering, as an approach to product development, holds out the hope of consolidating competitive advantage by reducing the time between product development and product costs; increasing quality; and augmenting market share.

2.3 Who Should Adopt Concurrent Engineering ?

Who should adopt Concurrent Engineering? - Virtually any organization involved in the manufacture of new products on any scale [Carter & Baker, p5]. Small firms with 10 to 50 employees are probably already doing it unconsciously, and if they are not doing it, they should be. The need for formal CE is more critical for larger organizations.

2.4 Successful Application of Concurrent Engineering in Overseas Companies

Concurrent Engineering has been applied successfully in many American major companies and some European companies. Most companies in Japan practise CE but they do not have a name for the approach - it has been so embedded in the company culture for so long that for them it is just common sense. It is clear that Japanese companies are able to develop products more quickly than their American competitors, and with higher quality. In many industries, their products

are the benchmarks. This competitiveness results from a number of factors, such as a loyal work force, dedication to customers' expectations, and the use of improved methods to develop products. There is a reluctance from the Japanese to share details about this approach because, as the key to shortening time-to-market, concurrent engineering is believed to be the critical factor in competitive leadership for Japan ! [Evanczuk, p22]

The case studies that follow are in the form of comments from CE practitioners on the achievements of their CE program in some US based companies.

NCR Corporation :

NCR Corp., a manufacturer of terminals for checkout counters (cash-registers) based in Atlanta, USA, used to develop products like most manufacturers in a series of steps, starting with design and engineering, then letting out contracts for various materials, parts, and services, then finally going to production. Each step was largely independent of the others. Changes made at any post-design stage, especially after production started, caused major traumas. Late fixes would ripple back through a project, causing everything that had gone before to be reworked. That would delay the product and push its costs through the ceiling. So NCR decided to test a new method: do everything concurrently.

In January 1987, NCR tried concurrent engineering for its latest machine. The production rolled out 22 months later - half the normal time. The terminal has 85% fewer parts than its predecessor and can be assembled in two minutes, or one-fourth the normal time. That convinced NCR. It tore down the wall that separates most design and manufacturing departments. Now, all the plant's 100-odd engineers are located in a pool of identical cubicles. When a project starts up, the engineers play musical cubicles. The specialists involved in design, software, hardware, purchasing, manufacturing, and field support all work side by side and compare notes constantly. This makes for more synergy, curbs late fixes, and achieves what William R. Sprague, NCR's senior manufacturing engineer in Atlanta, calls "the overriding factor" - getting products out on time [Woodruff, p64]

American Telephone & Telegraph (AT&T) :

NCR isn't alone in switching to CE. American Telephone & Telegraph (AT&T) Co. latched onto the concept when it redesigned its main 5ESS electronics phone-switching system. The total "cycle time" from conception to production was trimmed by more than half from the normal three years, and manufacturing defects plunged as much as 87%. AT&T believes that their survival depends on CE. [Rosenblatt_1, p22]

Texas Instruments :

Texas Instruments' Tim Bogard, noted that before the move to CE, 50 to 90% of all significant drawings had missing or incorrect dimensions at release. He also stated that no more than 10% of design data was used by analysis or manufacturing. Since implementing CE, manufacturing and analysis use 100% of the design data, and engineering drawings have no missing or incorrect dimensions [Anonymous_1, p14].

Hewlett-Packard (HP) :

Hewlett-Packard (HP) Co.'s Colorado Springs Division developed their 100-MHz Digital Oscilloscope Model 54600 using CE. From idea to finished product, it took HP one-third the time to complete the project that it would have without CE. "The net result of our CE is that we produced the oscilloscope at the price we aimed for." said Roy Wheeler of HP. He further added that their cooperative effort made it possible to package the components in just a few modules that can be assembled into a complete unit in less than 18 minutes. As in the development of the their 54600 oscilloscope, the first step in any of their CE projects is to organize people from all sections of the division into project management teams under the leadership of the R&D project manager. Some team members are assigned to a project on a full-time basis, and others are assigned to several teams at once. Usually, marketing and R&D start out the process by defining what the product should be. Manufacturing and reliability engineers join in when early implementation decisions are being made. To select sources and technologies purchasing and materials engineers come on board, while accounting provides cost and investment information as appropriate.

HP Colorado Springs Division uses many computer-based tools, largely HP-developed, in its concurrent engineering. These tools are linked electronically to machine tools, board fabrication equipment, automatic component assembly machines, and board-level test equipment. "All of them help us do our jobs more efficiently, though none of them is required for CE. All that is required for CE is people working together." explained Roy Wheeler [Wheeler, p32].

Hewlett-Packard (HP) :

In designing the DesignJet Plotter Chassis, Hewlett Packard plotter division made the concept a reality as a result of a significant engineering effort that involved concurrent iterations of component design, assembly tool design, and assembly process development. Because of the complex interactions of the components within the chassis, the assembly process and assembly tooling became as critically important as the component designs. All three areas required simultaneous development. The design of the chassis was largely driven by customer's requirements for good print quality. The concept represents a significant improvement in performance and cost over previous chassis concepts. It achieves twice the guideway straightness of any previous solution. It also represents a significant cost savings in the manufacturing of the components [Longust, p28].

Sun Microsystems Inc. :

Sun Microsystems Inc. is a leading supplier of client/server computing solutions which feature networked workstations and servers that store, process and distribute information. Sun Microsystems applied the concurrent engineering approach when developing its product known as the "SparcStations SLC." At the time of its announcement, the SLC was unique in the industry for being the first workstation listed at under \$5,000. The system was designed, prototype, qualified and shipped in volume, within a record 10 months. Four objectives (low cost, minimal desktop area, short time to market, and quiet) were developed by the marketing department as a result of customer feedback from previous products. In order to meet them, within the required market window, CE was chosen as the only structure capable of assuring success. Along with the organization of tactical teams the creation of the programs communications infrastructure was required. Sun as a company is tied

together via a computer network. The predominant mode of communications is electronics mail (e-mail). Utilizing this method, team aliases were set up that allow for a single memo to be addressed to the team with one command. This capacity was used extensively to keep team members informed of current program status, action items that need immediate attention, and it allowed for a wide distribution of common issues in real-time. Sun's sophisticated communications infrastructure had a major contribution into the success of the CE program [Siegel, p15].

Cisco Systems Inc. :

Just another Silicon Valley start-up in 1984, Cisco Systems Inc. has undergone dramatic growth, much of it attributable to concurrent engineering (CE). Revenues jumped from US \$27 million in 1989 - when this approach was first adopted - to \$70 million in 1990. Cisco makes multimedia and multiprotocol internetworking products : routers, bridges, and terminal servers for wide-area network (WAN) that link geographically dispersed local-area networks (LAN).

Their first router was shipped to a customer on schedule in May 1990. The board test time was 40 minutes - it would have been at least 60 minutes without CE. The test time has since been reduced further to 20 minutes. Today, Cisco still has its weekly review meeting. But now every new product at Cisco is guided by a team whose members come from many groups : hardware and software engineering, marketing, and business development. Each member is involved in every stage of the product cycle. Today, active engineering problems seldom arise; they are avoided by teamwork and forethought [Burnett, p33].

Digital Equipment Corporation (DEC) :

In designing a new, three-button mouse, Digital Equipment Corp., applied CE to the small project. CE allowed the project to cut assembly time by 65% and material costs by 42%. Their next concurrently designed product - the company's TA90 computer storage system, increases reliability by 50% over its predecessor. The design also reduces cost per Mbyte by 50% [Machlis, p37].

Westinghouse Electronics Systems Group :

At Westinghouse's Electronics Systems Group, both design and manufacturing have been put under one manager. To help foster teamwork among both groups of engineers, a shop-floor laboratories has been set up. Outfitted with the same equipment that will be used for production, the labs are a meeting ground where CE teams prove out their designs [Port & Schiller, p66].

Mercury Computers Systems Inc. :

CE has also scored well at Mercury Computers Systems Inc., a Lowell, Massachusetts-based maker of add-on processor boards for VME-bus. The company was able to shorten appreciably the cycle for shipping a new board from design approval to a customer for testing down to just 90 days instead of 125 days it would otherwise have taken [Rosenblatt_1, p23].

Wilkerson Corporation :

Faced with formidable foreign competition and ever more demanding users, Wilkerson Corp., a fluid power company, turned to CE to re-establish leadership in its corners of the field. The CE team that redesigned Wilkerson's line of electronic filter regulator-lubricators in less than 18 months included representatives from design, manufacturing, quality, marketing, and purchasing. Feedback from customers also led Wilkerson's concurrent engineering team to factor design-for-service issues into its plans. Customers preferences helped Wilkerson decide on tradeoffs between features and added costs [Anonymous_2, p18].

Deere & Co. :

Deere & Co. began using CE in the late 1980s and has slashed the previous seven-year cycle time for construction and forestry equipment by 60%, saving 30% of the usual development costs [Rosenblatt_1, p23].

Some other major American electronics companies that have implemented CE are the following :

- General Electric Co.
- Motorola Inc. radio-telephone plant in Schaumburg, Illinois

- Eastman Kodak Co.
- Instron Corp.
- Thiokol Corp.
- Litton Guidance & Control Systems
- Telco System Fiber Optics Corp.
- Abbott Laboratories' Diagnostics Division
- GenCorp Aerojet Electronic System Division
- Symbol Technologies Inc.

An in-depth literature review of three American companies, namely, Hewlett Packard, Chipcom Corp. and Sun Microsystems has also been carried out. The findings from this review are discussed in the following section.

2.5 Findings from the Literature Review

The following case studies are adapted from [Shina_3, p44]. They illustrate an in-depth CE application in the following three American companies: Hewlett Packard and Chipcom Corporation, and Sun Microsystems.

2.5.1 Hewlett Packard (HP)

According to Robert Williams of Hewlett Packard , the development of their HP 34401A multi-meter demonstrates the progress that can be realized when the necessary ingredients are in place and the people involved are given a chance to excel. When developing the HP34401A, the challenge for the HP development team was to deliver the performance of \$3,000 to \$5,000 instruments at a \$1,000 price. Meeting this objective was a vital part of our overall business strategy, says Robert Williams. To do this and still provide growth through satisfactory profit would require a comprehensive and fresh approach to the product development cycle.

The HP3401A Team Formation :

The formation of the 34401A team was done in a number of phases rather than as an immediate and deliberate attempt to define a huge, concurrent engineering team. The initial staffing consisted of a project manager, a mechanical R&D engineer, two electrical R&D engineers, and a manufacturing engineer to review alternatives to the mechanical approach to the product. Four more R&D engineers and a marketing engineer were added shortly to complete phase 1. The second phase involved the assignment of several manufacturing engineers and, subsequently, a manufacturing project manager. Phase 3 followed quickly when the entire development team collocated and management expanded the boundaries so that the team could function as one effort.

Learning to Work Together :

It was not until the entire team was geographically together that the HP team realized that there was something lacking in their product development culture. That something was the skill of working together as a cross-functional team. According to Williams, the technical community is typically not trained in academia to function as team members. Engineers are especially vulnerable to individual competition in undergraduate- and even graduate-level education. As a result, they can sometimes bring a maverick individualism into the workplace that disrupts common sense endeavor, such as concurrent engineering. To overcome some of these challenges, the project team took some collective training in such areas as team development, conflict management, and personality type analysis. Team development models and the Myers-Briggs personality type analysis were utilized. These analyses helped the HP team learn how to benefit from diversity instead of working against it.

The Tools :

Aside from extensive market research, the HP34401A project primarily used three key tools in the course of its development. These tools were: Quality Function Deployment (QFD), Activity Based Costing (ABC), and Design for Manufacture and Assembly (DFMA).

Results Delivered by Concurrent Engineering :

Did concurrent engineering deliver its promises to the HP 34401A project? The following table 5-1 contains an abridged list of the promises of CE. Along with the comparative data from previous HP products.

Table 2-2 : Comparative data on HP products before and after applying CE.

CE Metric	HP 34401A (%)	Previous Generations (%)	Previous Similar Product (%)
Material \$	80	100	200
Nonmaterial \$	55	100	250
Assembly time	37	100	210
Average repair time	33	100	400
No. of mechanical parts	30	100	190
No. of fasteners	31	100	172
No. of fastener types	8	100	85
No. of connects, disconnects, adjustments	36	100	120
Final assembly part count	40	100	153
Total parts	68	100	190
Total part #'s	77	100	150
No. of suppliers	70	100	N/A
Inventory days	4	100	100
Throughput	100	100	100
1st year engineering changes	0	100	58

Source : Shina, S. "Successful Implementation of Concurrent Engineering Products and Processes," Van Nostrand Reinhold, New York, 1994, p.63.

Summary :

According to Williams, one of the early keys to the success of the HP 34410A was the high level of support received from the entire management chain. They gave the team the freedom and ability to analyze the total system in order to find where true costs were originating, and they also gave the team the necessary infrastructure to form a cross-functional collocated team. There was an overall project manager assigned up front. The team was given a basic product development charter, informed of general boundary conditions, and then afforded the freedom to execute.

Also, the success was due in large part to three additional elements:

- 1) Extensive use of market research.

- 2) Top-down approach (start with cost and work down).
- 3) Cross-functional, collocated team effort.

In conclusion, Williams said that they found that, if genuinely done, CE is just plain hard work.

2.5.2 Chipcom Corporation

Chipcom is a small company, founded in 1983 to design, manufacture, and market fault-tolerant, intelligent switching hubs for the computer industry. It has a culture that is team focused. The Project Management Team (PMT), in which representatives from each functional group work to bring a product from concept to market, is an example of the team approach said John McNamara of Chipcom.

Chipcom has a very positive view of itself, with continuous, health growth year after year. Top industry analysts viewed the company as a winner, with a strong product line and presence in the market. The company had gone public in 1991 and then followed up with an alliance with IBM in 1992. Considering Chipcom's accomplishments, the company could have concluded that there was no reason to change. However, there were several issues that forced many in the company to reevaluate the corporation's performance and to conclude that the things Chipcom did to achieve its current success would not necessarily ensure future success.

First, there were external factors that Chipcom would have to respond to, but over which they had little direct control. Product life cycles declined, as technology advanced at a fast pace, allowing the addition of new features to enhanced product functionality. In contrast to this, customer sophistication and experience grew, resulting in a greater demand for product variety and very competitive pricing. Customers were pushing vendors to make their products interoperable. This means that customers have less reliance on any single vendor and that corporations such as Chipcom would have a greater need for the latest technology when the customer needs it.

Customers need quick delivery of product, since they are also trying to meet the immediate demands of their customers.

Lastly, there were internal factors over which Chipcom had greater control to change. Chipcom's market position is related directly to customers' and resellers' perception, not on its actual market standing. The company was still working with methods that worked for the smaller company, and rapid growth had put strains on the internal processes. Most importantly, Chipcom was competing with companies that had more resources, market share, and people and was intent on overtaking those competitors.

According to McNamara, this is how Chipcom decided to implement CE as a method of solving the problems presented by both internal and external factors. Also, the Chipcom culture is compatible with the changes that CE proposed.

The Project Management Team (PMT):

The task team or PMT consisted of representatives from Marketing, Development Engineering, Product Engineering, Advanced Manufacturing Engineering, Technical Support and key suppliers. The team is a group of strong professionals who own the responsibility of delivering a new product to the market. The PMT members are peers, with no one members having decision-making authority over the others. This feature of the team can cause conflicts, so a respect for each members is important, as is the willingness to listen to each member's opinions. A unanimous vote will allow the PMT to move forward, but objections will stop the process. In that event, the members with the objection will take action to resolve the conflict so that the team can work back towards establishing a consensus. Those issues unresolved will be escalated to the PMT manager.

The PMTs have a room in the company set aside just for team meetings. The room is bright and is equipped with a conference phone and a white board. It is comfortable and conducive to holding discussions without interruption. Meetings times for each approved PMT are published, so everyone knows when a

decisions. Most importantly, the PMT manager would act as a tiebreaker, in those instances when the PMT cannot resolve a problem internally.

Tools:

According to McNamara, CAD (Computer-Aided Design), CAE (Computer-Aided Engineering), and CAM (Computer-Aided Manufacturing) tools can play a major role in implementing CE, but must not be its focus. The organization should concentrate on the interdependencies of each group and how they relate to the new product process. Tools assist Engineering in doing it right the first time and in shifting the task from a serial to a parallel process.

The Electronic Data Automation (EDA) group, which supports the CAD and CAE tools, has assisted Manufacturing in developing methods to transfer CAD data directly to automated placement equipment at the contract assembly house, resulting in the ability to reduce errors in programming and to accelerate the new product manufacturing ramp-up.

A technique like QFD is also used to incorporate the customer's voice. The foundation of this tool is designing the product to reflect customers' desires and tastes so that Marketing, Design, Manufacturing, Technical Support, and Sales work together to formulate a product designed by customer response.

Software application tools, such as standard software packages, are ways of presenting information so that effort is not spent on converting information from one form to another. MIS can play a large role in establishing software standards and evaluating software packages. Common software and formats means that everyone can access information. Graphics packages, word processors, and project planning software are all essential for the smooth operation of the PMT.

Training :

Training is a major focus within CE at Chipcom and would include project management skills, QFD training, team building, leadership training, performance appraisal skills, and technology training.

Measurements :

A concern of the task team was to show that CE was improving the new product process and not simply replacing one process with another, said McNamara. A second team was set up to address this issue and established four key metric categories. These are :

1) Customer Satisfaction

The goal of any business is to satisfy the customer. The team viewed this as the primary metric category. Market share gains, warranty claims, customer complaints, on-time delivery, and percent reorder were as the specific measurement that would be set up.

2) People

The second important metric category involves people and their performance. Several metrics that the team identified to track people's performances were percentage of on-time performance reviews, turnover rate, and percentage of work time devoted to training.

3) Product Delivery

Improving the product delivery cycle meant improving margins, improved return on investment, reduced run-rate development costs, less risk in forecasting the needs of the customer, and the ability to utilize the latest process and product technologies. Several metrics that the team identified for this category were the Engineering Change Order (ECO) generated after a product was introduced, time-to-market as measured from phase 1 to production, design stability based on bill of materials changes, and the number of part numbers.

4) Financial Health

A primary goal of the team was to show the potential return on investment for CE. Several metrics that the team identified for this category were return on gross assets, cash flow, asset turnover, and value added per employee.

Summary :

CE is a process that works for Chipcom because the company identified for itself the internal relationship that allow it to produce the best products for its customers at the right time. Chipcom then practised those relationships, to turn them into "the way the company does business" and not just another program. Chipcom is over two years into concurrent engineering. The changes that Chipcom has made are working and have helped to focus the company on clearly defining each product before beginning the design.

2.5.3 Sun Microsystems Inc.

Sun Microsystems Computer Corporation is the world's leading supplier of open client-server computing solutions. The company was founded in 1982 and has grown into a multi-billion dollar corporation in 10 years.

Despite difficult economic times, Sun Microsystems has continued along a successful path. Revenues and sales have grown steadily. Why is Sun Microsystems doing so well?

CE Application in the New Product Development :

There are several major reasons why Sun Microsystems is doing so well. We deliver the following, says Christopher Natale, of Sun Microsystems :

- High-quality products that are competitively priced.
- Products that utilize leading technologies.
- New products to the marketplace in a timely fashion.

The application of concurrent engineering principles helps us to achieve these critical success factors, said Natale.

Sun Microsystems New Product Introduction (NPI) Model :

The proper organizational model must be established to support a successful CE effort. CE requires an abundance of cross-functional activity by all NPI team members. Natale stressed that upper management must be fully committed to supporting this philosophy and culture. Figure 2-7 next page illustrates the communication flow and interactions of various organizations within the NPI process at Sun Microsystems [Shina_3, p94].

Figure 2-7: NPI Program Information Flow at Sun Microsystems.

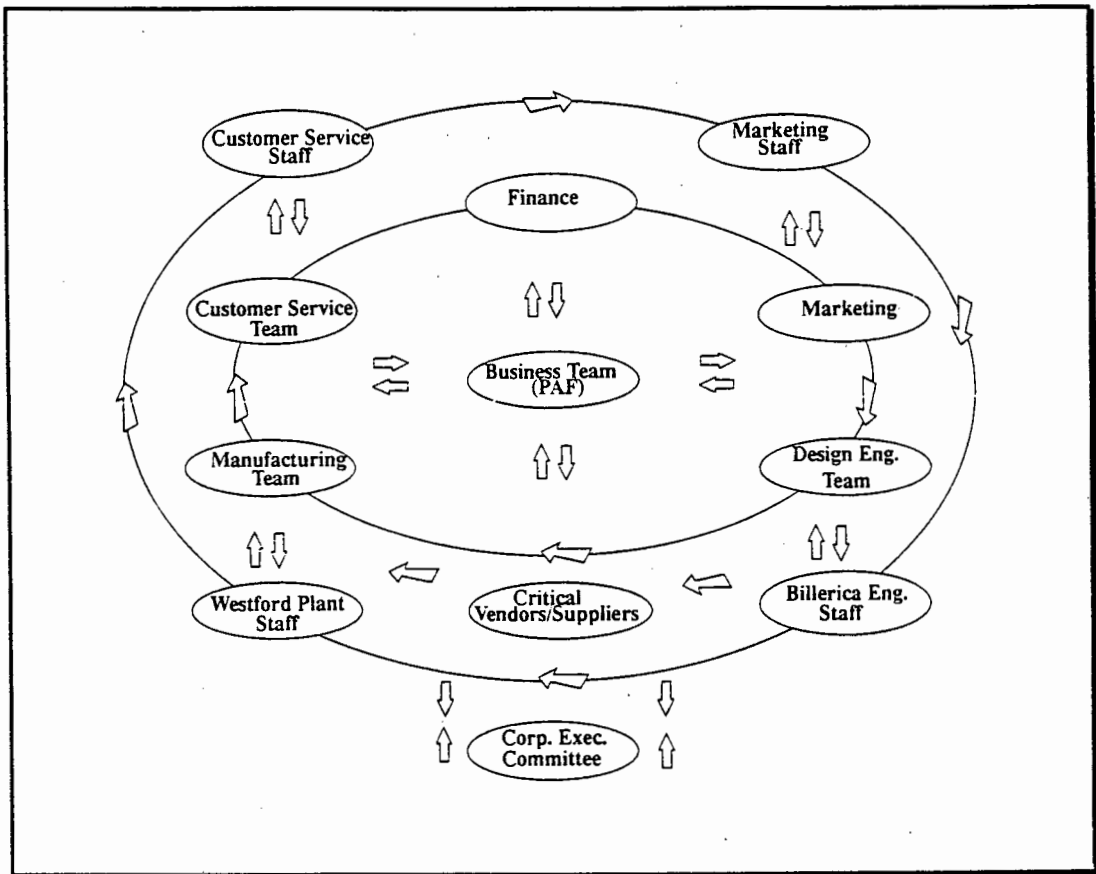

Sun Microsystems Business Team and Product Team Model :

The communication interaction that is shown above in Figure 2-7 is achieved through the use of a business team and several functional teams.

The business team is established in the conceptual stages of a new product and prior to the "official product approval." This business team is comprised of the following people:

- Team leader, who is usually a director or vice president from Design or Marketing.
- Design manager.
- Manufacturing program manager.
- Customer service manager.
- Marketing manager.

The role of this business team is to continue with the investigation of the proposed product and to create a formal product plan called a Product Approval Form (PAF), which is submitted to an executive-level Product Strategy Committee.

The PAF is a very detailed document that consists of:

- Executive overview.
- Marketing plan.
- Product overview.
- Competitive overview.
- Product development overview.
- Operations overview.
- Customer service overview.
- Business plan and strategic assessment.

The PAF defines why the product should be developed and how it will be marketed, designed, and manufactured. This document will also detail product development costs, the target first customer ship date, and the approximate sale price. Once the Product Strategy Committee approves the new product, an NPI team is formed.

Role of the NPI Team Members in the CE Capacity :

In the product team environment, the team members have various roles. This section outlines the team member responsibilities in the new product development process.

- Role of the NPI program manager :
This person has overall responsibility for coordinating all manufacturing activities in the new product development cycle. This individual also participates on the cross-functional business team that defines product and schedule.
- Role of the marketing representative :
This person determines the marketing strategy for the new product, and defines the market for which the product should be targeted. He/she also performs a market trend analysis and studies technology trends.
- Role of the manufacturing engineer :
His/her primary function in the new product development process is to ensure that new product meets high-volume manufacturing requirements. Products

must be easy to assemble. He/she also defines and establishes the optimum manufacturing process.

- Role of the design engineer :

The design engineer works closely with mechanical and manufacturing engineering to develop a product that meets the product requirements as defined in the product approval package. Design engineers interface closely with industrial design and environmental engineering to ensure that the product meets its other critical requirements.

- Role of the customer service representative :

The customer service engineer works to ensure that enclosures are designed to be customer maintainable and to insure that there are on-board and stand-alone tests capable of isolating failures. He/she also provides information about new technologies that could impact service delivery.

- Role of the test engineer :

The test engineer develops and institutes the test processes for the new products. This person interfaces with design engineering to ensure product testability.

Competitive Analysis :

One of the aspects of CE that Sun applies is competitive analysis. The Advanced Manufacturing Technologies group purchases various "best-in-class" competitors' products. A competitive analysis team is formed of representative from the following groups:

- Customer Service.
- Supplier Engineering.
- Test Engineering.
- Commodity Management.
- Manufacturing Engineering.
- Product Marketing.

The competitive analysis team performs a thorough product analysis and disassembly of these products. The analysis includes an in-depth study in the following areas:

- Cost

- Service
- Test
- Delivery
- Time-to-market
- Warranty
- Quality
- Design for Manufacturability

The team representative compare their products to their competitors' products. The favorable and unfavorable product attributes are examined. This information is then combined, which details information down to the component level, is distributed throughout various organizations in the company. The report contains :

- An executive summary
- Conclusions that summarize the bottom line results
- Comments on various favorable design characteristics
- Recommendations to be considered on their next new product

2.5.4 Conclusions from the Literature Review

The literature review carried out has fulfilled its objective by gaining an insight on some overseas companies encounter with CE. The findings of the literature review are used to derive guidelines for managers who wish embark on a CE program.

2.6 Concurrent Engineering as Management's New Competitive Weapon

In the worldwide competitive arena, companies have to react quickly with new products in order to respond to customer trends, technological advances, and competitors' product. In addition, they need new products to continue to grow by opening new markets, creating customer demand, and increasing their market share. The key to success in these competitive strategies is the company's ability to create new products quickly by doing development, manufacturing, and delivering customer satisfaction "right the first time."

When design time (time to market) is short, a company can support a smaller volume and lifetime for each product and introduce a larger number of different products in the marketplace. This competitive advantage allows for a successful sales strategy and therefore larger overall profit. With so many products, the market can be partitioned appropriately, with different products focused on different segments of the market. In addition, since the majority of the profits occur in the early part of the cycle of successful products, the products are turned over much faster, allowing them to be retired at close to the optimum profitability.

It is well documented that new products are the main revenue generators for electronics companies: their sales replace old products sales before the old products mature and their sales and profits decrease. And also, these new products are more profitable because they are more responsive to customer demands and they take advantage of newer and lower-cost technological changes in design and manufacturing.

Growing electronics companies are aware of the leverage of new products, and spend a substantial part (more than 25%) of their revenues on developing new products (R&D) as compared to more established companies, which spend less (5-10%) [Shina_1, p3]. Concurrent engineering can play a significant part in the effective application of this investment: The techniques of concurrent engineering focus on the product concepts in order to meet market and customer expectations, and reduce the time and iterations of new product development by producing prototypes that are made to specifications, and meet the company's manufacturing requirements. There is clearly no time to correct design mistakes and errors, and to re-engineer a product for lower cost or higher quality. With the help of CE, new products will meet customers' needs in a timely fashion, and with low cost and high quality.

With the growth of multinational corporations, competition in the world marketplace is relentless. Only those who can get the highest quality, price competitive product to market in the least time are going to be winners. Even small companies must understand this and be ready to participate in global markets to be successful.

Companies with traditional new product policies are already finding themselves losing market share, profits, and even their independence, as they have to merge with, or are taken over by, others, or, worse still, are completely disappearing.

3. RESEARCH METHOD

The objectives of the research were fulfilled by gathering specific information by the following methods :

- *Literature Review* : Desk Research using ProQuest ABI / Inform and Jagger Reference CD-ROM available at the library of the University of Cape Town on overseas companies that are using CE.
- *Industrial Survey*: The survey was carried out among electronics manufacturing companies in South Africa. Primary survey questionnaires were sent to respondents followed by secondary questionnaires. Interviews were conducted to obtain further clarification and/or information from respondents.

It is suspected that the application of CE in South Africa is relatively new and thus, still in its infancy. Therefore, in the event that the information gathered in the surveys is quantitatively insufficient to test the hypothesis of this research, the method of triangulation will be used [Leedy, p143].

The names and contact numbers of the South African electronics manufacturing companies were obtained from the S.A. Electronics Buyer's Guide (EBG) 1994 directory of manufacturers, which is a guide published and updated every year by *Technews Publishing*.

From the list of manufacturing companies, a total of only 32 companies were found to be eligible to participate in the survey under the following criteria :

- 1) The company must be an electronics manufacturing company.
- 2) The company must employ 50 or more employees. Most thinly staffed companies are probably applying CE at least in spirit because the people doing design engineering are often responsible for manufacturing development, or they, at least, know what it takes to get parts produced. Where CE is being rediscovered, is primarily in larger firms with strict

division of responsibility and psychological walls between design and manufacturing.

3) The company must be developing new products.

In order to ensure that the right person answered the primary questionnaire, the companies were first contacted by phone and either the program, project or engineering manager of the company spoken to. The reason for choosing either of these three managers was because they are the people who would be directly involved in a CE program and they are the ones who would most probably initiate such a program. The manager was briefed on the reason for the call. In all cases, they were prepared to participate in the survey. The questionnaire was then faxed to that person and he/she was asked to fax it back. In order to make the best use of technology, the facsimile method was used because it is quicker and more reliable than the mailing method and also it is much easier for someone to reply by fax. Thus, greater response to the survey was ensured.

One week was given to the respondents to fax back the completed questionnaire. If a respondent did not reply after the one week period, he/she was contacted by phone and was kindly reminded to do so. If after the reminder, the respondent did not reply, that particular questionnaire was regarded as an abstention.

As the respondents were faxing back the completed primary questionnaire, the questionnaires were checked for companies that have implemented or were busy implementing a CE program. Companies that have implemented CE fully or partially were then sent the secondary questionnaire which concentrated on their experiences with their CE program.

Where further clarification or information was required from the relevant manager in the company, interviews were conducted.

3.1 The Scope and Limitations of the Surveys

The scope of the surveys was limited to the following :

- The surveys were restricted to the South African electronics manufacturing companies only.
- Face-to-face interviews were conducted with companies based in Cape Town and telephonic interviews were conducted with companies outside Cape Town owing to practical and cost considerations.
- Access to certain information in certain companies was hampered due to the level of confidentiality surrounding strategic plans.
- Information gathered about the CE concept was confined to data available locally.

3.2 The Questionnaire Construction

Two questionnaires were constructed for the industrial survey : a primary and a secondary questionnaire. Interviews were also conducted with local CE practitioners but no formal questionnaires were used. Instead the interviewees were asked to comment on their experience on CE and expand on some of their responses given in the secondary questionnaire.

It was considered that long questionnaires do not catch the attention of the majority of people and as such, the response is poor. They want concise and direct questions that will allow them to give equally precise answers. Bearing this in mind, the two questionnaires were designed accordingly.

3.2.1 Primary Questionnaire Construction

The primary questionnaire was intended to test the level of awareness of the CE concept in the South African electronics industry, and also, to identify which companies have experimented with CE. The questionnaire started with a definition of CE followed by a listing of the different names under which the concept is also known. (A copy of the primary questionnaire can be found in Appendix I)

The first and most important question in the questionnaire was set to determine whether the respondent knew what CE was about. If the response was positive, then he/she was asked about the source and depth of that knowledge and finally if the CE concept was ever used in his/her company. The responses received allowed the researcher to determine the level of awareness of the CE concept among the managers and also to identify the companies that have experimented or are busy experimenting with the CE concept.

The rest of the questionnaire was set out to gain an insight of what the respondents think about the CE concept without going into too much detail. Questions such as to whether the respondents would ever consider implementing CE in their companies and if so, how much resistance would they encounter from their various functional departments were among those that provided the most pertinent insights.

3.2.2 Secondary Questionnaire Construction

The objective of the secondary questionnaire was to determine the extent to which the CE program had been applied to the local electronics companies and to what extent the implementation was successful or unsuccessful. The ratio of companies which implemented CE successfully versus unsuccessfully gave a good indication of whether electronics companies in South Africa can successfully apply CE.

The questions were structured in such a way that respondents were asked to share their experience / expertise and advise on their encounter with CE. Factors that have contributed to either the success or failure of their CE encounter could be determined. This feedback complemented the findings of the literature review and helped the researcher in achieving the third and last objective of this research, which was, to derive practical guidelines for managers of the local electronics manufacturing companies who wish to embark on a CE program. (A copy of the secondary questionnaire can be found in Appendix II).

3.2.3 Interviews with Concurrent Engineering Practitioners

No formal questionnaire was constructed for the interviews conducted with the CE practitioners. The following proponents of CE were interviewed :

1. Mr. Bob Evans, project manager of Telecommunication Division at Plessey Tellumat SA, Cape Town.
2. Dr. Steve Minnaar, CE coordinator at Plessey Tellumat SA, Cape Town.
3. Mr. X (the interviewee has requested that his name be kept anonymous), design engineer at Kentron (Pty) Ltd., Pretoria.
4. Mr. Fadl Hendricks, project development manager at AECI Limited. (AECI is not an electronics company but this interview was conducted to allow him to share his views and advise on the CE implementation in a South African context).

4. FINDINGS OF THE INDUSTRIAL SURVEYS

The findings of the industrial surveys are those resulting from the primary and secondary questionnaires sent to the respondents and the interviews conducted among the CE practitioners.

4.1 Findings of the Primary Questionnaire

The responses received from the primary questionnaire are summarized in a table form in Appendix III. The results are discussed under the following appropriate sub-headings.

4.1.1 Level of Awareness of the CE Concept

From the thirty-two South African electronics companies surveyed, it was found that the level of awareness of the CE concept among their engineering managers is 68.8%, i.e. 22 managers knew about the concept of CE.

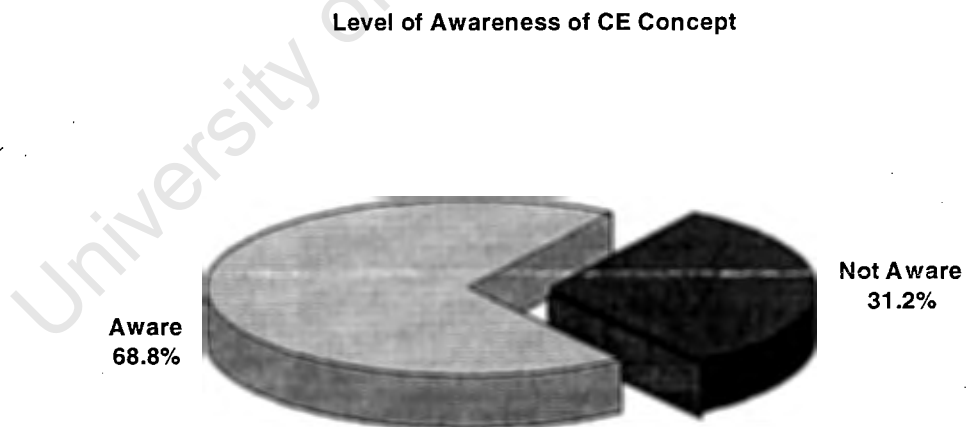

Figure 4-1 : Proportion of managers being either aware or unaware of the CE concept.

Out of the twenty-two managers who knew the concept of CE, twelve of them, i.e. 54.5%, first came across the concept through reading materials, six, i.e. 27.3%, had heard of the concept through colleagues, and the remaining four, i.e. 18.2%, had been lectured on the concept in either management courses or seminars. On average, these managers have known the CE concept for about six years - the longest time being twenty-nine years (not under the name concurrent engineering) and the shortest being just one year. Though, they knew the concept, their depth of knowledge varied markedly. It was found that only five of the managers, i.e. 22.7%, claimed to be expert in the CE field. Eight, i.e. 36.4%, rated their knowledge of CE as good whereas the remaining nine managers, i.e. 40.9%, said their knowledge of CE is poor.

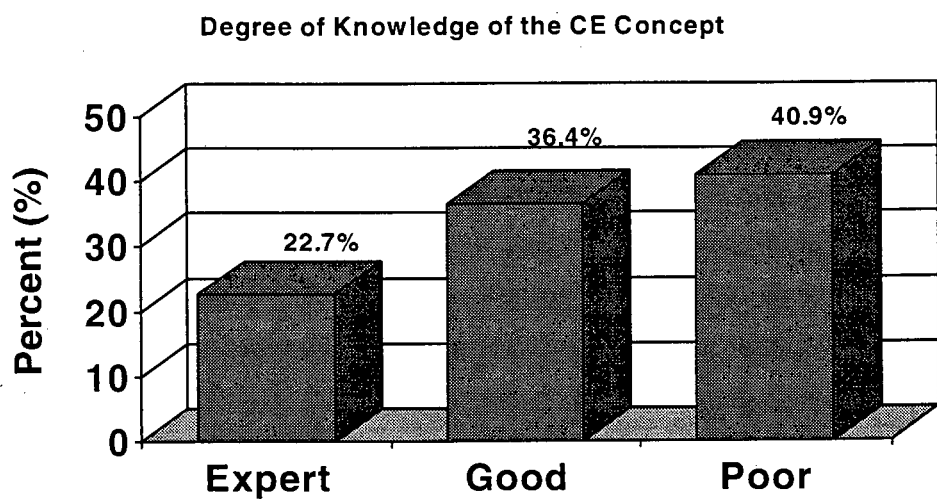

Figure 4-2 : Degree of knowledge of the CE concept claimed by managers.

4.1.2 Degree of Concurrent Engineering Application

One of the specific objectives of the primary survey was to determine which of the local electronics manufacturing companies had experimented with CE before, and which are currently implementing a CE program. The survey revealed the following:-

Out of the thirty-two companies surveyed, the following results are obtained :

- Number of companies that have never experimented with CE = 22 (i.e. 68.7%)
- Number of companies that have partially and informally applied CE principles in some of their projects = 7 (i.e. 21.9%). These companies are :-
 - ① Irengo (Pty) Ltd.
 - ② Denel / Houwteq (Pty) Ltd.
 - ③ Delstar (Pty) Ltd.
 - ④ Quad Triangle (Pty) Ltd.
 - ⑤ Spescom (Pty) Ltd.
 - ⑥ Kentron (Pty) Ltd.
 - ⑦ Expert Explosives (Pty) Ltd.
- Number of companies that are currently using a proper and complete CE program in developing their new products = 3 (i.e. 9.4%). These companies are :-
 - ① Plessey Tellumat SA (Pty) Ltd.
 - ② Conlog (Pty) Ltd.
 - ③ Tek Logic (Pty) Ltd.

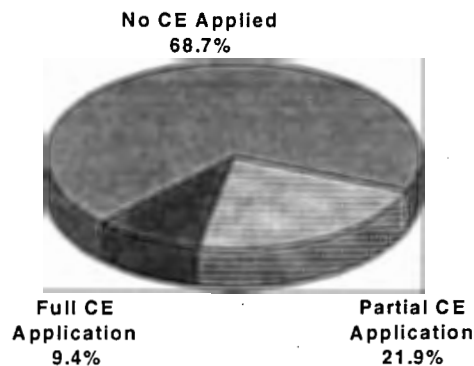

Figure 4-3 : Percentage of South African electronics companies which have and have not experimented with CE

Out of the twenty-two companies where the concept of CE has never been used before, the manager in eighteen of these companies (i.e. 81.8%) said that they would consider using CE as an approach to gain competitiveness in the future. The remaining four managers did not think that their companies would ever consider implementing CE for reasons, such as, they do not have competition in the local market and they do not think that they will ever sell internationally. They produce specialised designs for a small customer base.

4.1.3 Future Plans to Implement Concurrent Engineering and Resistance Levels

The managers of the eighteen companies who said that they would consider implementing CE in the future, were also asked how soon they would start planning such an implementation. Their responses were as follows :

- Nine of them, i.e. 50%, said they would start planning in six months' time.
- Five of them, i.e. 27.8%, said they would do so in a year's time.
- The remaining four managers, i.e. 22.2%, said that such planning would only start in approximately two years from now.

Since top management's commitment to CE is vital for the successful implementation of CE, these eighteen managers were requested to indicate the amount of resistance to change to CE they were likely to encounter from top management.

Based on their top management's past record in handling changes, these eighteen engineering managers' response to the question were the following:

- Five of them (i.e. 27.8%) were confident that they will not encounter any resistance from top management.
- Twelve of the remaining managers (i.e. 66.7%) felt that they will have to deal with some resistance, though not too significant.
- Only one of the managers (i.e. 5.5%) believed that he will encounter major resistance.

CE necessitates a multi-disciplinary product development team consisting of design, process and manufacturing engineers. It also involves persons from marketing, purchasing, and finance departments who are committed to achieving common objectives by working well together; sharing resources and information. To determine which departments in the companies will be least and most resistant to participation in a CE team, the managers of the eighteen companies were requested to indicate that in the questionnaire. Their responses are tabulated below.

Table 4-1 : Expected resistance level in different departments of the companies investigated

Department	R&D	Manufacturing	Marketing
Least Resistant	16.7%	27.8%	55.5%
Most Resistant	72.2%	27.8%	0.0%

The general trend shows that the marketing department in most of the eighteen companies will be least resistant to a CE program whereas, R&D will

be the most resistant. Resistance from finance and purchasing departments were insignificant and therefore not included in the table.

CE also requires a good communication infrastructure for the sharing of product data and information. To determine whether the eighteen companies which will be implementing CE in the near future are well equipped to do so, they were requested to describe the capability of their computer network system at present. The results are the following:

- Twelve of the eighteen companies (i.e. 66.7%) have a network system with limited capabilities.
- The remaining six companies (i.e. 33.3%) have a flexible network system with the possibility of expanding it as needs grow.

Finally, to end the primary questionnaire, the respondents were asked to express their opinion as to whether they think CE can be successfully implemented in our local electronics companies. The response was that twenty-eight of the thirty-two respondents (i.e. 87.5%) think that CE can be applied successfully as opposed to only 4 respondents (i.e. 12.5%) who think CE will not work because South African managers are not ready for the style of management that CE requires.

4.2 Findings of the Secondary Questionnaire

As mentioned earlier in section 4.1.2, there are seven companies that have partially applied CE principles in some of their projects and only three companies, namely, Plessey Tellumat, Conlog, and Tek Logic, which have implemented a complete CE program. The secondary questionnaires were only sent to these three companies whereas telephonic discussions were held with the respondents of the seven companies which have applied CE principles partially. The findings from the telephonic interviews have been included under the derived guidelines section which is discussed later.

The findings from the three companies to which secondary questionnaires were sent are summarized below.

□ **Overview of the companies**

Plessey Tellumat SA (Pty) Ltd.

Plessey Tellumat SA is based in Cape Town and it specializes in the manufacture of radio telephone systems, prepayment electricity meters, traffic controllers, electronic distance measuring systems (tellurometer), mining electronic products, and telecommunication products like telephone and Private Automatic Branch Exchange (PABX) switching systems. The respondent to the questionnaire was Dr. Steve Minnaar, CE Coordinator at Plessey Tellumat. He recently completed a Ph.D. at the University of Stellenbosch based on his extensive work in developing a strategy and support system for CE at Plessey.

Conlog (Pty) Ltd.

Conlog (Pty) Ltd. is a Durban-based company. The company manufactures industrial electronic instrumentation equipment and telemetry systems. The respondent to the questionnaire was Mr. David Celine, the engineering director.

Tek Logic (Pty) Ltd.

Tek Logic (Pty) Ltd. is a member of the Altech Group and it is based in Midrand, Johannesburg. It manufactures telecontrol and telemetry systems, monitoring systems, and data logging equipment. The respondent was the engineering director, Mr. Johan Kleynhans.

□ Factors that drove the companies to take on CE

Plessey Tellumat first became involved with CE in late 1991 when the company was involved in the Rural Telephone project. The factors that drove Plessey to take on CE were the following :

- The desire to reduce the time taken to develop and manufacture new products.
- The necessity to reduce costs associated with (expensive) changes late in the project.
- The need to design for manufacture and reduce engineering redesigns.
- The desire to increase the company's competitiveness in the market-place by improving quality of products.
- CE sounded advantageous - "tried it with its few principles at no cost" - (the "could-not-lose-anything-if-it-fails" attitude).

Conlog became involved with CE in the late 1993's. Factors that drove Conlog to take on CE were :

- The desire to reduce the time-to-market of its new products.
- To improve quality of design thereby increasing its competitiveness in the marketplace.

Tek Logic became involved with CE in mid 1993 and the main factors that drove them to take on CE were:

- The need to shorten lead times on development prototypes.
- The need to compete in commercial markets.

□ ***Top management commitment to the CE approach***

At Plessey, top management initially agreed, in principle, with the idea of a CE approach but they were not proactive and not financially committed to it. However, market pressure to produce new products later forced top management to be totally committed to CE.

At Conlog, from the very start, top management was in favor of a CE approach. Others who were sceptical about the concept were convinced when they were presented with the benefits gained from the pilot CE project.

The whole idea of experimenting with CE at Tek Logic originated from a small group of engineers from the design and manufacturing departments. Initially, top management was not against it; but neither did it show any sign of being fully committed to it. It was only after their first pilot CE project started to show some signs of success that top management became really involved and fully supported the CE idea.

□ ***Their first steps in implementing the CE program and "word of advice"***

The first steps in implementing CE at Plessey were :

- To get commitment to CE from all those who were involved.
- To identify a "champion" from each discipline who was involved in a project to make up the CE team.

For companies which are now planning their first steps in CE, Dr. Minnaar's advice is :

- Have a proper strategic planning and plan the training of the team players and staff in CE theory and practice.
- Develop and set up suitable computer based systems for sharing and access of information. Effective communication within the team on a daily basis must be ensured.

At Conlog, their first steps in implementing CE were :

- To train the team members on the theoretical aspect of the CE concept.
- To perform team building exercises.

Celine's advice to companies wishing to adopt CE is :

- To concentrate firstly on the soft issues and then on the enabling technology. According to Celine, too often the soft issues are taken for granted and management expects employees to adapt to changes immediately.

At Tek Logic, their first steps in implementing the CE program were :

- To identify a core CE team.
- To plan for the first meeting.

Kleynhans' advice are :

- To pick individuals who will make CE happen. Do not waste time trying to convince everybody. It is very easy to get stuck in the loop of walking around the problem, studying it to depth, and never really getting started. Start it, and the rest will follow.
- Select a champion and make CE part of his/her job description.
- The team members must be open to changing the way they are doing their business. Merely telling people to work together as a team and to plan tasks up front is just not enough. Make sure questions like who controls funding, what is really different about the process, what are the roles and responsibilities of the members, etc. are answered before embarking into CE.

□ *Criteria used to select Members of the CE Team and the Team Composition*

For Plessey :

The experience of the members in their fields and to some extent the "team player compatibility" of the person were the criteria used to select the CE team members

Members of the team came from R&D (design), manufacturing, drawing office, product engineering, quality assurance, and, sometimes, purchasing department.

Depending on the complexity of a product under development, Minnaar is of the opinion that the number of members in the CE team should be around five for a

simple product, fourteen for a fairly complex product, and as much as needed for a very complex product.

The levels of authority and responsibility given to the team members are still limited at Plessey. Team members still report to their respective functional line managers but every effort is being made to give them the necessary authority to complete each of their tasks

For Conlog :

The technical skills of the members in their respective fields, and their ability to work in a team spirit were the criteria used to select the CE team members. Celine argues that not everybody can work in a team. Choosing someone who is very skillful but not cooperative in a team might be detrimental to the whole CE process. Therefore he feels that extra care should be taken when selecting team members.

The team members came from the R&D, manufacturing, sales and marketing departments, and a representative from the customer was also included.

According to Celine, the number of members in a team should range from three for a simple product to eight members for a very complex product.

The team members had the authority to make all design decisions unless a drastic decision needed to be taken in which case the line managers were first consulted.

For Tek Logic :

In selecting the members for the CE team(s), Tek Logic identified a “champion” from each discipline.

Team members came from R&D (design), manufacturing, drawing office, software division, finance, and purchasing departments.

According to Kleynhans, when designing a simple product, the CE team should consist of around five members. For fairly complex to very complex product, the team should be made up to ten members. Kleynhans warns that the CE team should not be larger than ten members because, then, the number of communication paths increases and so does the complexity.

Team members have the authority and responsibility to complete the project but within the guidelines / delegations set out in the meetings.

□ ***CE Team Training & Frequency of Meetings***

When Plessey initially experimented with CE, little training was given to the team members to prepare them to work in a team spirit but now, team building exercises are becoming very common. The frequency at which the team meets over a weekly period has been between one and three times for a one hour period. Dr. Minnaar, however, thinks that they should not restrict themselves to a certain number of meetings. It should depend on the complexity of the project, and the team should meet as often as need be..

At Conlog, members of the CE team perform team building exercises on a regular basis. Most of the time, the team held meetings once every week but Celine said that this was not the rule. If there was a need for more frequent meetings, then the team would meet more frequently.

At Tek Logic, each new member of the CE team was briefed on the theoretical aspects of CE. The team held meetings as often as there was need for. There was no prescribed number of meetings.

□ ***Communication Infrastructure & Product Management Software***

Plessey Tellumat has a flexible computer network system with the possibility of expanding to respond to greater needs. Plessey has its own tailor-made product information management software, called ENMAN (Engineering Management System) which allows members of the project team(s) to share product information.

Conlog is currently using a software package, called Lotus Notes, which has a lot of the capabilities required in a CE environment. But the package has some limitations when it comes to sharing engineering drawings. Celine said that they are looking into tailor-making a software module to overcome the limitations of Lotus Notes.

According to Kleynhans, the minimum communication technology needed for CE is a network and a way to send messages to others, i.e. an e-mail system. There are, today, several groupware software packages that can do the job. Kleynhans said that when it comes to sharing data / design drawings across the networks, it is important to have the proper software tools to do the job. Tek Logic are currently looking into tailor-making their software to provide them with the necessary tools.

□ ***Tools used to meet customer requirements***

At Plessey, customer's expectations are determined and converted to established, documented customer requirements but not by means of a proper scientific method like Quality Function Deployment (QFD). At the moment, these requirements are being met by constantly communicating with customers, at all levels, by a wide spectrum of company staff. Plessey is currently looking into the possibility of using QFD.

According to Celine, customer expectations at Conlog are determined but not by using Quality Function Deployment (QFD) as a means of integrating the customer requirements into the product development. They are currently meeting customers requirements by keeping the customer aware of every change happening in the product development. Celine acknowledged that the method they are using is not scientific and that, in due course, they will have to adopt something like QFD.

At Tek Logic, customers' expectations are determined and their requirements are fulfilled by meeting the system specifications of the products. They are not using any formal technique like QFD in their process.

□ **The CE Pilot Project**

When Plessey first experimented with CE, they chose a pilot project which had a tight time and cost constraint. The aim of the pilot CE project was to prove that CE could achieve its goals within tight time and resource constraints. The pilot project was also a short one, so that the results and lessons of the CE effort could become visible quickly and be applied to other pilot projects as well. According to Dr. Minnaar, the overall success of that project made it easier to sell the CE idea to top management and soon commitment to the concept was duly gained. Some of the improvements achieved in the pilot project are listed below.

- Development time was reduced by almost 40%.
- Two iterations less per phase were achieved.
- Better team spirit across the company divisions was achieved.
- Fewer manufacturing problems were experienced.

At Conlog, they chose a neatly defined project that could stand on its own (i.e. not related to any other project) as the pilot project. The objectives, the time scale, and the allocated budget were clearly stated. Celine pointed out that without applying the CE principles, the project would not have been able to be completed in time and still fall within the allocated budget. Celine added that he has seen many companies making the common mistake of attempting CE in a single department or function. He argued that due to its very nature of being a cross-disciplinary approach, CE cannot be applied to a single function. CE should be applied horizontally across the organization, not vertically within a function

In choosing their first pilot project, Kleynhans said that they picked a project that has known issues and which involves all the desired departments within the company. The term 'known issues' refers to the employment of established technology, meaning there is no need to carry out basic research to develop the product. Kleynhans claimed that they had some problems at the beginning where some functional groups did not want to lose people to the project. But, fortunately, with the backing of top management, this problem was sorted out

□ **Measuring CE**

The key measurements that Plessey used to determine the success of its CE program were the following :

- Cost of changes made.
- Reduction in number of engineering design changes during production.
- Time to market.

In future projects, Minnaar would like to publish the results for all to see. He wants the CE projects to be visible to the entire company.

At Conlog, the success of its CE program were determined by measuring the following factors :

- Reduction in number of engineering design changes during production.
- Time to market.
- Quality of end product

The key measurements used so far by Tek Logic to determine the success of their CE projects have been the following :

- Reduction in the number of engineering design changes during production.
- Cost of changes made.
- Time to market.
- Quality of end products.

□ **How to Maintain the Momentum of CE once it is established?**

According to Dr. Minnaar, the momentum can be maintained by establishing a CE committee that plans, monitors and constantly improves on the CE implementation. Ongoing support from executive management would certainly help. He further added that technology issues such as groupware, and information systems must be improved to maintain the CE initiatives.

Celine believes that it is important to develop structured project reviews whereby the CE process can be monitored constantly and continuous

improvements can be made to the process. He also thinks that an information system will be the type of technology that will be important for maintaining the momentum of the CE initiatives.

Once CE is implemented, Kleynhans stated that it is very important to maintain the momentum. A way of doing that would be to reward the team through incentives such as promotion, to finance further studies, etc.

□ ***Benchmarking the CE process***

Plessey has not yet benchmarked its CE process with any other company. The reason for this is that CE is still at its infancy stage in South Africa and not many companies or competitors have reached a point where benchmarking their CE processes is possible. But Dr. Minnaar is confident that a time will arrive in South Africa when benchmarking will be possible. The activities that he would like to benchmark would be the cost targets, the number of engineering changes after release, the number of production changes after release, and the market timing.

According to Celine, Conlog is not ready to benchmark its process. This is not something that Celine sees as important for the moment. He believes it will still take some times (1-2 years) before benchmarking will be possible in South Africa.

Tek Logic is not benchmarking its CE process but Kleynhans mentioned that he would ideally like to be able to benchmark the process as soon as possible.

□ ***Problems Encountered***

Plessey's first experience with CE has not gone by without encountering any difficulties. Minnaar pointed out some of the problems that they ran into :

- Initially, little (if any) support was obtained from functional managers and top management.
- Team members were also not totally committed to the program - there was some scepticism.

- No proper information technology tools were available and the administrative processes were very slow. They had problems in getting staff to conform to procedures set up for doing documentation - their staff tended to document the old way.

Despite the success of their first pilot project, Celine admits that they came across some difficulties. Some of the problems were :

- A lack of technology to deal with the huge amounts of information that were generated and this information had to be shared in real-time.
- Some reluctance on the part of some of the team members to take decisions. With the traditional way of developing products, these members did not take such decisions.

At Tek Logic, some of the problems they encountered initially were :

- Support from top management was very limited.
- The inability to change to new ways of thinking by some staff and managers delayed some tasks from getting done quickly.

□ ***Advice for managers who wish to embark on a CE program***

From Dr. Minnaar :

- Do not expect too much, too soon. Try, try and try again. Patience is the name of the game.
- Make certain that CE is driven "top-down". First ensure total commitment by top management then by junior staff.
- Educate / train staff on CE concept. Don't expect them to just change their way of doing their job overnight.
- Do not underestimate the human resources needed - you will need more because of the parallel way of operating.
- Use technology to enable teamwork over local area networks (LAN).

From Mr. Celine :

- Beware of underestimating the people issues. Comfort levels are initially reduced when CE is implemented and the people involved should be

reassured that it will be in their best interest and in the interest of the organization to have these changes. He is in favor of implementing special training sessions to prepare employees to deal with the culture shock.

From Mr. Kleynhans :

- Make sure tools purchased are compatible with each other.
- Select a champion who has credibility as the team leader.
- Prepare employees to face the new way of doing their work.

□ ***Was the implementation of CE a success in their companies ?***

Dr. Minnaar : "Certainly", he said. "If properly planned and applied, there is no reason why CE should not work. At Plessey, we have demonstrated that CE can be applied in South Africa."

Mr. Celine : "There is no doubt about the success of CE at Conlog. CE is the way to go."

Mr. Kleynhans : "CE is delivering the goods it promises. So, I would say the implementation is a success."

4.3 Findings from the Interviews

Face-to-face interviews were carried out with Mr. Bob Evans and Dr. Steve Minnaar, both from Plessey Tellumat SA, Cape Town. The findings from these interviews will be discussed in the sub-sections that follow. Telephonic interviews were conducted with Mr. X from Kentron (Pty) Ltd. and Mr. Hendricks Fadl from AECI (Pty) Ltd. Mr. X has requested that his name be kept anonymous. The findings from the telephonic interviews are included in the derived guidelines section.

Interview with Mr. Bob Evans

Mr. Bob Evans, project manager of Telecommunication Division at Plessey Tellumat SA, in Cape Town, spoke about Plessey's CE experiment with their Rural Telephone Project.

Development of Plessey's UHF (Ultra High Frequency) Rural Telephone started on the 5th of October 1991. In an effort to reduce the Development / Manufacturing time cycle, it was decided to run the project on a concurrent engineering basis. The project was consequently given the name "TW3" (Together We Will Win).

Was the CE experiment a success? - "Definitely Yes !", said Bob Evans. "There have been problems but, on balance, there have been more highs than lows and the basic objective of getting a new product to the market place, quickly, is being achieved."

Some of the highs are as follows :

- An Advanced Development Model (ADM) system, made by Manufacturing Division, was demonstrated to, and evaluated by Telkom only 8 working months after starting the project. Projects of similar magnitude took on average 12 working months in the past.

- A totally new Rural Telephone system, with Production tooling, was displayed and demonstrated at the Africon Conference in Swaziland 10 months after starting development.
- Engineering Development Model (EDM) systems were produced by Manufacturing Division only 11 working months after start.
- A happy working relationship was quickly established between Manufacturing and R&D. This after years of difficulties between these divisions.
- It has been possible, as planned, to overlap the Experimental Development Model (XDM), ADM, and EDM phases of development.
- Input from Production received throughout the project, has allowed R&D to design for manufacturing.
- Good communications have been established across divisional boundaries at middle management level.
- After initial scepticism in some quarters, the CE experiment was seen to be working. The result was unprecedented co-operation and optimism that the project would be introduced easily into Manufacturing and to the market.

Unfortunately, Plessey Tellumat was not structured for CE and the Rural Telephone Project ran into a number of problems. "Nevertheless, it runs fairly well" says Bob Evans. A few of the lows are as follows :

- The Purchasing Department was under-resourced for TW3. A potential delay to the project was identified as early as March '92, and repeated requests for an expediter brought no results. Consequent delays in procuring components for XDM and ADM development cost the project 6 weeks.

- QA is understaffed throughout Plessey Tellumat and effective QA in Manufacturing Division was unavailable to TW3. The two R&D people assigned to TW3 had several other project responsibilities and could not be proactive in their QA function.
- A large amount of information was produced and handled across divisions on the CE project. Unfortunately, at that time Plessey's software systems were not controlling and distributing the information in an efficient manner.

Bob Evans also pointed out that an incredible amount of MBWA (Management By Walking Around) had to be done to achieve the CE objectives. But in spite of pressures, it was possible to develop and maintain truly good working relationships between the various functional divisions.

According to Bob Evans , it is important, especially on a CE project with a high weekly spend, to anticipate and avoid delays. Delays cost dearly.

Although executive management knew about TW3 and was no doubt supporting it inside their divisions, Bob Evans is of the opinion that their combined presence was not visible. Their presence would have made a big difference in terms of motivating the team and showing their total commitment to the CE philosophy.

Furthermore, he added that a new measurement system was needed in manufacturing for CE projects. There was considerable Manufacturing activity during XDM, ADM, and EDM phases with no measurable output. This can only contribute adversely to efficiencies and create disincentives.

Since the project TW3, a few other projects have been carried out in a similar CE approach, and mistakes made in the past are helping Plessey cope better with the CE project that they are currently undertaking. Their communications infrastructure have improved a lot and Plessey's custom made software is coping very well.

Bob Evans concluded his interview by saying that it was the success of TW3 project that had made top management buy the CE concept. "CE just makes sense and if you believe in it, it will work for you." he further added.

Interview with Dr. Steve Minnaar

Dr. Steve Minnaar is currently the coordinator of the CE program at Plessey Tellumat SA and he is the one who pioneered the CE concept in the company.

He said that CE was implemented on three pilot projects at Plessey-Tellumat over the past two years. Even though the implementation was limited to some basic principles, he believes the advantages are tangible today. On the RTS project, each design phase had at least two fewer iterations than normal. Process planning and flip-charts for production were 99% correct, even before the pre-production models were built. The product was also introduced to the market at the planned date. According to Minnaar, this is something that is very difficult for the electronics industry to achieve with its long component lead times.

On the project Eddie, Plessey was able to determine after only one month that the planned product cost and functionality were unobtainable and were able to make alternative arrangements. Traditionally these assessments would only have been possible many months later.

On the BTS-micro project, implementing CE resulted in a 45% reduction in engineering services spending during the development phase and 45% reduction in development time for prototype development.

Minnaar further added that Plessey's approach to implementing CE has been cautious, but successful. They initially decided to :

- Identify individuals, specifically from the executive board, to drive the implementation.
- Hand-pick one or two projects to implement CE on.

- While implementing CE on these projects, compile the implementation process in a CE implementation strategy that can serve as a guideline for further implementation.
- If the initial implementation shows potential, start developing a computerized system to support the CE philosophy.

Plessey is now at the stage where they recognize the potential of CE and they are moving from simple strategy and guidelines to developing a tangible support system for CE. A complete Concurrent Engineering Implementation Strategy (CEIS) has been developed and work has started on the actual programming and implementation of the CE Support System (CESS)

According to Steve Minnaar, the real benefits have been the following :

- There has been a great increase in cross-disciplinary consideration and cooperation, resulting in numerous examples of potential production (and other) problems being identified up front and consequently solved.
- The early solving of potential problems resulted in a noticeable decrease in the number of manufacturing teething problems. Many potential purchasing problems were also solved.
- The manufacturing division built the prototype (traditionally done in the R&D Laboratory), helping them to identify potential production problems and get ready for full production.
- In one of the CE projects, there were on average two fewer iterations per project phase. This is the direct result of continuous verification and multi-disciplinary consideration.
- The one CE project, which had to be completed on time, did meet its deadline. This is considered an achievement in the electronics industry.
- Project costing was more accurate and under better control. Because all disciplines were involved from the start, there were more accurate schedules and cost analysis available from the start.
- The great pace of the CE projects and frequent multi-disciplinary team meetings kept all team members on their toes and up to date with the

latest progress of the project. The psychological spin-off was a positive peer pressure not to be identified as the person holding back the team.

- Improved designed-in-quality. Customer requirements were generally better documented and understood and the cross-functional approach resulted in a more robust design, catering for a wide range of potential field problems. The involvement of production from start improved the mechanical design of the product, which at Plessey, an electronic manufacturer, was not always optimal.

Minnaar is of the opinion that an effective implementation of a CE program will only be possible with a computerized support system. The need for such a support system, he added, became evident after implementing the first CE principles. "Very soon it was clear that without a computerized support, CE's potential for enhancing product development is constrained by a ceiling of human capability," he stressed. Steve Minnaar strongly believes that a computerized support system is the only way to achieve the real-time transparency of information to all team members that CE requires. He further added that no paper system would be fast and effective enough to be real-time.

To conclude, Minnaar said that the implementation of CE at Plessey has made people who are expert in their own areas realize how they were ignorant of the other areas, and learn that the collective wisdom on the team far exceeded that of any individual.

4.4 Conclusions from the Industrial Survey

The industrial survey carried out has achieved its objectives in determining the level of awareness of the CE concept among the managers of the electronics companies. It has also made it possible to identify which companies have experimented with CE and to what extent the CE principles were applied.

However, since only three companies out of the sampled population of 32 companies have implemented CE in its entirety, it is not possible to test the hypothesis of whether CE can be successfully applied in the electronics manufacturing companies in South Africa (second objective of this thesis). Although the success rate is 100%, i.e., 3 companies out of 3 applied CE and were all successful, the quantitative data is not considered to be statistically significant enough to conclusively say that CE can be successfully implemented. It is therefore proposed to use the research method of triangulation [Leedy, p143] to support the findings of the industrial survey. This investigation will involve identifying the resources and tools used by the three companies to implement CE successfully. The presumption is that if the salient resources / tools are either difficult to acquire or cannot be fitted to the existing structure and organization of the rest of the companies in the electronic industry, then these factors are regarded as unique to the successful companies. However, if the investigation reveals that the resources / tools can be duplicated or can be made available (e.g. a piece of software for CE), then it will be safe to assume that given the easy and timely access to the right resources, a company can implement CE and can do so successfully if a proper implementation strategy is adopted. The findings of this investigation will be discussed in the next section.

Finally, the industrial survey has made it possible for the CE practitioners in the local electronics companies to share their views, give advice and warn of dangers of overlooking certain issues. These valuable contributions together with the literature review will help fulfill the third objective of this thesis by

deriving guidelines for managers of the electronics companies who wish to implement CE in their companies.

4.5 Enabling Factors of CE at Plessey, Conlog & Tek Logic

In this section, the factors that enabled the three companies, namely, Plessey, Conlog and Tek Logic, to implement CE successfully will be identified. It should be noted that this section will not look at how these companies implemented CE (since this has already been covered in section 4.2) but rather, will try to identify what resources or tools were used. The researcher will try to establish whether any of these resources were unique to the three companies.

PLESSEY TELLUMAT :

The environmental and technological factors that enabled Plessey to implement CE back in 1991 were the following :

- 1) Commitment to CE from all those who were involved.
- 2) Identification of a “champion” from each discipline who would be involved in the project and make up the CE team.
- 3) Training of the team players and staff in CE theory and practice.
- 4) Meeting customers’ requirements by constantly communicating with the customers, at all levels, by a wide spectrum of company staff.
- 5) Use of the existing computer based systems for sharing and accessing information over the Local Area Network (LAN). Plessey eventually developed its own tailor-made product information management software, called ENMAN, to meet the specific requirements for the products that Plessey manufactures.

CONLOG :

The company first became involved with CE towards the end of 1993 and the enabling factors identified were the following:

- 1) Top management was in favor of the CE approach.
- 2) Training of the team players on the theoretical aspect of the CE concept and team building exercises.

- 3) Integrating customers' requirements by keeping the customers aware of every change happening in the product development.
- 4) Use of Lotus Notes, which is a groupware software package, that allows members to share information on their existing network of computers..

Tek Logic :

When Tek Logic implemented CE in mid 1993, the enabling factors were the following :

- 1) Identification of a core CE team and of its leader.
- 2) Training members from different disciplines to work together in a CE team.
- 3) Fulfilling customers' requirements by meeting the system specifications of the products.
- 4) Using the e-mail feature in their existing LAN to share information over the network.

Summary :

The enabling factors identified above required mainly a different approach to the management of the human resources in a CE environment. Technologically, the use of a LAN and a groupware software package were enough to meet the basic needs of sharing information among the team members.

5. DERIVED GUIDELINES FOR THE SUCCESSFUL IMPLEMENTATION OF A CE PROGRAM

Organizations implementing concurrent engineering stand to reap rich rewards. Better-designed, higher quality products with shorter time to market mean higher profits, and trouble-free product introductions often win market share away from competitors. Starting and sustaining CE is not easy however. It takes dedication and discipline, as well as a sweeping cultural change. A world-class CE culture focuses on continuous improvement. It relies heavily on teamwork among all employees connected with a product's development, plus close relations with customers and suppliers.

In order for a company to successfully transform from a sequential and fragmented product development environment into a concurrent engineering environment, it is important to create a dynamic environment. The foundation of such a company is not cast in concrete, but rather in four interconnected dimensions. These four key dimensions are the organization of managers and employees, their means of communicating, their unwavering focus on what the customer wants, and the development process by which the product evolves, adapts, and continues to sell [Carter & Baker, p35].

Based on the literature review and the industrial surveys conducted, guidelines for the successful implementation of concurrent engineering in the South African electronics manufacturing industry have been derived. To support some of the arguments put forward in deriving the guidelines, some valuable comments and advice from overseas CE practitioners which have not been mentioned previously in this thesis have been included. These guidelines are discussed according to the four key dimensions of CE mentioned above.

The implementation issues discussed here have been tried and proven in the industry. All principles have been derived from real case studies and practical experiences. It is, however, not within the scope of this thesis to discuss all issues in detail, but rather to indicate the general trends and direction that an organization should take in order to implement CE successfully.

5.1 The Organizational Dimension of Concurrent Engineering

The existing culture and organizational policies in most of our electronics companies are often opposed to concurrent engineering, where it is necessary to match authority to responsibility in a meaningful context. Only in this kind of organizational arrangement will the employees within a company and its culture be supportive of the concurrent engineering environment and committed to its success. There are two managerial entities that inhibit and shape this dimension, namely, managers and the product development teams [Carter & Baker, p37].

5.1.1 The Role of Top Management

Vision comes from the top.

Top management's commitment to concurrent engineering is the first and most important thing needed to make the process work. CE must be top-down implemented, that is, the initiative for change must come from the very top. As in most successful major business changes, top management must be, at least, supportive and, hopefully, spurred to action. As will be discussed below, managers should play a key role in preparing the culture of the company for changes, including those involved in creating a CE environment.

Mr. X from Kentron, Pretoria, is adamant that top management commitment and involvement are paramount for the successful implementation of CE. The CE program at Kentron never passed the pilot stage and according to Mr. X, this was because management never endorsed the CE approach.

Mr. Fadl Hendricks from AECL believes that one should not invest much time trying to persuade non-believers. He suggests one should go first to managers who see the merits of the CE approach and get their endorsement. A successful first program goes a long way toward convincing sceptics and fence sitters as results speak for themselves.

Top management has the following responsibilities in providing an efficient organization for a CE environment :

❑ ***Managers must get the vision of CE.***

They must understand the implications of CE and believe in its value.

❑ ***Managers must prepare their employees for the culture shock of changing to a CE environment.***

People are used to doing things the way they have always done them in the past. If the way employees do their jobs is changed, this causes some amount of culture shock for most of them. This culture shock is a natural form of resistance. People resist change when it is not understood, is imposed, is perceived as threatening, has risks greater than its potential benefits or interferes with other priorities. Managers must, therefore, teach employees by means of seminars, presentations, teamwork sessions, etc. the concept of CE and clearly show them the benefits associated with CE. The employees must feel that they are contributing to the change. Mr. Celine from Conlog, warns companies that are about to embark on a CE program not to underestimate the people issues (the soft issues). In his opinion, these soft issues are factors that can make or break a CE program.

❑ ***Managers must not only show commitment but must stay involved.***

One of the keys to the successful implementation of CE is the support of hands-on managers. They must be totally committed to a CE operating philosophy. The support must reflect not just support by memo, but active participation through their own daily management of the engineering function. Bob Evans from Plessey Tellumat, is of the opinion that management presence would make a big difference in terms of motivating the team and showing their total commitment to the CE philosophy.

- ❑ ***Managers must be willing to create and empower product development teams.***

Managers must create product development teams and then empower those teams with the authority and responsibility to make decisions. They must continually assess the professional and technical needs of the team and provide the necessary training and education, tools, and rewards. The tools, in this case, are the computer systems, and other high technology capabilities essential for rapid communication of designs and information. Management can also motivate engineers to work well in teams by nurturing a team spirit that makes every member feel good with a job well done.

In a serial design process, each engineering discipline has its own vocabulary, priorities, and purpose for doing a design. Proper management is critical to bringing these disciplines together into a concurrent environment. Management must help the engineers obtain a commonality between vocabulary, priorities, and purposes in an effort to create a design. It must have a vision, and define what the group is going to accomplish as a team. Management also has the responsibility for keeping everybody on schedule. It must also ensure that one team member doesn't sit idle because of dependencies (on other team members or data being produced by other team members). A list of critical-path and non-critical path jobs will help fill the gaps that are bound to occur should one member be delayed [Maliniak, p39].

5.1.2 The Product Development Multi-Disciplinary CE Team(s)

The Team Building Aspects

A concurrent engineering environment necessitates the formation of a product development team with members from different functional departments. According to Shina, an effective product development team should be a synergistic group of engineers who are committed to achieving common objectives by working well together; sharing resources, information, and skill sets; using and learning from collective experience; and producing high-quality results. [Shina_1, p111].

The team building aspects of CE are just as important as the technical methods and techniques in developing successful new products. As companies introduce the concepts of CE, this will involve different parts of the organization working together for the first time. Shina further states that past conflicting departmental goals, missions, and adversarial relationships, if not managed correctly and positively, could adversely affect the success of the project team.

"The kinds of problems that will be encountered when assembling multi-discipline CE teams are problems that relate to the interaction of people on the team," states Robert Crawford, manufacturing and test manager at Sun Microsystems Inc., California [Siegel, p16]. "Historically, most electronics companies are engineering driven, and design engineers by nature are egotistical and not very accommodating of other people's input. The team leader, therefore, must have good people skills." According to Shina, teamwork is not a natural quality of engineers, since they tend to be competitive and are encouraged to become so by the grading systems at colleges and universities. "Team building training and concepts are very important to the future success of CE in electronics companies," said Shina [Shina_1,p110].

Depending on the type of products a company manufactures, a typical CE team should consist of members from the following key departments : R&D (design), manufacturing, marketing (sales), drawing office (CAD/CAM), finance (costing), quality assurance, and purchasing. People from less crucial areas participate as they are needed.

For most products, a customer representative should be on the team. Having marketing and sales people in the team are not enough to represent the customer's viewpoint.

If suppliers play an important role in product development, supplier representatives should be on this team as well. It is almost always cheaper in

the long run to buy something already available than to develop designs, tooling, and manufacturing expertise oneself. Development effort should be spent on the value that a company adds to the finished product and not on the ordinary components that go into it. The exception to this, is where proprietary components technology or processes are involved. Working closely with suppliers adds their expertise at little or no cost. They can often suggest better, less expensive ways to do things. Tying them into an organization's technology and production needs also speeds design and facilitates just-in-time manufacturing practices. Reducing the overall number of suppliers also lowers the overhead costs of purchasing, inspection, and record-keeping. Supplier information can be useful for estimating costs early in a project's design phase.

The number of members forming the team in a CE environment cannot really be prescribed as it depends on the size and complexity of the project. However, the following most common mistakes made when putting a team together should be avoided : making the team too big, or making the team too small. An oversized team creates too many lines of communication, causes too much overhead, and is too expensive. The complexities of the social interaction also increase greatly every time another team member is added, thus lessening the chances for a successful collaboration. On the other hand, an undersized team is like not having a team at all, because all the required disciplines are not represented. It, therefore, depends on the project manager's belief of what team size will work best. This view is also shared by Kleynhans of Tek Logic. According to Kleynhans, the CE team should not be larger than ten members.

How often the team should meet is a matter of how complex the project is. Basically, the team should meet as often as need be. The more often they meet, the better it is, since problems can be detected and solutions found sooner. This a viewpoint shared by most CE practitioners.

The Choice & Role of the Team Members

What criteria should be used in selecting the members of the team from the various disciplines ?

A good way to assemble a team is to look for qualified workers in house. Welcome experience, but not at the expense of creative thinking. CE players must be able to influence others and tolerate significant changes in their job responsibility. The members need strong interpersonal, general problem-solving, and analytic skills, as well as an understanding of the business's goals and organizational dynamics. All of the South African companies surveyed have assembled their members based on their technical skills. Plessey chose the most experienced and skilled players. Conlog chose the skilled employees and considered their capability to integrate in the team. Tek Logic picked a champion from each discipline. At AECI (Pty) Ltd., the following issues were considered when selecting the team members :- technical skills, personality, team integration, and their position in the company.

Each and every member of the team has a very important role to play in the team. They should be aware of the values of teamwork, the sharing of ideas and goals beyond their immediate assignments and departmental loyalties. These are skills that are not taught to engineers in their formal education in S.A. technical colleges and universities. These characteristics should be valued just as highly as the traditional engineering attributes of technical competence and creativity. The successful new product interdisciplinary teams are those that are focused on aggressive but achievable goals for concurrent engineering. Teamwork and cooperation can be rewarded by evaluating these characteristics during a performance evaluation process for engineers.

Team members need to be motivated. For this to happen, they need to believe that the overall goals of the project are worthwhile. Beyond this, emotional commitment is derived from knowing that they are making a significant contribution to the project. Their sense of motivation derives from their feelings of contribution and involvement. Even big business is learning that engineers are more motivated by the opinions of their peers than by financial rewards or the

opinion of upper management. Team members must work in an environment that fosters complete openness with everyone on the team. There is no room for petty jealousies, office politics or information hoarding. According to Bruce Layne who owns Advanced Digital Products, Inc. [Layne, p61], ideas grow fastest when they are shared in a frenzied technical exchange. This effect is one of the best examples of synergy, where the collaborative product is far greater than the sum of the individual contributions.

Decisions reached by team members should be unanimous. Everyone will not initially agree on the proper course of development, but a cooperative discussion will always lead to an agreement. When this does not happen, it is usually because there is insufficient information to make the decision. At that time each team member should gather more information, with the goals of sharing results and narrowing options. No one should feel his or her contribution is less valuable than anyone else. All ideas should be discussed as equals, and the best should be pursued.

The Choice & Role of the Team Leader

The most crucial position on the team is that of the team leader. Top management should select that person very carefully, as he or she will direct the cross-functional team and the entire development effort. Many projects get delayed by power struggles between departments. The team leader should be of sufficient stature with colleagues and top management to ensure that this does not occur. To run the project efficiently, the team leader should have budgetary and personnel authority for the project. Members of the development team should report directly to him on all aspects of the project. Granting such authority to the team leader seems necessary because if it is not granted and people are assigned to the team only temporarily, they will still report to their old bosses. Those bosses will often pull the team members away for work on other projects.

According to Shina [Shina_1, p114], the leader represents the team to the management. His or her job is to act as the conduit by which the project team continues to receive proper resources of people, equipment, material, training,

and support from the organization. He or she reports on the project schedule, and alerts management of upcoming concerns and difficulties. Successful project team leaders are not those who autocratically manage by fear, but are those who command respect and confidence among team members.

An important aspect of the management role for the product development team leaders is the focus on "people or soft issues." The literature review and the industrial survey showed that the team leader can contribute towards successful accomplishment of the team's mission as follows:

- Select and recruit a well balanced team, in terms of technical knowledge, skills and experience. A team should not be made totally of senior experienced engineers but should leave room for new engineers who are on the upward swing of the learning curve to grow while experienced engineers mentor them. The achievement of personal success and professional advancement through team cooperation and strength is the formula for the total success of the organization. Time and resources for team development should be made available: training, team building, and enhancing written and oral communications.
- Define a common vocabulary so that teams can communicate with one another in an understandable and useful way. One way of achieving this, is to compile a standard manual which explains the technical terms which are used in the different disciplines.
- Assign responsibilities which match team members' capabilities. Allow each member to reach their potential by giving them free reign in their areas of expertise. Evaluate each member's progress, solicit opinions from throughout the organization, and provide timely and correct feedback. Always give credit where credit is due.
- Keep the team well informed on the management perspective and the state of the project and the company in general. Facilitate and encourage

communications and free flow of ideas, both within the team and with other departments. Allow team members to make decisions in their domain, and to represent the team in making presentations to management and negotiations with other departments and suppliers.

- Reorganize the team to meet changes in project goals and technical needs. Recognize when a stumbling block is preventing further progress. Seek help from the team members, management, and other sources.
- Act as the team's point person in recognizing and removing obstacles. Resolve conflicts by seeking problem solving techniques.
- An important way to motivate team members to reach decisions that resolve differences - in effect, to focus their actions toward a common purpose - is to arrive at decisions through consensus. A team reaches consensus when it finally agrees upon a single alternative and each member of the group can honestly say to each other member three things:
 1. I believe that you understand my point of view.
 2. I believe that I understand your point of view.
 3. Whether or not I prefer this decision, I will support it, because it was arrived at in an open and fair manner.

The project team leader is the most important member of the team. Project leaders are developed, not born. With the correct mix of leadership, delegation, and technical knowledge, project leaders will complete their projects successfully.

5.1.3 Team Training and Building CE Awareness Among Employees

It is management's role to conduct formalized training to help break down barriers and create a cultural change that fosters teamwork, communication, and group decision-making among the team members. Team building and problem-solving skills should form the core of the team training, with auxiliary workshops focusing on management skills and conducting effective meetings. At Hewlett Packard, the project team takes collective training in areas such as team development, conflict management, and personality type analysis. At Chipcom, training in management skills, QFD training, team building, performance appraisal skills, and technology training are very common. These training sessions are crucial to the success of the CE process, since it is recognized that a change in culture requires a great deal of time and education for all employees to make it work.

Building CE awareness among employees is also crucial to the success of a CE program. Unless employees are taught what CE is about, they will not feel that they are part of the CE process and will, therefore, not cooperate with management to make CE work. It is therefore, important to initiate training and develop instructional courses for creating CE awareness among employees. They should also be taught the skills of implementing and practicing CE.

The greater the number of people who are aware of a problem, the more people are available to solve it. Given the right information, design and manufacturing people will frequently devise unanticipated, novel solutions because they know their part of the business better than anyone else. And an employee participation program can boost morale and interpersonal communication throughout the company, which creates the environment necessary for CE to work. Employee participation often yields critical information and is financially helpful, but employees need to know that someone is really listening to and considering their ideas and suggestions.

Management should therefore be receptive to new ideas, be flexible enough to implement them when justified, and project a "can-do" attitude.

5.2 The Communication Infrastructure Dimension of Concurrent Engineering

The second key dimension of a CE environment is the communication infrastructure - any system, equipment, and software that facilitates the meaningful transfer of information relating to the product. CE requires that one or more teams work and share information in an integrated product development environment; therefore, effective communication is critical to success. Good communication is always important, and a sound infrastructure makes communication possible - linking people, ideas, specifications, processes, and feedback. Relevant information from the other three dimensions should permeate this dimension and be available as team members need it.

However simple or complex the product is, communication issues arise that can thwart team activities. Even when teams are clear about the purpose of their work and their priorities and have plenty of employees, enough time, abundant materials, and adequate technology, the overall purpose of the team effort - task, project, or program - does not always succeed. As product complexity increases, the development of the product can fail before reaching its technological limitations if a communication infrastructure does not support the necessary kinds and volume of information. This infrastructure must also expedite important information to the right people [Carter & Baker, p45].

The CE environment does not focus on numbers of people in determining the shape and contents of the communication infrastructure dimension, though clearly it is a factor. The more people involved in a project, the greater the chances of poor communication. According to De Castro, technical marketing manager at Mentor Graphics, as the CE team increases in size, the number of possible communication paths between individuals goes up by the following function, where n is the number of member on the team : [De Castro, p73].

$$\text{Potential Communication Path (n) in a project} = (n^2 - n) / 2$$

10 person project $(100-10)/2 = 45$ paths of communication

100 person project $(10,000-100)/2 = 4,950$ paths of communication

1,000 person project $(1,000,000-1,000)/2 = 499,500$ path of communication

The rapidly escalating number of paths is why the issue of communication and organization has become paramount in managing concurrent engineering. On a 1,000 person project, even if 99% of the communication paths are eliminated, that still leaves nearly 5,000 paths! But nowadays with the advent in computer/ information technology, thousands of communication paths between thousands of people can be accomplished rather simply through electronic mail. According to Dr. Minnaar of Plessey, without a computerized support system, CE's potential for enhancing product development is constrained by the ceiling of human capability. He reckons that a computerized support system is the only way to achieve the real-time transparency of information to all team members that CE requires.

To a great extent, product complexity determines the number of disciplines involved, and both of these determine the type of infrastructure needed to share information. The more components and disciplines, the more varied and unintegrated the component data is. This requires a more complex infrastructure that can integrate the data and keep everyone informed about activity in the CE environment and each person's respective role.

A 1986 IEEE survey [Minnaar_1, p5] found that design engineers in the electronics field typically spend less than 10% of their time designing new products "right the first time" and only 20% of their time doing actual engineering work. The rest of the time was spent on meetings, searching for people and information and coordinating with other engineers. Proper information technology, and the latest software tools directly address these issues.

5.2.1 Hardware Requirements for CE Environment

According to Kleynhans from Tek Logic, the minimum hardware communication technology needed to do CE is an integrated computer network system with electronic mail (e-mail) capabilities of sending messages to any other person connected to that network. Also, all the players involved with a CE project must have access to a personal computer (PC) connected to the company's wide network for the sharing of information, computer-aided design (CAD) drawings, computer-aided manufacturing (CAM) assembly drawings, etc.

Some people might argue that a computer network is not necessary to implement CE. They are right. The environment in which they are working looks is probably a CE team of five or less players, located in one room, working on a simple project.

Unfortunately, it is not always possible to locate all the project team members in one place and a project will not always be simple. Space availability is one of the reasons why the desired togetherness is not always possible. In that case, a computer network will help the team members communicate as fully as is desirable electronically, no matter how far apart they are and therefore, improve the productivity of the team players and make the CE process more efficient.

Before embarking on a CE program, it is important for a company to assess its current computer network systems and make provisions for future expansion. At this point, as Mr. X from Kentron pointed out, it is important to ensure that the computer network is an open system, i.e., it will be possible to integrate any other system to it without having incompatibility problem. Without an open system, there is always the risk of being stuck to only a few product makes. If there is a better software tool in the market which is not compatible with the network system in place, then that tool cannot be used. This is exactly what happened to Kentron and Mr. X would like to warn people not to make the same mistake.

5.2.2 Software Requirements for CE Environment

The success of CE has prompted many software companies to invest in applications suitable for a CE environment. According to Parametric's Strategic Relationships Consultant, Olimpio DeMarco, CE is working for the industry, and CAD/CAM suppliers are now designing their tools with this in mind. [Anonymous_3, p14].

CE is more than just teamwork nowadays. Computer-Aided Design (CAD), Engineering (CAE), and Manufacturing (CAM) tools are now playing a big role in a CE environment. The latest computerized tools are making CE much easier. Computer-Aided Design (CAD) systems now capture, in three-dimensional models, all the information needed by such "downstream" functions as purchasing and manufacturing. Ongoing efforts to standardize CAD data mean that it is possible to work on the same model with the various brands of CAD and Computer-Aided Engineering systems owned by a company and its suppliers. And new electronics data-management systems ensure that all team players use the latest version of design, not one that was updated hours or days early by another department. So, unlike a few years ago, it is now feasible to do CE on a global scale, linking hundreds of engineers around the world [Port & Schiller, p68].

According to Chris Demster, managing director at CAD/CAM Systems, Johannesburg, technology, in particular, CAD/CAM technology, provides many opportunities to address the issues of CE [Demster, p22]. For example,

- 3-Dimensional integrated parametric wireframe, surface and solid modelling allows designers to create highly accurate unambiguous product geometry in far less time than was previously possible. With the visualization tools available these digital components can be examined at length to determine their suitability for purpose. Changes are easily accomplished by modifying design intent or individual parameters.

- Assembly design software provides multiple users with concurrent access to assemblies whilst providing control over the security of the assembly component geometry. Individual users can simultaneously view the changes made by others working on different parts within the same assembly thus greatly accelerating the product development process.
- Schematic capture systems integrated with Printed Circuit Board (PCB) design and design simulation tools allow the electronics engineer to layout, test, and modify a complete board without laying a single copper or gold trace. Furthermore these PCBs and electronic circuits can be integrated within the mechanical assembly environment to provide a total digital mock-up of the finished product.
- Engineering data management (EDM) systems provide the framework for capturing, storing and managing corporate wide engineering data in one data repository, distributing this data as a corporate wide resource, controlling project and process flow, accessing data in a format meaningful to the specific user manner and interfacing to the company's financial material requirement planning (MRP) systems [Demster, p22].

According to Seth Hunter [Hunter, p28], research manager at Brown Associates, if there is a downside to CE, it probably lies in the blizzard of electronics documents and drawing data that flies back and forth during a typical project. This sort of environment produces the fundamental problem that it can be tough to guarantee that everyone on the team is working on the most up-to-date version of the design. What's worse, data for a single design can sit in dozens of unconnected databases. There's a huge potential for wasting hundreds of hours unknowingly by working on an outdated version. Just finding the right drawing file can be a challenge on a system containing thousands of them.

Fortunately, there are special types of software that have been created just to manage such difficulties. Product Information or Data Managers have a range of handy features for controlling mountains of engineering information. In fact, CE

teams find that Product Information Managers (PIMs) or Product Data Managers (PDMs) software are an integral part of their efforts.

Figure 5-1 below illustrates graphically how PIMs/PDMs can help concurrent engineers [Hunter, p29].

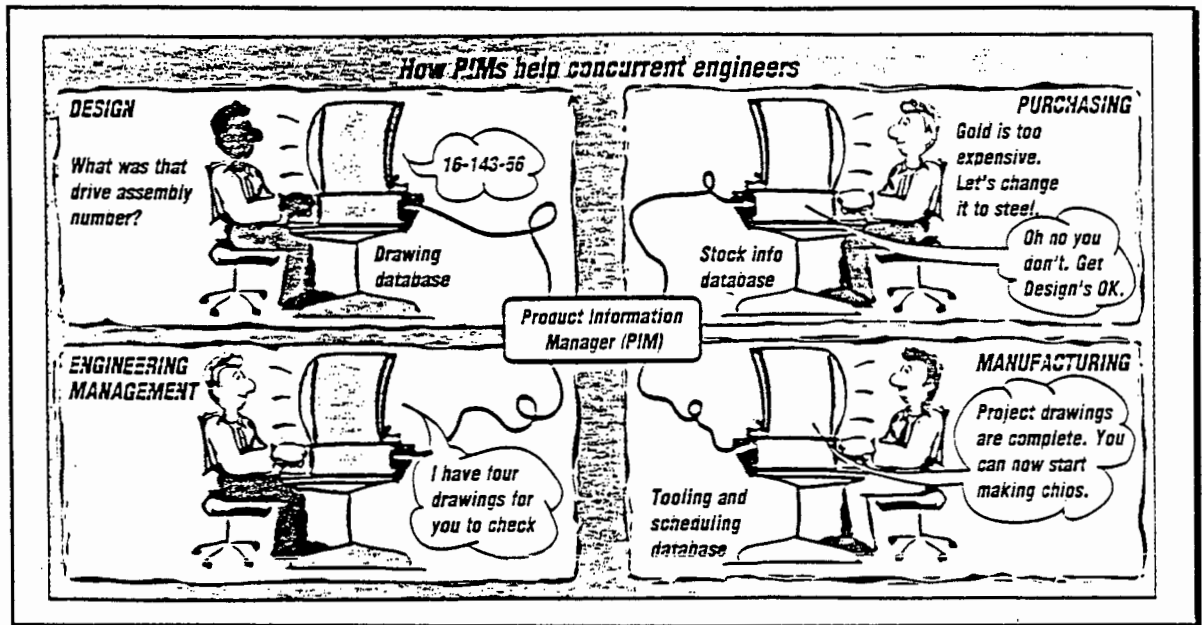

Figure 5-1 : How PIMs/PDMs help concurrent engineers

PIM or PDM come in many forms. According to Kempfer, what started out as software to handle CAD documents in the early 1980s has evolved into sophisticated systems that can track products from conception to obsolescence and disposal, at the same time providing clear lines of communications between all of the company's departments. Some consider PDM/PIM as the glue that holds CE environments together. Others refer to it as a CE "enabler"

Some systems cater to small workgroups, others operate enterprise-wide. CAD/CAM vendors offer PDM/PIM systems, usually as add-on modules, that tie in closely to their CAD geometry. Other companies, such as Sherpa, Hewlett-Packard, and Structural Dynamics Research Corp. (SRDC), are selling enterprise-wide systems that are open, heterogeneous, and can launch

applications from anywhere in the network in order to access data [Kempfer, ppSS4].

PDM/PIM enables CE by allowing users in small or enterprise-wide work groups to access, distribute, store, and retrieve information from a variety of sources. PDM/PIM systems give engineers control over projects and drawings, as well as the ability to track them. Managers can determine who is responsible for review, notification, approval, and Engineering Change Orders (ECOs). In addition, PDM/PIM provides configuration and bill of materials management. A great advantage that PDM/PIM offers its users is visibility into a product's structure.

Most PDM/PIM packages are available in modules from simple document management to complex enterprise-wide systems, users can customize a package to fit their company's way of doing business. Also users can implement it one step at a time as their needs change.

PDM/PIM is not an out-of-the-box, fix-it-fast solution for all of a company's woes. Many times, the problem of implementing CE and PDM/PIM lies in a company's organization and culture. In order for PDM to succeed, it needs a champion. At a minimum, a company has to have one corporate officer who is willing to take responsibility for the effort. Michael Rudy, manager of Information Services, Eldec Corp.[Kempfer, pSS6], says that there are two ways companies can implement PDM/PIM - either through a directive from top management or it can grow out of a small work group. However, he adds, PDM/PIM rarely grows outside of small groups unless it has the support of top management.

Rolls-Royce Aerospace Group has placed the largest order ever for CAD/CAM software in the UK with Computervision. This new order represents a move from components design to total product modelling in which R-R engines will be designed, 'built' and proven on screen, before any cutting of metal or composites. Electronics product definition, as it is known, is expected to save the company millions in physical models employed prior to full scale testing, and further reduce time to market. Phil Ruffles, director engineering of R-R's

Aerospace Group, says that the need to get all players involved concurrently in sharing and co-ordinating data at the design stage is fundamental to the success of their electronics engine design [Ruffles, p8].

5.2.2.1 Commercially Available CE Software Support System

What should you look for when buying a CE software?

According to DeMarco [Anonymous_4, p24], the answer lies in the fact that engineers should have more time to improve their designs instead of spending days to learn complex math's and computer systems. This means that software should be intuitive to engineers, feature-based, parametrically driven, and should have a single data structure. Above all it should have single a data structure that automatically updates changes to a model being used throughout design, analysis, and manufacturing independent of where the changes occur. Also, detailed assembly, and process drawings should fall out as a natural consequence of design modeling. Finally, manufacturing information should include associative process plans, tools path, bills of materials (BOM), and tooling and dies.

While PIM/PDM products may appear similar, each has notable features. Below is a list of some currently available commercial PIM/PDM software designed for CE application. However, it should be pointed out that due to continuous improvements in software development, the researcher's advice is to check on the latest and most appropriate software available before committing oneself to any specific package.

1. I/PDM from Intergraph Inc.
2. BravoFrame from Applicon Inc.
3. EDM from Computer Vision.
4. Sherpa/PIMS from Sherpa Inc.
5. WorkManager from Hewlett Packard Co.
6. PowerFrame from Digital Equipment Corp.

7. Common Data Facility (CDF) from IBM Corp.
8. PowerDM from Digital Equipment Corp.
9. DMCS from SDRC.
10. Electronics-Design-Automation (EDA) Release 8.0 from Mentor Graphics.
11. Objectivity/DB from Objectivity Inc.
12. UniSolve from Unicad Software Inc.
13. Pro/ECAD from Parametric Technology Corp.

5.2.2.2 Tailor-made CE Software Support System

Plessey Tellumat SA has successfully tried CE on a few pilot projects and is in the process of developing its own computerized support system, called ENMAN [Minnaar_1, p136]. The basic principles of the support system are : multi-disciplinary integration and involvement in the organization; immediate transparency and accessibility of all product information; one platform from which all CE functions can be reached; information captured once and used many times and defined communication paths.

With the help of the ENMAN computerized support system and the literature review, the researcher derived the following broad guidelines for companies to use in developing and implementing a computerized system to support CE. They could be tailored to any organization's needs and capabilities.

The discussion of the support systems that follows is made under the assumption that the organization already has some sort of computer network installed and that at least some of the tasks associated with product development and production are computerized (i.e. Standard Component Description Files, an MRP system for the shopfloor, etc.).

Desktop Access to all Information

The first principle of the support system is that it must allow the team member to do all the necessary functions from one menu structure on his PC on his desk. From one login with one password, the team member should have real-time access to all product information. Ideally, product information should be presented to the different types of team members on an as-needed-basis.

Product Oriented Electronics Workgroups

In most organizations, employees work on more than one product simultaneously. The individual should therefore be able to select a product when he / she logs into the network and from then onwards, be focused and confusion between various projects is minimized. Team members are, therefore, linked into electronics workgroups across the various departmental file servers and other physical boundaries. With this approach, the physical location of a team member all of a sudden becomes of secondary importance.

Immediate Status Reporting

All team members must have access to the same information, without having to duplicate any information. If any information changes, this change must be evident to all users of this information immediately. All of this must be done in such a way that an employee with little knowledge of computers or networks can get access to the information in a secure way so that no information can accidentally (or intentionally) be corrupted.

Attractive and Friendly Graphical User Interface

It will be a good idea if the CE support system has a graphical user interface (GUI) Windows environment whereby icons could be used to represent the functions available on the system. Clicking on the graphical icon will then take the team member directly to the function he/she needs to perform. Windows does not only provide the desired GUI, but it also allows multi-tasking and the easy transfer of information between different applications. This functionality would be of tremendous benefit to any CE Support System.

Built-In checks and Balances

The user interface should not only be simple and user-friendly, but it should also have built-in checks and balances. This way any team member can use it, but without the ability to jeopardize the integrity of the information. Users should not have to enter passwords for every function, the support system should have built-in security groups. The support system automatically determines from the initial login who the user is and to which functions the user has access (and what level of access, i.e., read-only or full parental rights).

The checks and balances go beyond security; they also verify the integrity of the information. The system should prevent the user from entering useless or incorrect information. By intelligently looking at the information as it is entered, the system could help the user by doing certain calculations, or completing certain records automatically, based on the other information entered.

Implementing a support system under the above guidelines should make a significant difference to an organization. According to Dr. Minnaar, most of these principles have already been implemented in ENMAN and the benefits are already tangible.

5.3 The Customer Requirements Dimension of CE

"A design that meets specifications is the engineer's view of a good design. However, a design that solves the problem is the customer's view of a good design."

- Dr. Geoff Bunza, Mentor Graphics.

The third key dimension of concurrent engineering is customer requirements. This dimension has a given shape at a particular moment in time : the total set of customer, company, and industry requirements for a product. The focus of this dimension is customer requirements, and most requirements should be viewed, to some extent, in terms of factors that affect customer satisfaction. A company must determine what a customer wants, ensure that a customer is getting it, make sure the product meets internal company standards and external industry standards. In every activity of product development, customer requirements are the main yardstick that should be used to measure progress and quality.

In the 1990s, success will be the result of understanding customer needs, developing a product to meet those needs, bringing that product to market at a fair value, and - most importantly - convincing the user that your product can improve their productivity, quality, and profitability. It is, therefore, necessary to use a reliable method to design products that meet customer requirements. One management method widely used in many Japanese and American companies is the Quality Function Deployment (QFD) process. According to Donald Hall, chief engineer of the Computer-Aided Acquisition and Logistic Support (CALS) Policy Office of the US Department of Defence [Hall, p24], in putting the techniques of CE into action, the quality function deployment (QFD) method is the method that must be used. Once customer requirements are well-defined, the product specifications can be focused on what the customer really needs. This is especially true for evolutionary products, where the customer is aware of the choices and capabilities of what is really on the market.

In South Africa, the three electronics companies that have implemented CE are not using QFD as a means of integrating customer requirements into the product development yet. At the moment, these requirements are met by either constantly communicating with customers at all levels by a wide spectrum of company staff or meeting customers requirements by keeping the customer aware of every change happening in the product development. They have also been satisfying customer's requirements by meeting the system specifications of the products. They, however, agree that their unscientific ways of meeting customer requirements have many shortfalls and that they will be using QFD soon to gain the most out of their CE effort.

Quality Function Deployment (QFD) is a structured and disciplined process that provides a means for identifying and carrying the customer's voice through each stage of product and service development and implementation. QFD is achieved by cross-functional teams who collect, interpret, document, and prioritize customer requirements to identify bottlenecks and / or breakthrough opportunities [Corbett , p147]. QFD is a well-defined and well documented technique. A detailed description of QFD is beyond the scope of this thesis.

QFD methods in the conceptual stage of design are valuable in a number of ways. QFD focuses on quality from the customer's point of view and offers reasonable alternatives to engineering decisions. Quality is designed into a product - not added on. And as the effort to develop a product becomes more complicated, QFD promotes more interaction between product development teams that include a mix of disciplines.

It is however important to remember that there is no one path to product quality or the highest degree of excellence. So it is important for a company to be aware of the different approaches to quality that have been tried with success and to evaluate and use the one that works for a particular product.

5.4 The Product Development Process Dimension of CE

For each company and its product, this dimension has a fairly stable outline because of its integrated vision of the total product development process - from design conception to manufacturing and beyond. This approach considers downstream processes, and strives to continually improve the product development process. As might be expected in a concurrent engineering environment, all activities are ongoing and happening at the same time. Companies must concurrently enhance the product while assessing its status. Development processes must integrate all disciplines. Then the knowledge gained during this process of concurrent product development must be captured and recycled to provide for decision support and timely product and process enhancements - creating an environment of continuous change and improvement.

5.4.1 Planning the CE Process

For planning purposes, a series of events spanning a product's cycle are specified in a matrix. The events are delineated by function and by phase. This group of predefined events, which are based on Hughes Aircraft Co.'s Electro-Optical Systems past experience and the industry's best practices in product development, becomes a shopping list for new developments from which to choose during CE planning [Mackey, p35]. Only the events most useful for the new development are chosen, based on customer needs. Integrating the events should marry the defined program tasks. The result is an event matrix that can be tailored for a specific development program. Table 5-1 next page shows the function-by-phase matrix.

Table 5-1 : A function-by-phase matrix

Program Phase	Concept	Advanced Development	Full-Scale Development	Pilot	Production
Program Management / Marketing	<ul style="list-style-type: none"> - Start with event planning - Identify front end of business team - Pick bid or no bid - Undertake risk management 	<ul style="list-style-type: none"> - Devise plan of life-cycle cost - Use hardware work breakdown structure 	<ul style="list-style-type: none"> - Devise plan for improving productivity - Empower CE team as to costs 	<ul style="list-style-type: none"> - Move technical data package into manufacturing - Devise marketing plan 	<ul style="list-style-type: none"> - Set maximum rate requirement - Plan for sale in alternative markets
Design Engineering	<ul style="list-style-type: none"> - Work out specification flowdown - Undertake design review - Devise system engineering plan 	<ul style="list-style-type: none"> - Make computer-aided design drawings - Decide on software / hardware partitioning 	<ul style="list-style-type: none"> - Plan the configuration management - Plan qualification testing - Specify tests 	<ul style="list-style-type: none"> - Set up line support training - Analyze field failures 	<ul style="list-style-type: none"> - Design for alternative markets - Defined specification relief
Manufacturing / quality engineering	<ul style="list-style-type: none"> - Review quality requirement → - List QFD design features → 	<ul style="list-style-type: none"> - Plan software development - Plan co-location 	<ul style="list-style-type: none"> - Evaluate hazardous material → - Perform manufacturing simulation - Make plan for statistical process control 	<ul style="list-style-type: none"> - Start Taguchi design of experiments - Write report on statistical process control 	<ul style="list-style-type: none"> - Set up support pool - Certify operators - Minimize testing
Producibility	<ul style="list-style-type: none"> - Devise producibility plan - Establish benchmarks → - Design for manufacture and assembly → 	<ul style="list-style-type: none"> - Utilize 3D modeling - Plan implementation - Review drawings → 	<ul style="list-style-type: none"> - Establish guidelines for testability & manufacturability - Do tolerance analysis 	<ul style="list-style-type: none"> - Devise rate process plan - Optimize assembly 	<ul style="list-style-type: none"> - Improve materials and / or technology - Improve capital investment
Supplier	<ul style="list-style-type: none"> - Review - Prepare sole-source report - Devise program material strategy 	<ul style="list-style-type: none"> - Qualify supplier - Devise standard contracts 	<ul style="list-style-type: none"> - Devise critical parts plan → - Negotiate rates 	<ul style="list-style-type: none"> - Plan just-in-time production - Establish packaging requirements 	<ul style="list-style-type: none"> - Optimize material flow - Write report on inventory and work in process
Design to cost	<ul style="list-style-type: none"> - Devise cost model → - Set up unit bogeys - Establish design-to-cost reporting system 	<ul style="list-style-type: none"> - Decide whether to make or buy → - Discover cost drivers - Set up module bogeys 	<ul style="list-style-type: none"> - Write report on design-to-cost problems - Track costs → 	<ul style="list-style-type: none"> - Fore cast profits - Rate "what ifs" 	<ul style="list-style-type: none"> - Assess alternative market effects - Optimize rates
Reliability	<ul style="list-style-type: none"> - Establish service requirements - Devise computer-aided logistics system plan 	<ul style="list-style-type: none"> - Arrange for special service equipment - Identify reliability drivers 	<ul style="list-style-type: none"> - Establish depot requirements - Plan training - Get feedback from field 	<ul style="list-style-type: none"> - Publish manual - Train the field - Get feedback on failures 	<ul style="list-style-type: none"> - Update manual - Set up depot

Activity continues in all subsequent phase to the right → symbol

5.4.2 Functional Roles in CE Process

An important step in implementing CE in an electronics company is the recognition of CE as an important part of the company's competitive strategy. CE should be included in the goals and objectives of the overall organization, with each department having its own set of strategic plans that match the overall CE plan [Shina_1, p104]. Instituting a concurrent engineering program requires a serious commitment from every level of management and a close look at the design, engineering, and manufacturing processes. Managing this change positively in the company's methods and procedures requires careful planning and facilitating to ensure success.

The ownership of CE should not belong to one particular group but should be shared equally among all. The role of the company management is to understand some of the inherent process changes in CE, such as longer initial development cycle but reduced overall cycle and the measurement and continuous improvement of the current levels of product cost, testability, quality, reliability, and serviceability. In addition, it is important for the management to understand the issues of concurrent engineering and to set operational goals and measures that are in line with current product design and development practices.

The Role of Design Engineering Department in CE Process

The design engineering department's role in CE is the understanding of the issues of manufacturability, testability, reliability, and serviceability. New product plans should be developed only after clear understanding of the current levels of these issues in existing products. In many companies, these levels are not apparent. It is important that the design department does not estimate these levels but insists on the appropriate department, whether it is manufacturing, quality, marketing, or sales. These departments must supply the design department with their best estimates of these numbers in order to set baseline levels and ultimate goals for new products [Shina_1,p104].

In establishing a new product development strategy, each of the CE plans and goals should be clearly outlined. The goal statements and the action plans used to achieve them should be formulated with cooperation from the other departments. The milestones and major project checkpoints for new products should contain progress updates on CE goals.

From the survey carried out, it was found that the R&D (design) department is the most reluctant to cooperate in a CE program. It is, therefore, important for the design department especially, to be more accommodating and responsive to the need for better cooperation.

The Role of Manufacturing Engineering Department in CE Process

Manufacturing engineering department's role in CE is the characterization and documentation of the current process, and its communication to design engineering. Design guidelines for existing and future manufacturing processes should be published, and updated to the most current state as equipment is purchased and the processes are enhanced. In addition, manufacturing has to control and continuously improve the quality of the current process, and outline its long-range plans in terms of equipment, people, and information flow.

Characterizing the manufacturing capability and constraints is the key to the success of CE. Process capability measurements can be a direct result of maintaining statistical quality control on the production process. A target plan for continuous process improvement and its results should be communicated regularly to the design engineering department. Failure data should be considered not only from factory processes but from field failures and warranty reports as well.

The long-range plans for manufacturing in terms of process capability, automation, test, supplier certification, delivery and distribution, and people training and recruiting efforts should be made in line with the company market strategy, and after consultation with the engineering department. Technology

risks in manufacturing plans, such as the decision when to maintain an old technology or to jump ahead with a new technology, should be made in the light of the new product development plans.

The Role of Other Departments in CE Process

Other departments, such as quality, marketing, purchasing, and field service, should also be involved in the CE process to set the current baseline of quality, reliability, service, and repair of current products.

Marketing should play an important role in focusing customer inputs by using tools and techniques such as quality function deployment (QFD).

Since most products made contain purchased parts, CE must also encompass suppliers. Suppliers / vendors must be brought in on day one, to get the same head start as the rest of the product development team [Woodruff, p66]

The quality department should provide the audit function on the quality data being generated at the production floor, as well as the reliability data being generated in the field. Quality should not be the sole responsibility of the quality department but should be the concern of all parts of the company.

The field service department should input very strongly into the design of new products in order to facilitate the serviceability and the repair of electronics products.

Typically, larger companies must continuously examine the four dimensions of CE and adjust each one to bring it into balance with the others. Each dimension has its own internal factors that can be strengthened and can affect the entire environment. Understanding these dimensions makes the company's shift to a CE environment both possible and manageable. One is able to assess to what degree these dimensions are already in place and working effectively.

5.5 Establishment of Pilot CE Projects

After recognizing the importance of CE, it is necessary to decide where and how to start its implementation. CE should be gradually implemented on a series of pilot projects, because it is too complex to implement across the entire organization at once. As Machlis from Digital Equipment Corp. (DEC) suggests, companies should not try to overhaul their structures in a single stroke. Instead, he recommends companies to pick a small project and staff it with top people. If the project works, the company can promote the success throughout the organization - the "divide-and-conquer" approach [Machlis, p37].

Establishing pilot CE projects gives first-hand experience in CE migration strategies for real product-development environments. As the organization becomes familiar with CE through these pilot projects, more and more projects can be approached with CE until, eventually, the whole organization uses CE as the default way "*of getting things done around here.*"

A prerequisite to identify a CE pilot project is to know what the goal of CE is. CE aims to produce a new product in as short as possible a time, with the highest designed-in quality at the lowest possible production cost. To achieve this, CE requires that the organization's resources, knowledge and expertise be integrated and considered in parallel, across all factors that may influence the product over its life-cycle, and this must be done as early as possible during development.

The sections that follow discuss the factors that need to be considered when selecting a pilot CE project. But before that, here is what the South African CE practitioners advise :

- Mr. J. Kleynhans (*Tek Logic*) - Pick a project that has known issues and involves all the desired departments within the company. The term issues refers to the employment of established technology; meaning there is no need to carry out basic research to develop the product.

- Dr. S. Minnaar (*Plessey Tellumat*) - Choose a pilot project which has a tight time and cost constraint. The aim of the pilot CE project is to prove that CE can achieve its goals within tight time and resource constraints. The pilot project should also be a short one, so that the results and lessons of the CE effort could become visible quickly and applied to other pilot projects as well.
- Mr. D. Celine (*Conlog*) - Choose a neatly defined project that could stand on its own (i.e. not related to any other project) as the pilot project to apply CE principles on. The objectives, the time scale, and the budget allocated need to be clearly stated.
- Mr. X (*Kentron*) - The project targeted for pilot CE project should utilize existing technology and involve all departments committed to CE.

5.5.1 Identify Projects, not Areas

According to Mr. Celine of Conlog, a common mistake organizations make is to attempt CE in a single department or function. CE cannot be applied to a single function, due to its very nature of being a cross-disciplinary approach. CE should be applied horizontally across the organization, not vertically within a function.

5.5.2 The Type of Project to Look for

According to Dr. Minnaar, it is very important to choose a proper first pilot project. The performance of this project will determine to a large extent the acceptance of CE across the organization. At Plessey-Tellumat, the first CE project was a huge success, making it much easier to sell the idea to team members on the second and third projects.

Development projects fall into many categories, not all of which are suited for the CE approach. CE's multi-disciplinary, fast, parallel approach that focuses on the product, is more suited to high risk, speed-critical projects, than product upgrades where manufacturing alone plays a major role or where

technical advancement alone is the dominant factor. CE is more suited to an autonomous, stand-alone type project where all disciplines will have to contribute. A "newness" matrix [Minnaar_1, p81], as shown in figure 5-2 below, can be used to determine whether CE would be applicable.

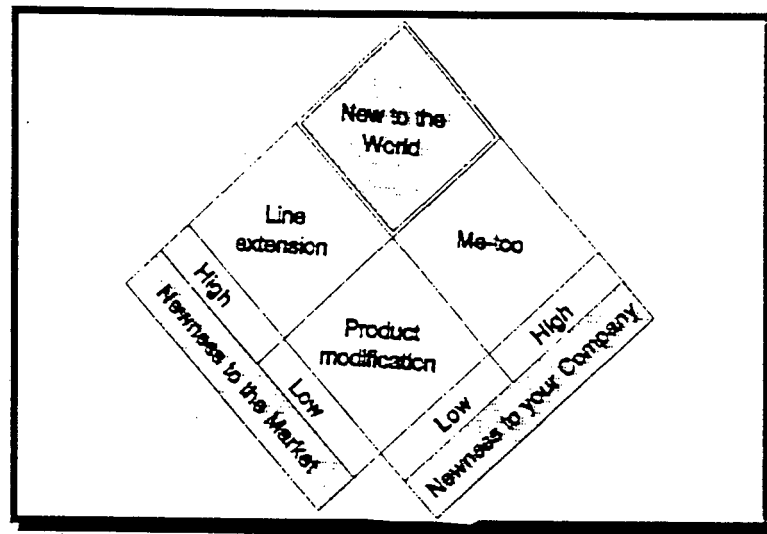

Figure 5-2 : New product characterization

The type of product that is "new to the world" would be a good choice for CE, because its time-to-market, price and quality would be critical.

The matrix is not absolute though; Plessey-Tellumat has successfully implemented CE on both "new to the world" and "product modification" products. The product modification development was chosen because of the importance of time to market and cost; the modification been enforced by competitive pressures. The return on effort on the "new to the world" project was, however, more significant.

5.5.3 Criteria for Selecting Pilot CE Projects

Once the character or type of the potential pilot project has been determined, the actual project choice should be further refined by the following criteria [Minnaar_1, p82].

- The project should not have started yet. It is not effective to apply CE on a project that is already underway, because the project has to be planned differently from the start.
- It must still be possible to select the project team. Teamwork is vital, so care should be taken to rather choose good team players than brilliant individuals.
- The project must have tight time and cost constraints. The aim of the pilot CE project is to prove that CE can achieve its goals within tight time and resource constraints. Ideally the pilot project should be short, so that the results and lessons of the CE effort can become visible quickly and applied to other pilot projects as well.
- The project must be important to the organization. Selecting a small, unimportant project will send the wrong message to employees. Employees need to see that management is serious enough about implementing CE that they are willing to use it on an important project.

5.5.4 Planning the Pilot CE Project

It is not practical to suggest the optimum number of pilot CE projects, time scales or cost that an organization should or should not spend on a CE program, because organizations are so diverse. This section rather discusses how to plan a specific CE pilot project, once it has been identified. The emphasis is on what to do differently than with normal development programs.

CE requires a different culture in a product team's *modus operandi*. To ensure the successful implementation of this new culture, the CE project should be planned meticulously. This plan should be made transparent to the product team members and the program manager should continuously monitor the adherence to the plan. The following issues should be addressed even before the project is launched [Minnaar_1,p90]:

Project Leadership :

CE requires very good project leadership and program management. Therefore he/she should meet the criteria outlined above in section 5.1.2.

Up front planning and team selection :

The project and its milestone must be very well, and realistically, planned, including the selection of the core team members. The project's team members will include people from all disciplines as discussed in section 5.1.2.

Realistic planning :

The project's time scales must be realistic, irrespective of how soon management wants the project completed. This calls for proper resource allocation from the functional line managers, who "lease" their employees to the project. The line manager must ensure that once he has committed a person to a project for a certain period, that person will be able to fulfill this commitment. Realistic resource allocation allows time for fire-fighting and other unexpected events. Unrealistic planning for one critical person can have a snowball effect throughout the project, causing havoc with the resource allocation of all the other departments.

Planned parallel activities :

The various parallel activities necessitated by CE should be planned. The project leader, with the help of his/her core team must decide beforehand where and when different functions will work in parallel. Without these parallel activities in the project plan, team members are likely to revert back to the old, sequential way of doing the project.

Continuous verification :

A CE project has more checkpoints than the traditional project, because activities occur in parallel. More frequent checks (verifications or milestones) must be made to ensure that this fast project is heading in the right direction. These verifications do not have to be formal design reviews by senior

management; they can be informal meetings of the core team. Verifying the development in smaller chunks ensures that verified chunks can be passed on to the next function, enabling parallel work with confidence.

Training and education :

A team cannot be expected to live up to an expectation that they do not know. Team members must be trained and educated in the principles of CE, specifically on the differences between a CE project and the projects they are used to. Team members will then know why the project needs to be done, how it will be done and who will be responsible for which tasks.

Different culture :

Sharing of information between different functions requires a culture change and should be encouraged by the program manager. The "us vs. them" syndrome between R&D and manufacturing must be broken down with CE.

Multi-disciplinary involvement :

Depending on the nature of the project, it might be necessary to locate the different disciplines into one location for optimum cross-disciplinary co-operation and integration. However, in an organization which has an information system that will provide such fast and efficient real-time access to all project information, that physical co-location will be unnecessary. People can be electronically co-located into special network workgroups.

Patience :

Patience is the name of the game in the first CE project. Implementing the first CE project in a non-CE environment is difficult. Team members have to be constantly reminded of the CE responsibilities and the program manager has to check every parallel activity. Without these constant reminders, team members will just revert to the "old" way of running a project. Many people feel threatened by CE, because it puts more responsibility on the individual team member to perform, so they will be reluctant to follow all the principles.

The results of CE are also not visible up front, they will only become evident late in the project. The program manager (and functional management), therefore, need(s) lots of patience and resilience to make CE work. "Don't expect too much, too soon, " said Dr. Minnaar.

A pilot CE project requires much preparation up front from a heavyweight program manager who also possesses excellent program management skills, not to mention the vision to implement innovative ways to make CE work. A pilot CE project is, therefore, no mean feat and a special group of people should be hand-picked for the first project, since this project will determine the organization wide acceptance (or rejection) of CE.

5.6 Maintaining the Momentum of a CE once it is Established

One of the biggest problems with moving an entire company toward a CE environment is maintaining momentum for change over a long period of time. To maintain momentum, consider judging early success on only the achievements of the pilot program.

Also, have contingency plans if one of the pilot projects is unsuccessful. One bad pilot can wipe out the progress of many other successful ones. Carefully monitor the progress of each pilot to head off unforeseen problems early. Successful pilots should carry rewards for all team members, not necessarily in money terms, but in term of incentives.

According to Dr. Minnaar, momentum can be maintained by establishing a CE committee that plans, monitors and constantly improves on the CE implementation. Mr. Celine believes that it is important to develop structured project reviews whereby the CE process can be monitored constantly and continuous improvements can be made to the process.

Since the benefits of CE take time to develop; management needs to be enlightened and patient. They should be actively involved in managing the entire process. They must also monitor and help plan pilot programs, including

selection of participants who will lead and act as models in the evolution of new engineering roles. Finally, they need to help make adjustments to the plan along the way.

5.7 Benchmarking Your Company for CE

Benchmarking is the process of comparing products or practices against those of leaders.

The methods by which companies measure themselves and set performance goals do not always translate directly into CE goals. The optimum starting point for CE depends on factors such as individual company culture and actions of competitors. Effective benchmarking can provide a focus for CE projects by revealing areas for improvement.

What sorts of activities can be benchmarked in a CE effort ?

According to US firms that have successfully started their own benchmarking program, the following activities can be benchmarked [Anonymous_5, p44] :

- Cost Targets
- Number of engineering changes after release
- Number of production changes after release
- Time to Market
- Customer Satisfaction
- Quality of end products

However, before beginning the benchmarking process, it is important to have a clear understanding of the existing process that is agreed to and ratified by all those who are involved. This understanding must be clear and should be flow-charted. It is only after one has understood his/her own process that the existing performance can be measured. Then the areas that need to be improved and concentrated upon can be identified. Improvement ideas come from comparing one's own operation to that of the benchmarking partners, then doing a gap analysis.

At present, none of the South African electronics companies that have implemented CE are benchmarking their CE effort. This is due to the fact that these companies have only recently got involved with CE and that they are still improving on the approach. They will only be able to benchmark their process when their CE programs have been fully implemented and that each and every person involved in the process clearly understands his/her existing process.

5.8 Measuring Concurrent Engineering

CE addresses problem areas that are easy to identify, but hard to eradicate, often because of their intangible nature. However, it is imperative that the effects of the CE are measured. Measurements are also feedback that can be used as pointers for further action. Positive measurements are a very effective motivational tool. According to Dr. Minnaar, the results for CE measurements must be published on each and every notice board in the company, i.e. make CE visible. This view is also shared by McNamara of Chipcom. At Chipcom, a team is set up to address just the issue of measuring CE. The team uses four key metric categories which were discussed in further details in section 2.5.2 above. The key metric categories are:

- Customer Satisfaction
- People
- Product Delivery
- Financial Health

According to Shina, measuring CE involves measuring the aspects of the development process that are not directly related to product development and achieving product performance milestones. These measures should be kept up to date and used to set the goals of new product development projects. As a result, Shina developed a performance metric which is divided into four categories : [Shina_1, p115]

- Design Phase Metrics
- Production Phase Metrics
- Design Process Metrics
- People Metrics

A summary of these metrics is presented in Appendix IV.

These metrics are intended as a starting kit towards identifying important aspects of the design and development process. Many of the measures can be set to historical levels, or updated as the company's competitive position changes.

The design phase metrics are concerned with minimizing the level of engineering changes, and with factors applied to the definition to normalize these measures. They also measure the return factor (RF) of the project and the attention to staffing level and customer focus.

The production phase metrics are focused on the inherent benefits of CE : increased production, minimizing the number of engineering changes after product release, and the cost and quality of the product, both at the factory and in the field. Again, normalizing factors are applied in the definitions of the measures to determine the effects of technology and complexity of the product evolution.

The design process metrics measure the investment in capital equipment and processes for the company, and keep track of the progress on turnaround times for prototypes and assemblies such as PCBs, plastics, and sheet metal parts. In addition, the trends of these processes are also monitored to keep them within the general industry and competitive standards.

The people metrics measure the most important element of product development : the engineers and scientist working on the projects. Keeping the technical staff interested and motivated through prompt evaluations, training, and solid project assignment is very important to the long-term commitment of the company to its people.

5.9 Competitive Analysis

Competitive analysis is an aspect of CE that has been successfully applied at Sun Microsystems whereby a competitive analysis team purchases various "best-in-class" competitors' products and examined their favorable and unfavorable attributes. The result of the analysis can be used when designing the next new products and thereby continually improve new products that are released. One area of the competitive analysis that is particularly useful is the design for manufacturability (DFM) study. The manufacturing engineer can disassemble the unit and perform DFM analysis to the component level. As such, a quantitative design efficiency can be obtained for each product. When the manufacturing engineer performs the DFM analysis, he/she can discover various ways to modify his/her existing products, to improve product manufacturability. The manufacturing engineer can then perform "what if" and feasibility studies to determine benefits of subassembly redesigns.

The representatives of the competitive analysis team and the areas in which the analysis is concentrated were stated earlier in section 2.5.3. Although not many companies perform competitive analysis (none of the three local companies that use CE performs this analysis), it is worth mentioning that the result of the analysis can be vital for the survival for certain companies. Competitive analysis is a tool and companies should start using it.

6. CONCLUSIONS AND RECOMMENDATIONS

Based on the findings of this research, the followings conclusions may be drawn:

1) **Level of awareness of the CE concept :**

Out of the 32 managers of the South African electronics companies surveyed, it was found that 22 of them, i.e. 68.8%, were aware of the concept of CE. This level is considered to be significant due to the fact that CE is relatively new to South African managers. However, their depth of knowledge varied markedly. Only 5 of the 22 managers, i.e. 22.7%, claimed to be experts in the CE field. Eight, i.e. 36.4% rated their knowledge of CE as being good whereas the remaining nine managers, i.e. 40.9%, judged their knowledge of CE as poor. Based on these figures, one can reasonably conclude that the level of awareness is significantly high within the surveyed industry.

2) **Degree of CE Application in the local companies surveyed :**

The survey revealed that 22 out of the 32 companies surveyed, i.e. 68.7%, had never experimented with CE. However, there were 7 companies, i.e. 21.9%, that had informally applied CE principles in some of their projects and the remaining 3 companies, i.e. 9.4% had implemented a CE program in its entirety. The application of CE in the local electronics companies is certainly not high but the survey also revealed that 18 managers, i.e. 81.8%, of the above mentioned 22 companies said that they would consider using CE as an approach to gain competitiveness in the future. Therefore, there is a strong probability of an increase in the number of companies applying CE in the future.

3) **Can CE be implemented successfully in the local electronics companies?**

Only 3 out of the 32 companies surveyed have implemented CE completely. In all three cases, the implementation was a success. Because of limited data, it was decided to identify the factors or tools that enabled the three

companies to implement CE successfully. The investigation revealed the following :
The very first key factor involves team work which in turn relates to learning to work together in a cross-functional team and to get the backing of top management. Having a team with the team leader assigned to the CE project is not enough, there is still the prime need to train and educate the team members and any other staff about the concept of CE itself. Progress is achieved if people are knowledgeable about the concept and have a clear idea of what CE will bring.

Technologically, there is need for sharing information in real time. This is achieved via a network of computers and groupware software so that information can be accessed and shared in real time to increase groupwork productivity. Recent developments in both hardware and software are adding to the collection of tools available to increase the capabilities of many companies to utilize "paperless" Concurrent Engineering systems.

Thus, the survey indicates that there is as such no unique, impossible-to- acquire factor that adds to the success of CE implementation. The factors mentioned above can all be acquired or nurtured within the company itself. Therefore, a company interested in implementing CE will be able to set up the necessary resources, be it human, technological, or managerial in order to carry out the implementation phases.

As to whether the implementation would be successful, this will depend to the extent of their planning and implementation strategies.

The conclusion therefore, based on the fact that,

- 1) 3 companies tried implementing CE completely and were all successfully,
- 2) the enabling factors can be readily acquired by companies who wish to implement CE, and
- 3) 28 out of 32 (i.e. 87.5%) managers in the primary survey think that CE can be successfully applied in local electronics companies.

is that Concurrent Engineering can be successfully applied in the South African electronics manufacturing companies.

4) Deriving guidelines to implement CE successfully :

The in-depth literature review and the industrial surveys carried out have enabled the researcher to gather sufficient information to derive effective guidelines for the successful implementation of CE practices in the South African electronics manufacturing industry. The researcher attempted to back up all principles with real case studies and practical experiences from companies with successful CE program. These guidelines have been discussed in detail in section 5.

As a result of the findings and conclusions of this research, it is recommended that the local electronics manufacturing companies should apply the CE concepts without reservations and with enthusiasm and confidence. The guidelines derived can be used as a road map to put them on the right track towards a successful implementation. The vision of a concurrent engineering environment could represent a path toward continuing success. The concept of CE can be tailored to suit the culture of any organization, however large or small or however structured.

7. FUTURE DEVELOPMENTS IN CONCURRENT ENGINEERING

Once a company adopts concurrent engineering whole-heartedly, its culture must and will change. The old management structure is likely to prove inadequate in some areas, and key activities will be more concentrated than previously. People working on new projects will be more highly motivated than in the past, so that the gains inherent in CE can be compounded. However, unless the attitude of managers in the company toward design is changed, the full benefits will not be realized.

The future development in CE in any company has no arbitrary limits, no restraints imposed from outside. What CE becomes, depends solely on the flair and imagination of managers in the company.

In terms of technological development, the future will undoubtedly be the automation of the CE environment. The technologies of automation will be the enablers of productive change in trying to absorb and keep track of billions of bits of information. The increasing use of automation in the CE environment will be inevitable when a company has a philosophy of continuous improvement that searches for mastery of the product development process and realizes the desire to remain close to the voice of the customer.

Therefore, in the future CE will not just penetrate deeper into the companies that use it, but will change the fundamental structures of those companies, and of the industry sectors.

LIST OF REFERENCES

- Concurrent Engineering -

- Anonymous_1 : The Race to Market Heats Up. Machine Design, Vol.65, No.1, January 8, 1993. p14.
- Anonymous_2 : Concurrent Engineering Drives product Turnaround, Machine Design, January 24, 1994. pp18-19.
- Anonymous_3 : CAD/CAM Planning: Organizing for Concurrent Engineering. CAE, Vol.11, July, 1992. ppCC2-CC10.
- Anonymous_4 : How to make Concurrent Engineering Work. Machine Design, Vol.65, No.15, July 23, 1993. pp21-24.
- Anonymous_5 : How to make Concurrent Engineering Work - Part 5 : Benchmarking Your Company for CE. Machine Design, Vol.65, No.17, October 22, 1993. pp43-45.
- Burnett, R.W. : Ingredients for a Booming Start-Up : Collaboration, Communication, Consensus. IEEE Spectrum, Vol.28, No.7, July 1991. pp33-34.
- Brazier,D. : CE : Participating in Better Designs. Mechanical Engineering, Vol.112, No.1, January 1990. pp52-53.
- Carter,D&Baker,B: Concurrent Engineering : The Product Development Environment for the 1990s. Addison-Wesley, 1992.
- Charles, D. : Don't Toss It Over - Break Down The Walls. Automation, Vol. 37, No.6, June 1990. pp68-69.
- Cleland, D.I. : Product Design Teams : The Simultaneous Engineering Perspective. Project Management Journal (PMJ), Vol. 22, No. 4, December 1991. pp5-10
- Corbett, J. et al. : Design for Manufacture: Strategies, Principles and Techniques. Addison-Wesley, 1991.
- De Castro, J. : Concurrent Engineering Meets Design Automation. Electronics Design, Vol. 39, No. 1, 10 Jan, 1991. pp73-4, 76-8, 80,82.
- Demster, C. : The Role of Technology in Implementing Concurrent Engineering - A South African Case Study. Computer Graphics, Vol. 4, No. 5, October, 1993. pp20-22.
- De Souza, R. : New Generation of Automation Tools Unlocks the Benefit of Concurrent Engineering. Computer Graphics, Vol. 4, No. 3, June 1993. pp37-38.

- Evans, S. : Changing Your Way to a Better Business. Engineering Computers. Vol.10, No. 3, May 1991. pp12-13,15,17.
- Evanczuk, S. : Concurrent Engineering. High Performanec Systems, Vol.11, No.4, April 1990. pp16-18, 22-3. 26-7.
- Foreman, J.W. : Gaining Competitive Advantage by Using Simultaneous Engineering to Integrate Your Engineering, Design, and Manufacturing Resources. CASA/SME AUTOFACT '89 Conference. October 1989. p92.
- Garrett, R.W. : Eight Steps to Simultaneous Engineering. Manufacturing Engineering, Vol.105, No.5, November 1990. pp41-4, 46-7.
- Hall, D. : Concurrent Engineering : Defining terms and Techniques. IEEE Spectrum, Vol. 28, No.7, July 1991. pp24-25.
- Hartley, J.R. : Concurrent Engineering : Shortening Lead Times, Raising Quality, and Lowering Costs. Productivity Press, 1992.
- Hendricks, F. : Understanding the Potential Impact of Simultaneous Engineering on your New Product Development Strategy. Proceedings of the Second South African Concurrent Engineering Symposium, Pretoria, Fedruary 1994. pp1-16.
- Hunter, S.B. : PIM Systems Manage The Information Morass. Machine Design, Vol. 65, No.9, May 28, 1993. p27-30.
- Jo, H. et al. : CE : The Manufacturing Philosophy for the '90s. Computers and Industrial Engineering. Vol.21, No.1-4, 1991. pp35-39.
- Kempfer, L. : Buiding a Team. Machine Design, Vol.65, No.15, July 23, 1993. ppSS4 - SS8.
- Layne, B. : Making Skunkworks Work For You. Midnight Engineering, March-April, 1993. pp57-62.
- LeBrun, J.F. : Cutting Circuit Boards Down to Size. Machine Design, Vol.63, No.6, March 21, 1991. pp130-135.
- Leedy, P.D. : Practical Research : Planning And Design. MacMillan Publishing Company, New York. Fifth Edition, 1993.
- Lewis, J.W. : The CE Testbed : Methodology and Tools for Developing Concurrent Engineering Systems. IEEE Computer Soc. Press. 1990.

- Longust, T.A. : DesignJet Plotter Chassis Design : A Concurrent Engineering Challenge, Hewlett-Packard Journal, December, 1992. pp28-31.
- Mackey, W.A. : Measure the Steps to Success. IEEE Spectrum, Vol. 31, No.6, June 1994. pp23-38.
- Main, J. : Manufacturing the Right Way. Fortune, Vol121, No.11, May 21, 1990. pp54-64.
- Maliniak, L. : Teamwork is the Key to Concurrent Design. Electronics Design, Vol. 39, No.1, 10 Jan, 1991. pp37-9, 42-3, 46, 48, 50.
- Markowitz, M.C. : Concurrent Engineering Journey Starts with the First Steps. EDN Journal, Vol. 36, No. 15, 18 July, 1991. pp110-14.
- Meade, E.K. : Simultaneous Engineering in Action. Production, Vol. 101, No. 10, October 1989. pp68-70.
- Mills, R. : Concurrent Engineering : Alive and Well. CAE, Vol.12, No.8, August, 1993. pp41-44.
- Minnaar_1, S.J. : Concurrent Engineering in South Africa: A Practical Strategy and Support System. Dissertation presented for the Degree of Doctor of Philosophy at the University of Stellenbosch, July 1994. p13.
- Minnaar_2, S.J. : Practical Integration of Configuration Management and Concurrent Engineering. Proceedings of the Second South African Concurrent Engineering Symposium, Pretoria, October 1993. pp 5, 25-39.
- Nickerson, D.P. : Introduction to Concurrent Engineering in Design. IEEE - Electro/90, May 9-11, 1990.
- O'Neal, C. : CE with early supplier involvement : A Cross-Functional Challenge. International Journal of Purchasing & Material Management (JPR), Vol.29, No.2, Spring 1993. pp2-9.
- Osborn, E. : Industrialization, Liberalization and Export Promotion. Nedbank Quarterly Guide to the Economy, Nedbank Economic Unit, November 1992.
- Owen, J. : Concurrent Engineering. Manufacturing Engineering, Vol.109, No.5, November 1992. pp69-73.
- Port,O & Schiller,Z.: A Smarter Way to Manufacture : How Concurrent Engineering can Invigorate American Industry. Business Week, April 30, 1990. pp64-69.

- Rosenblatt_1, A. : Concurrent Engineering Special Report, IEE Spectrum, Vol. 28, No. 7, July 1991. pp22-26.
- Rosenblatt_2, A. : Success Stories in Instrument, Communications - Case History 4 : ITEK Optical Systems. IEEE Spectrum, Vol.28, No.7, July 1991. pp36-37.
- Ruffles, P. : Modelling the Future with CAD. Professional Engineering, April 6, 1994. p8.
- Salzberg, S. : Managing Information for Concurrent Engineering: Challenges and Barriers. Research in Engineering Design, Vol.2, No.1, 1990. pp35-52.
- Shina_1, S.G. : Concurrent Engineering and Design for Manufacture of Electronics Products, Van Nostrand Reinhold, New York, 1991.
- Shina_2, S.G. : Concurrent Engineering : New Rules for World-Class Companies. IEEE Spectrum, Vol. 28, No.7, July 1991. pp22-6.
- Shina_3, S.G. : Successful Implementation of Concurrent Engineering Products and Process, Van Nostrand Reinhold, New York, 1994.
- Siegel, B. : Organizing for a Successful CE Process. Industrial Engineering (INE), Vol.23, No.12, December 1991. pp15-19.
- Smith, K.M. : Concurrent Engineering: The Challenge for the 1990s. Proceedings of the IEEE 1990 National Aerospace and Electronics Conference- NAECON 1990.
- Sprague, R.A. : Concurrent Engineering in Product Development. IEEE Design & Test of Computers, Vol.8, No.1, March 1991. pp6-13.
- Sprow, E.E. : Chrysler's Concurrent Engineering Challenges. Manufacturing Engineering (MFE), Vol.108, No.4. April 1992. pp35-42.
- St. Charles, D. : Don't Toss It Over - Break Down the Walls. Automation, Vol.37, No.6, June 1990. pp68-69.
- Stewart, T.A. : Welcome to the Revolution. Fortune, December 13, 1993. pp32-38.
- Trygg, L. : Concurrent Engineering Practices in Selected Swedish Companies : A Movement or an Activity of the Few. Journal of Product Innovation Management (JPI), Vol.10, No.5, November 1993. pp403-415.
- Turino, J. : Concurrent Engineering : Making It Work Calls for Input from Everyone. IEEE Spectrum, Vol.28, No.7, July 1991. pp30-2.

- Ulerich, P.L. : Tips for Concurrent Engineering. Machine Design, Vol.64, August 20, 1992. pp54-57.
- Vesey, J.T. : Meet The New Competitors: They Think In Terms Of Speed-To-Market. Industrial Engineering, December, 1990. pp20-26.
- Wesley, A.C. : Simultaneous Engineering : Integrating Manufacturing and Design. Society of Manufacturing Engineers (SME), 1990.
- Wheeler, R. : Success Stories in Instrumentation, Communications. IEEE Spectrum, Vol.28, No.7, July 1991. pp32-37.
- Woodruff, D. G. : All Charged Up Over the Electric Car. Business Week, October 21, 1991. p106,108.
- Young, J. : Concurrent Engineering Streamlines the Design Process. Electronics Design, April 12, 1990. p203.
- Zangwill, W.I. : Concurrent Engineering : Concepts and implementation, IEEE Engineering Management Review, Vol.20, No. 4, pp40-52.

BIBLIOGRAPHY

- Anderson, R. : Concurrent Engineering is Evolving from an Industry Goal to Reality : Linking Design and Test. Electronics, August, 1990. pp76-78.
- Anonymous : Mentor and HP Extend Concurrent Engineering to Testing. Electronics, April, 1990. p22.
- Anonymous : Computer Graphics '93 Conference : Preview. Computer Graphics, Vol.4, No.4, October 1993. pp10-13.
- Anonymous : Concurrent Engineering Award Honours Outstanding Manufacturers. Machine Design, Vol.65, No.10, May 28, 1993.
- Anonymous : Taking Off: Boeing. Financial World, Vol.162, No.22, November 9, 1993. pp53-54
- Anonymous : Concurrent Engineering Simplifies Sophisticated Tester. Machine Design, Vol.65, No.20, October 8, 1993. p33
- Anonymous : Chrysler Wins First Annual Machine Design CE Award. Machine Design, Vol.64, No.4, February 20, 1992. pp40-47
- Anonymous : Concurrent Engineering, Global Competitiveness, and Staying Alive : An Industrial Management Roundtable, Part II. Industrial Management, Vol.32, No.5, September/October 1990. pp4-12,16
- Barlow, A. : Computer Improvements Shorten Time to Market. Machine Design, Vol.64, No. 6, March 26, 1992. p159
- Babish, J et al. : Concurrent Engineering. Electronics Progress, Vol.30, No.1, 1990. pp26-32.
- Beckert, B.A. : Concurrent Engineering: Changing the Culture. CAE, Vol.10, No.10, October 1991, pp51-56.
- Beckert, B. : SDRC's New Concurrent Engineering Tools. CAE, Vol.10, No.4, April 1991. p22
- Bergstrom, R.P. : Assembly : Sometimes Great Notions Work. Production, Vol.101, No. 10, October 1989. pp54-58.
- Bond, B : Stereolithography : An Enabling Technology to Concurrent Engineering. Computer Graphics, Vol.4, No.5, October 1993. pp25, 66.

- Bruggere, T : Concurrent Engineering Key to Tenfold Productivity Boost. Computer Design, December 1, 1989. p81.
- Carrabine, L : Concurrent Engineering: Narrowing the Education Gap. CAE, Vol.10, No.10, October 1991. pp90-94.
- Creese, R. et al. : Cost Modeling for Concurrent Engineering. Cost Engineering, Vol.32, No.6, June 1990. pp23-27.
- Cutkosky, M. : PACT : An Experiment in Integrating Concurrent Engineering Systems. Computer, Vol.26, No.1, January 1993. pp.28-36.
- Costello, J. : Concurrent Engineering. Computer Design, January 1, 1991. pp21-23.
- De Castro, J. : Decision Support System Shapes Concurrent Design. Performance Systems, Vol.11, No.4, April 1990. pp44-8.
- Dominach, R.F. : Design Reviews at a Distance. IEEE Spectrum, Vol.31, NO.6, June 1994. pp39-40.
- Donlin, M. : Data Management Tools Tie Frameworks to Concurrent Engineering. Computer Design, 28 April, 1991. pp 28-30.
- Dowlatshahi, S. : A Novel Approach to Product Design and Development in a Concurrent Engineering Environment. Technovation, Vol.13, No.3, April 1993. pp161-176.
- Dunn, J. : Altogether A Better Way. The Engineer. November 8, 1990. p53.
- Dunn, J. : Land Rover on a Voyage of Discovery. The Engineer. December 6, 1990. p35.
- Dwivendi, S.N. : Concurrent Engineering - Why and What? Proceedings. AI, Simulation and Planning in High Autonomy Systems, IEEE Computer Soc. Press, 1990.
- Editorial : Rapid Prototyping: A Strategic Tool In Concurrent Engineering, Industrial Engineering, November 1992, p22.
- Eitzinger, R. : Simultaneous Engineering Speeds Market Entry, Cuts Lead Time for Automated Assembly Machinery. Electrical Manufacturing, Vol.4, No.4, July 1990. pp16-19.
- Foundyller, C. : Finding the Key to CE. CAE, Vol.11, No.10, October 1992. p96.
- Gautschi, T.F. : Exploring Concurrent Engineering. Design News, August 6, 1990.

- Gorman, J. : CE: The Personal Side. CAE, Vol.11, No.10, October 1992. pp92-93.
- Greene, A.H. : CE : Improving Time to Market. Production & Inventory Management Review, Vol.10, No.7, July 1990. pp22-25.
- Gunn, L. : Design-Automation Tools Tackles Projects In Parallel. Electronics Design, April 12, 1990. pp201-204.
- Gunn, L. : Engineering Database Operates On Object-Oriented Programming. Electronics Design, April 12, 1990. pp189-192.
- Hayes, R.H. : Beyond World-Class: The New Manufacturing Strategy. Harvard Business Review, January-February, 1994. pp77-85
- Hopf, S. : Tolls Interact in Design Analyses. IEEE Spectrum, Vol.31, No. 6, June 1994. pp41-43.
- Hurtubise, W.F. : Don't Blown Away By Simultaneous Engineering. Manufacturing Engineering, July, 1990. p168.
- Hutchison, K. : Implementing Concurrent Engineering. High Performance Systems, Vol.11, No.4, April 1990. pp40-3.
- Kempfer, L. : Team Communications. CAE, Vol.12, No.1, January, 1993. p58.
- Krishnaswamy, G. : CE Deployment : An Enhanced Customer Product Approach. Computers & Industrial Engineering (CIE), Vol.23, No.1-4, November, 1992. pp503-506.
- Kuo, W. & Hsu, J. : Update : Simultaneous Engineering Design in Japan. Industrial Engineering, Vol.22, No.10, October, 1990. pp23-26.
- Machlis, S. : Management Changes key to Concurrent Engineering. Design News, September 17, 1990. pp32-37.
- Macilwain, C. : Common Sense in Oriental Philosophy. The Engineer. November 8, 1990. p40.
- Maliniak, L. : Tools Play Only Supporting Role In CE. Electronics Design, February 28, 1991. pp 18-20.
- Mills, R. et al. : Concurrent Engineering: The Future of Product Development. CAE, Vol.10, No.10, October 1991. pp38-46.
- McLoed, J. E. : New Kind Of Engineering Fuels CAD. Electronics, April 1990. pp50-53.

- McKnight, S. : Simultaneous Engineering Saves manufacturers Lead Time, Costs and Frustration. Industrial Engineering, August 1989. pp25-27.
- Poli,C.& Graves,R: Return Your Competitive Edge with Concurrent Engineering. Controls & Systems (PDE), Vol.39, No.4, April 1992. pp28-31.
- Pennell, J.P. : Concurrent Engineering: Practices and Prospects. GLOBECOM '89, IEEE Global Telecommunications Conference and Exhibition, November, 1989.
- Ramana, R. et al. : Computer Supports for Concurrent Engineering. Computer, Vol.26, No.1, January 1993. pp.12-15.
- Soderberg, L. : Engineering Beyond The Stars. Machine Design, October 22, 1992. pp.75-79.
- SAE International Congress and Exposition. Simultaneous Engineering in the Automotive Industry. Ceramic Bulletin, Vol. 68, No. 5, 1989. pp969-970.
- Vasilash, S.G. : Simultaneous Engineering - Management's New Competitiveness Tool. Production, Vol.99, No. 7, July 1987. pp36-41.
- Vasilash, S.G. : How Your Team Can Fly as High as an SR-71. Production, Vol.104, No.2, February 1992. pp62-66.
- Vasilash, G. : CE : Yes, This May Have a Familiar Ring. Production, Vol.103, No.5, May 1991. pp64-67.
- Wade, D. : Database Management for Concurrent Engineering (DBMS). High Performance Systems, Vol.11, No.4, April 1990. pp49, 52, 55-6.
- Walker, R. : Simultaneous Engineering as a Competitive Advantage. Machine Design / Computer-Aided Engineering, October 1990. ppC1-C16.
- Walklet, R. H. : Continuous Improvement and Simultaneous Engineering. Automotive Engineering. Vol. 97, NO.10, October 1989. pp59-63.
- Welch, R. : Information System Eases Concurrent Engineering. Signal, Vol.44, No.8, April 1990. pp67-8.
- Wong, J. et al. : An Integrated Cost Estimating System for CE Environment. Computers & Industrial Engineering, Vol.21, No.1-4, 1991. pp589-593.

- Yang, D.J. : Boeing Knocks Down the Wall Between the Dreamers and the Doers. Business Week (BWE), October 28, 1991. pp120-121.
- Yesersky, P.T. : Concurrent Engineering : Your Strategic Weapon in Today's Jungle. CMA Magazine, Vol. 67, No.6, July/August 1993. pp24-27.
- Ziemke, M. et al. : Don't Be Half-Hearted in Your Efforts to Employ CE. Industrial Engineering, Vol.23, No.2, February 1991. pp45-49.
- Zorpette, G. : Seeking Nuclear Safeguards - Part 1 : How Iraq Reverse-Engineered the Bomb. IEEE Spectrum, Vol.29, No. 4, April, 1992. pp20-24, 63-65.

APPENDIX I

Format of the Primary Questionnaire used for the industrial survey.

Survey on Concurrent Engineering

Dear Sir,

My name is Dhiren Seeruttun and I am conducting a survey for the purpose of a Master's thesis for the department of School of Engineering Management at the University of Cape Town. The survey will investigate the application of Concurrent Engineering (CE) practices in the South African Electronics Industry. This particular questionnaire is mainly intended to test the level of awareness of CE in that industry.

Some of the other common names given to CE are : Simultaneous Engineering, Design for Manufacture, Concurrent Design, Team Design. Consequently, it has also been given different definitions. They all basically imply the following : *"Concurrent Engineering means involving marketing and sales, as well as manufacturing and quality engineers, in the design-engineering stage, getting everyone's input before the design document is finalised."*

I would appreciate it very much if you could answer this questionnaire as best as you can and fax it back to me at your earliest convenience on this number : (021) 7971983.

Thanking you in anticipation for your time and support.

Questions :

Q1) Did you know what Concurrent Engineering (CE) is ? Yes No

- If yes,

- How did you first get to know about it ?

Answer : Read Heard Other :.....

- Since when approximately have you known about it ?

Answer :

- How would you rate your knowledge of it ?

Answer : Poor Good Expert

- Has your company ever embarked on a CE program ? Yes No

Q2) It is said that Concurrent Engineering is a powerful means of achieving competitive edge. It reduces direct labour cost, cycle time, inventory, scrap and rework, warranty, and engineering changes, and thus improves overall competitiveness by getting higher quality products onto the market in less time, and with a lower unit cost.

Now that South Africa is back into the international marketplace, to be competitive in that global market, would you (or your management) consider CE as part of your strategic approach in the future to gain competitiveness in order to compete with world leaders? **Answer:** Yes No

- If yes,

- How soon do you think you might start planning to implement a CE program ?

Answer: In 6 month's time In a year's time After 2 years

- How much resistance do you think you might encounter from top management ?

Answer: None Little resistance Major resistance

- CE necessitates an multi-disciplinary product development team consisting of design, process and manufacturing engineers and also persons from marketing, purchasing and finance departments who are committed to achieving common objectives by working well together; sharing resources and information.

From past experience, could you order the departments, starting with no. 1 as the Most resistant to change to no. 6 as the Least resistant, when it comes to a major change in their way of doing their jobs ?

Answer: (No.1 for Most Resistant to No. 6 for Least Resistant)

R&D Dept.(design engineers) :..... Marketing Dept. :.....

Processing Dept. :..... Purchasing Dept. :.....

Manufacturing Dept. :..... Finance Dept. :.....

- CE also requires a good communication infrastructure with at least, an electronics mail capability, for the sharing of product data and information. How would you describe your computer network system at the moment ?

Answer: Don't have one Limited Capability Flexible & Expandable

- If your answer is NO to Q2 above, then

- How is your company planning to be competitive in the local and global market ?

Answer:

- Considering the South African attitudes towards change and new approach to management, do you personally think that CE can be successfully applied to our electronics manufacturing industry? **Yes** **No**

Q3) Do you know of any company (or any of your local competitor) that has implemented CE or is planning to do so? **Yes** **No**

- If yes, please let me know their name(s) and contact person(s) if possible.

Company Name : Contact Person :

Company Name : Contact Person :

Q4) Depending on your response to this questionnaire, I might need to get some more information from you. I would like to know if it would be possible to send you a secondary questionnaire if need be. **Yes** **No**

Once again, thank you very much for your help.

--- END ---

APPENDIX II

Format of the Secondary Questionnaire used in the industrial survey.

Survey on Concurrent Engineering

Dear Sir,

My name is Dhiren Seeruttun and I am conducting a survey for the purpose of a Master's thesis for the department of School of Engineering Management at the University of Cape Town. The survey will investigate the application of Concurrent Engineering (CE) practices in the South African Electronics Industry. This particular questionnaire is designed under the assumption that your company has already implemented or is busy implementing a CE program.

I would appreciate it very much if you could answer this questionnaire as best as you can and fax it back to me at your earliest convenience on this number : (021) 7971983.

Thanking you in anticipation for your time and support.

Questions :

1. GENERAL

Q1. When did your company first become involved with CE ?

A1.

Q2. What factors drove your company to take on CE ?

A2.....

.....

Q2.1 Was the desire to increase your competitiveness in the marketplace one of the factors? A2.1 : Yes No

Q3. What sorts of improvements did your company hope to achieve in pursuing the CE approach ?

A3.....

.....

Q4. Initially, how committed were top management to the CE approach ?

A4.....
.....

Q4.1 If they were sceptic, how did you convince them to endorse the CE approach ?

A4.1.....
.....

Q5. How did you plan your first CE strategy?

A5.....
.....

Q6. What is the first step in implementing a CE program?

A6.....
.....

Q7. What advise do you have for companies just planning their first steps in CE?

A7.....
.....

2. COMMUNICATION INFRASTRUCTURE & PRODUCT MANAGEMENT

Q8. In order to make CE successful, information needs to be shared all the time. Are you using an off the shelf Product Data Management (PDM) / Product Information Management (PIM) software package or did you tailor make your own application software ?

A8.....
.....

Q9. Are electronic mail capabilities available to each individual ? Yes No

Q10. Are query and online reporting capabilities available to each individual ?
Yes No

Q11. Are managers and product teams automatically and concurrently informed of problems and their status? Yes No

Q12. Do individuals and teams have electronic access to company-wide product development data that include data from customers and third-party vendors? Yes No

Q13. Are customer expectations determined and converted to established, documented customer or marketing requirements? Yes No

Q14. Do you use Quality Function Deployment (QFD) as a means of integrating customer requirements into the product development? Yes No

3. TEAM INTEGRATION AND EMPOWERMENT

Q15. In selecting your product development team(s), which criteria did you use in choosing the members of the team from the different disciplines?

A15.....
.....

Q16. From which disciplines do the members of your team come from?

A16.....
.....

Q17. Depending on the complexity of the product you are developing, how big do you think the number of members in your team should range?

A17.
Simple product : Number of members in the team :
Fairly complex product : Number of members in the team :
Very complex product : Number of members in the team :

Q18. What levels of authority and responsibility are given to the team?

A18.....
.....

Q19. Do representatives from the customer / third party vendors participate in team decisions? Yes No

Q20. Is adequate team effectiveness training provided for the mixed-discipline team members? Yes No

Q21. How often does the team meet over a weekly period ?

A21 . Once Twice More than twice As often as need be

4. YOUR FIRST CE PROJECT

Q22. In what ways does the first CE pilot project differ from projects conducted using old established methods?

A22.....
.....

Q23. When you began implementing CE, what sorts of problems did you run into?

A24.....
.....

Q25. What "word of caution" would you have for companies which are about to embark on a CE program ?

A25.....
.....

Q26. Was your first CE pilot project a success and if so, what improvements did you achieve ?

A26.....
.....

Q27. Once you have established a CE plan, how do you maintain the momentum?

A27.....
.....

Q28. What sort of technology issues will be important to maintain the momentum of CE initiatives?

A28.....
.....

5. BENCHMARKING THE CE PROCESS

Q29. What sorts of activities do you benchmark in your CE effort ?

A29. Please tick the appropriate one(s).

- Cost Targets
- Number of engineering changes after release
- Number of production changes after release
- Market Timing
- Customer Satisfaction
- Comparing with competitors
- Others (please specify) :

Q30. What sort of pitfalls did you encounter in the benchmarking process ?

A30.....
.....

Q31. What technologies do you use to support benchmarking ?

A31.....
.....

6. MEASURING SUCCESS FROM CONCURRENT ENGINEERING

Q32. What were the key measurements you used to determine the success of your CE program?

A32. Please tick the appropriate one(s) :

- Cost of changes made
- Reduction in number of engineering design changes during production
- Time to market
- Productivity Measurement
- Quality of end product
- Customer Satisfaction
- Progress towards eliminating the building and testing of physical prototypes
- Market shares
- Others (please specify) :

Q33. Did you relate the goals of your CE program to measurements of customer satisfaction or to other factors in the marketplace ?

A33.....
.....
.....

Q34. How do you expect to refine your CE measurement process for future projects?

A34.....
.....

7. AT LAST !!

Q35 Would you consider the implementation of CE in your company to be a success and do you think CE can be successfully implemented in S.A?

A35?.....
.....
.....

Q36 If you have any comment / suggestion / advice, please write them below :

A36.....
.....
.....

Depending on your response to this questionnaire, I might need further information or clarification from you. Will it be possible for me to conduct a telephonic interview with you at a later stage ? Yes No

Once again, thank you for your help and good luck with your CE program !

--- END ---

APPENDIX III

Data Analysis of the findings in the primary survey.

Key :

- A :** Does the engineering / program manager of the company know what CE is - (Yes / No)
- B :** How did the manager get to know about CE - (Read / Heard / Lectured)
- C :** Since when did the manager know about CE - (Year)
- D :** How does the manager rate his/her knowledge on the CE concept - (None / Poor / Good / Expert)
- E :** Is the manager's company currently using CE or ever used CE before - (Yes / Partially (Yp) / No)
- F :** Would the manager consider implementing CE to gain competitiveness - (Yes / No)
- G :** How soon might the manager start planning to implement CE in his/her company - (< 6 months / < 12 months / > 24 months)
- H :** How much resistance does the manager think he/she might be encountered from top management (None / Little / Major resistance)
- I :** Which department is Least resistant to change in the company
- J :** Which department is Most resistant to change in the company
- K :** What is the current capability of the computer network system in the company - (Don't have one / Limited / Flexible)
- L :** Does the manager personally think that CE can be successfully applied in the local electronics industry - (Yes / No)

Company	A	B	C	D	E	F	G	H	I	J	K	L
1	Y	Read	14	Good	Yp	-	-	-	-	-	Flex.	Y
2	Y	Lect.	4	Poor	N	Y	< 6	Little	Manf.	R&D	Lim.	Y
3	Y	Read	1	Poor	N	N	-	-	-	-	None	N
4	Y	Read	2.5	Good	Yp	-	-	-	-	-	Flex.	Y
5	Y	Heard	3	Poor	N	Y	<12	Little	Markt	R&D	Lim.	Y
6	Y	Read	1.5	Good	N	Y	<6	None	Manf.	R&D	Flex.	Y
7	N	-	-	None	N	Y	>24	Little	Manf	R&D	Lim.	Y
8	Y	Lect.	5	Good	Yp	-	-	-	-	-	Lim.	Y
9	Y	Heard	1	Good	N	Y	<6	None	Markt	Manf	Flex.	Y
10	Y	Lect.	29	Exper	Yp	-	-	-	-	-	None	Y
11	Y	Heard	4	Poor	N	Y	<6	Little	R&D	Manf	Lim	Y
12	Y	Read	20	Poor	N	Y	<6	Little	Mark	R&D	Flex	Y
13	Y	Read	2	Poor	N	Y	<12	Little	Mark	R&D	Lim	Y
14	Y	Heard	2	Good	N	Y	<6	None	R&D	Manf.	Flex	Y
15	N	-	-	None	N	Y	<6	Little	Manf	R&D	Lim	Y
16	Y	Heard	3	Poor	Yp	-	-	-	-	-	Flex	Y
17	N	-	-	None	N	N	-	-	-	-	None	N
18	Y	Read	1	Poor	N	N	-	-	-	-	None	N

19	N	-	-	None	N	N	-	-	-	-	Lim	N
20	N	-	-	None	N	Y	<12	Little	Mark	R&D	Lim	Y
21	N	-	-	None	N	Y	<6	Little	Mark	Manf	Flex	Y
22	N	-	-	None	N	Y	<12	None	Mark	R&D	Flex	Y
23	N	-	-	None	N	Y	<6	None	Mark	R&D	Lim	Y
24	Y	Read	4	Exper	Y	-	-	-	-	-	Flex	Y
25	Y	Lect.	6	Exper	Yp	-	-	-	-	-	Flex	Y
26	Y	Read	5	Exper	Yp	-	-	-	-	-	Flex	Y
27	Y	Read	5	Exper	Y	-	-	-	-	-	Flex	Y
28	N	-	-	None	N	Y	>24	Little	R&D	Manf.	Lim	Y
29	N	-	-	None	N	Y	<12	Little	Mark	R&D	Lim	Y
30	Y	Read	4	Exper	Y	-	-	-	-	-	Flex	Y
31	Y	Heard	3	Poor	N	Y	>24	Major	Mark	R&D	Lim	Y
32	Y	Read	4-	Poor	N	Y	>24	Little	Manf	R&D	Lim	Y

APPENDIX IV

Performance Metrics for Measuring CE

Design Phase Metrics		
<u>Project/Product</u>	<i>Measures</i>	<i>Definition</i>
Return factor	Return on investment	$\frac{\text{Incremental profit (5 years)}}{\text{Project cost}}$
Design engineering changes	Stability of design	$\frac{\text{Number of engineering changes after GO}}{\text{Engineering change cost}}$
Design iterations	Concurrent design	$\frac{\text{Number of iterations (PCB, mech)}}{\text{Design complexity factors}}$
Staff level	Staffing for success	$\frac{\text{Assigned staff}}{\text{Required staff}}$
Customer visits	Understand customer	$\frac{\text{Number of visits per engineer}}{\text{Number of visits to different customers}}$
Production Phase Metrics		
<u>Product/Process</u>	<i>Measures</i>	<i>Definition</i>
Production readiness	Ramp-up to full production	$\frac{\text{Months of production}}{\% \text{ of mature volume}}$
Design quality	Engineering changes after production release	$\frac{\text{Number of engineering changes to assembly}}{\text{Total number of released assemblies}}$
Production quality	First-time yield	$\frac{\text{First-time yield}}{\text{Mature product yield}}$
Production cost	Labor standards	$\frac{\text{New product standards}}{\text{Mature product standards}}$
Design quality	Field failure rate	$\frac{\text{Failure rate}}{\text{Ks}}$
Design Process Metrics		
<u>Process</u>	<i>Measures</i>	<i>Definition</i>
Cycle time	Process turn around time	Time/process, PCB, sheet metal, etc.
Process trends	Long-term gain	Process parameters versus project time
Input/output	Process efficiency	$\frac{\text{R \& D hours/process}}{\text{R \& D \$ / process}}$
Productivity tools	Investment in tools	$\frac{\text{\$ Investment in tools}}{\text{\$ R \& D budget}}$
People Metrics		
<u>People</u>	<i>Measures</i>	<i>Definition</i>
Performance evaluation	People issues	% on time
Project completion	Job satisfaction	$\frac{\text{Number of projects completed}}{\text{Number of projects started}}$
Training	People investment	Number of hours/engineer
Turnover	Morale	% turnover/year