



Interactive effects of temperature and grazing by seagrass limpets (*Siphonaria compressa* and *Fissurella mutabilis*) on seagrass (*Zostera capensis*)

Christopher T. Waspe

Supervisor: Dr Deena Pillay

02nd March 2015

Minor Dissertation presented in partial fulfilment of the requirement for the degree of Master of Science in Applied Marine Science

Department of Biological Sciences

Marine Research Institute

University of Cape Town

7701 Rondebosch

Cape Town, South Africa

The copyright of this thesis vests in the author. No quotation from it or information derived from it is to be published without full acknowledgement of the source. The thesis is to be used for private study or non-commercial research purposes only.

Published by the University of Cape Town (UCT) in terms of the non-exclusive license granted to UCT by the author.

Table of Contents

List of Figures and Tables	i
Plagiarism Declaration	iii
Acknowledgements	iv
Abstract	v
Interactive effects of temperature and grazing by seagrass limpets (<i>Siphonaria compressa</i> and <i>Fissurella mutabilis</i>) on seagrass (<i>Zostera capensis</i>).....	1
1. Introduction	1
1.1. Climate Change	1
1.2. Temperature change in marine ecosystems.....	3
1.3. Seagrass ecosystems.....	4
1.4. Temperature change and seagrasses in the Western Cape, South Africa.....	9
1.5. Aims and key questions	12
2. Methods and materials.....	14
2.1. Experimental Design	14
2.2. Post-experiment measurements	15
2.3. Data Analysis	16
3. Results.....	18
3.1. Leaf Abundance	18
3.2. Leaf Length and Surface Area	19
3.3. Algal Mass	21
3.4. Leaf Mass	23
3.5. Root mass.....	25
3.6. Grazers	27
4. Discussion.....	28
4.1. Algal fouling	28
4.2. Seagrass leaf morphology	32
5. Conclusion.....	34
References	36

List of Figures and Tables

Figures:

Figure 1: Mean Maximum Yearly Temperature for Langebaan Lagoon over the last 40 years (Lawrence <i>pers data</i> , 2015)	12
Figure 2: Langebaan Lagoon and location of sampling sites * (From Pillay <i>et al.</i> , 2010)	13
Figure 3: Experimental Design - Four mesocosm units with different temperatures and grazer treatments (C=Control, F= <i>Fissurella mutabilis</i> , S= <i>Siphonaria compressa</i>). Arrows indicate water flow.	17
Figure 4: Mean (+ 1SE) leaf deaths (%) between temperature and grazer treatments	18
Figure 5: Mean (+ 1SE) leaf surface area (mm ²) between temperature and grazer treatments	20
Figure 6: Mean (+ 1SE) leaf length (mm) between temperature and grazer treatments	20
Figure 7: Mean (+ 1SE) algae mass (mg/mm ²) between temperature and grazer treatments	22
Figure 8: Mean (+ 1SE) leaf mass (g) between temperature and grazer treatments	24
Figure 9: Mean (+ 1SE) root mass (g) between temperature and grazer treatments	25
Figure 10: Mean (+ 1SE) limpet deaths between temperatures	27
Figure 11: Mean seasonal temperatures for Geelbek and Oesterval sites in Langebaan Lagoon. Measured in 2014 (Lawrence <i>pers data</i> , 2015)	32

Tables:

Table 1: Results of post-hoc tests (Tukey's HSD) for differences in leaf deaths among temperature treatments. P = significance level	19
Table 2: Results of post-hoc tests (Tukey's HSD) test for differences in algal mass (mg/mm ²) among temperature treatments. P = significance level.....	22

Table 3: Results of post-hoc tests (Tukey's HSD) test for differences in algal mass (mg/mm^2) among grazer treatments. P = significance level 23

Table 4: Results of post-hoc tests (Tukey's HSD) test for differences in leaf mass (g) among temperature treatments. P = significance level..... 24

Table 5: Results of post-hoc tests (Tukey's HSD) test for differences in root mass (g) among temperature treatments. P = significance level..... 26

Plagiarism Declaration

I, the undersigned, know the meaning of plagiarism and declare that all of the work in this minor dissertation, save for that which is properly acknowledged, is my own, carried out in the Marine Research Institute in the Department of Biological Sciences, University of Cape Town. It has not previously in its entirety or in part been submitted to any University. Any other sources of information are fully acknowledged.

Date: ...02nd March 2015... Signature:

Christopher Themba Waspe

Acknowledgements

First and foremost I would like to thank my supervisor Deena Pillay who guided me through this project. Through his assistance and expertise I learnt many skills and vastly increased my knowledge. Without him none of this would have been possible. Thanks to the National Research Foundation for providing the necessary funding for this project. Thanks to the various members of the Department of Biological Sciences who assisted me throughout this project. Thanks to George du Plessis who helped in the set-up of the aquarium. Special thanks to Cloverley Lawrence and Martin Emanuel for greatly assisting me behind the computer, in the lab and in the field. I would like to thank the AMS class of 2014/2015 for their friendship and support, especially Ben Brooker and Paul Juby who made this past year as unproductive as they possibly could. Thanks to South African National Parks and the West Coast National Park for their assistance. Finally I would like to thank my family for their continued support.

Abstract

Climate change is a reality. One of the main ecological concerns regarding climate change is the predicted increase in atmospheric and sea temperatures. The latter is expected to rise by roughly 2.5°C by the end of 2050 with dramatic impacts on marine ecosystems predicted around the world. Seagrass ecosystems are a good example of vital ecosystems that are threatened by climate change and other anthropogenic factors. A decline in global seagrass cover of 29% has been estimated over the last century, and at a local level, cover of the seagrass *Zostera capensis* has declined by 38% over the last 50 years in Langebaan Lagoon, with associated losses of invertebrate abundance by 70% in certain areas. Two limpets, *Siphonaria compressa* and *Fissurella mutabilis* depend on *Zostera capensis* for their survival in Langebaan Lagoon, feeding on epiphytic diatoms, filamentous algae and bacteria growing on blades on seagrass. *Siphonaria compressa* occurs exclusively in beds of *Zostera capensis* and is currently listed as critically endangered. Increasing sea temperatures have been found to directly and indirectly affect seagrass growth and survival. Temperature changes influence epiphytic microalgal growth on seagrass blades, thereby limiting light and nutrient availability to seagrasses. Key grazers, however, can potentially limit microalgal growth on seagrasses, but this function is dependant on how they respond to temperature change. Therefore, understanding the effects of temperature on seagrasses and their grazing limpets is vital to seagrass health and ultimately their persistence in marine ecosystems. To quantify the latter, a mesocosm experiment was conducted to assess the interactive effect of temperature changes and grazing by the limpets *S. compressa* and *F. mutabilis* on the seagrass *Z. capensis*. One of the main outcomes of the experiment was that increasing temperatures significantly enhanced algae biomass fouling seagrass leaves. At the same time, limpet feeding significantly decreases algal fouling, especially at higher temperatures. *S. compressa* was significantly more effective at removing algae from the blades of *Z. capensis* than *F. mutabilis*, particularly at higher temperatures. Increasing temperatures and the feedback from grazer presence had no substantial impact on the growth of *Z. capensis* but

significantly influenced the survival of the seagrass blades. Another important result for predicting future effects of temperature rise on seagrass ecosystems was that mortality of *F. mutabilis* was significantly greater than *S. compressa* at higher temperatures. Overall, the study demonstrates that increasing temperatures clearly impacts the dynamics of seagrass ecosystems, either directly by impacting seagrasses or indirectly, by increasing algal fouling. The presence of limpets is also vital in controlling the levels of algae, with *S. compressa* performing more of a beneficial role in keeping blades of seagrass free of fouling. These findings are relevant for the conservation of seagrasses in Langebaan Lagoon, as they indicate the importance of preserving populations of the endangered limpet *S. compressa* in order to maintain healthy functioning seagrass ecosystems under future warming scenarios.

Key words: Temperature rise, seagrass, limpets, epiphytic algae, biotic interactions.

Interactive effects of temperature and grazing by seagrass limpets (*Siphonaria compressa* and *Fissurella mutabilis*) on seagrass (*Zostera capensis*)

1. Introduction

1.1. Climate Change

Since the industrial era, anthropogenic activities have had a great impact on the planet, resulting in the degradation and loss of complex ecosystems around the world (Harley *et al.*, 2006, Doney *et al.*, 2012). Human activities have directly caused the destruction and deterioration of vital ecological systems through increased development, destructive harvesting, mismanagement and pollution. These threats occur globally across multiple ecosystems, leading to losses of biodiversity and functionality and ecosystems which are potentially more susceptible to local climatic and environmental changes (Harley *et al.*, 2006, Morelissen and Harley, 2007, Doney *et al.*, 2012).

Human impacts can operate on natural systems both directly and indirectly. Through mass industrial development and rapid population increases, global climate and environments have been altered (Harley *et al.*, 2006, Morelissen and Harley, 2007, Doney *et al.*, 2012). Due to the growing demand for food and space, massive sections of natural vegetation stands such as forests, have been cleared for industry and agriculture. Natural animal populations have been placed under extreme stress and even forced to extinction through over-harvesting, habitat loss and pollution (Harley *et al.*, 2006, Morelissen and Harley, 2007, Doney *et al.*, 2012). Increases in industrial and population growth have accelerated fossil fuel burning, leading to indirect and direct compositional changes in our atmosphere (Harley *et al.*, 2006, Morelissen and Harley, 2007, Doney *et al.*, 2012).

The combustion of fossil fuels and wide-spread deforestation has combined to increase carbon dioxide levels by 25% since the industrial revolution (Short and Neckles, 1999, Harley *et al.*, 2006, Doney *et al.*, 2012). Concentrations of other 'greenhouse gases' such as methane, nitrous oxide and chlorofluorocarbons (CFCs) have also greatly risen due to anthropogenic activities (Short and Neckles, 1999, Harley *et al.*, 2006, Doney *et al.*, 2012). These gases create a layer around the Earth, absorbing thermal radiation emitted from the Earth and reradiating it back to Earth (Short and Neckles, 1999, Harley *et al.*, 2006, Doney *et al.*, 2012). Along with these changes have been many environmental transformations such as increased storm intensity, alterations in large scale weather phenomena (e.g. El Nino) and rising global temperatures (IPCC, 2001, Harley *et al.*, 2006, Doney *et al.*, 2012). There is much evidence to suggest that coastal marine ecosystems face significant threats posed by anthropogenic climate change (IPCC, 2001, Hiscock *et al.*, 2004, Harley *et al.*, 2006, Doney *et al.*, 2012).

Based on historical climate and oceanographic data, it is predicted that by 2050, average air temperature in coastal environments will be 2°C higher than at present (IPCC, 2001, Hiscock *et al.*, 2004, Morelissen and Harley, 2007, Doney *et al.*, 2012), while sea surface temperatures may be up to 2.5 °C higher, resulting in a greater rate of temperature increase than the Earth has experienced in the past 10 000 years (Hiscock *et al.*, 2004, Morelissen and Harley, 2007, Doney *et al.*, 2012). Changes in climate and weather phenomena have already triggered significant responses in the Earth's biota (Philippart *et al.*, 2011, Doney *et al.*, 2012). These continual changes seriously threaten our marine ecosystems, accelerating degradation and reduced functionality, with significant consequences for human health and welfare (Hiscock *et al.*, 2004, Morelissen and Harley, 2007, Doney *et al.*, 2012).

1.2. Temperature change in marine ecosystems

The potential impacts of climate change on marine ecosystems have been a major concern and focus of study due to their importance around the world in terms of global climate and food security (Fields *et al.*, 1993, Harley *et al.*, 2006, Morelissen and Harley, 2007, Philippart *et al.*, 2011, Doney *et al.*, 2012). Early studies of climate related impacts on marine systems focused on the effects of rising temperature on individual organisms, and to a lesser extent, population level processes (Harley *et al.*, 2006, Morelissen and Harley, 2007, Philippart *et al.*, 2011, Doney *et al.*, 2012). Future changes were predicted using large scale natural phenomena such as the El-Nino Southern Oscillation (ENSO). The general findings and predictions were related to an organism's thermal tolerance and ability to adapt to local climatic changes. The distribution and abundance of species were thought to shift depending on these factors (Harley *et al.*, 2006, Philippart *et al.*, 2011, Doney *et al.*, 2012).

The abundance of literature on climate change impacts on coastal ecosystems has substantially grown since these early studies. While the volume of research has increased, the general focus has remained roughly similar, with the majority of studies concentrating on temperature induced changes in responses of individual organisms. However these responses to temperature changes in both time and space are certainly not as straightforward as once envisioned (Harley *et al.*, 2006, Morelissen and Harley, 2007, Philippart *et al.*, 2011, Doney *et al.*, 2012).

Ecological communities are vastly complex systems with several intricate interactions occurring between components. As such, responses to increasing temperature cannot focus simply on single organisms but should also encompass multiple species and their interactions. The impacts of increasing temperature at community and ecosystem levels depend on how this stressor influences key interactions among dominant species within ecosystems (Sanford, 1999, Harley *et al.*, 2006, Morelissen and Harley, 2007, Philippart *et al.*, 2011, Doney *et al.*, 2012). Due to the complex connections involved between species in ecological systems, consequences of temperature increases are barely understood. The ability to understand and predict community level effects of

increasing temperature therefore depends on understanding how interactions among species are altered by rising temperatures (Sanford, 1999, Harley *et al.*, 2006, Morelissen and Harley, 2007, Philippart *et al.*, 2011, Doney *et al.*, 2012).

1.3. Seagrass ecosystems

Climatic variability, especially increasing temperatures generally pose a significant threat to structurally complex marine ecosystems, but seagrass systems are considered to be one of the most at risk (Thomson *et al.*, 2004, Orth *et al.*, 2006, Morelissen and Harley, 2007, Garthwin *et al.*, 2014). Seagrasses are marine flowering plants (including the widely distributed genera *Zostera*, *Thalassia*, and *Posidonia*) which form some of the most productive ecosystems on earth, rivalling even crops of corn and sugar cane (Thomson *et al.*, 2004, Orth *et al.*, 2006, Wilson *et al.*, 2009, Waycott *et al.*, 2009, Pillay *et al.*, 2010, Garthwin *et al.*, 2014).

1.3.1. Seagrass Biology and Ecology

Seagrasses have developed entirely unique life-history strategies. They have evolved ecological, physiological and morphological traits to survive in completely marine conditions. These traits include internal gas transport, epidermal chloroplasts, aquatic pollination and marine dispersal (Short and Neckles, 1999, Orth *et al.*, 2006, Wilson *et al.*, 2009, Waycott *et al.*, 2009, Pillay *et al.*, 2010, Garthwin *et al.*, 2014). In order for seagrasses to provide oxygen to their roots and rhizomes which grow in highly anoxic sediments with toxic levels of sulphide, they require some of the highest levels of light of any plant group worldwide. They also require high light levels to support large amounts of non-photosynthetic tissue (Terrados *et al.*, 1999, Orth *et al.*, 2006, Koch *et al.*, 2007).

These extremely high light requirements mean that seagrasses are heavily responsive to any changes in the local environment that alter water clarity.

Seagrasses are structurally complex ecosystems that can exist as continuous beds filling hundreds of square meters or as a mosaic of small patches interspersed amongst unvegetated sand-flats, thereby enhancing local habitat heterogeneity. Furthermore, seagrass meadows provide high-value ecosystem services such as (1) supporting commercial fisheries worth as much as R40000 ha per year, (2) sustaining local subsistence fisheries that support entire communities, (3) nutrient cycling, (4) sediment stabilization, and (5) sequestration of carbon on global scales (Short and Neckles, 1999, Thomson *et al.*, 2004, Orth *et al.*, 2006, Wilson *et al.*, 2009, Waycott *et al.*, 2009, Pillay *et al.*, 2010, Garthwin *et al.*, 2014). Seagrasses sustain fisheries and enhance local biodiversity primarily by serving as feeding and nursery habitats for commercially and recreationally important invertebrates and vertebrates including megaherbivores such as manatees, dugongs, and turtles (Ter Morshuizen and Whitfield, 1994, Thomson *et al.*, 2004, Orth *et al.*, 2006, Morelissen and Harley, 2007, Garthwin *et al.*, 2014). Seagrass meadows are hotspots for carbon sequestration and some of the carbon filled sediment is even exported to the deep sea which is extremely food-limited (Shuchanek *et al.*, 1985, Duarte *et al.*, 2005, Garthwin *et al.*, 2014).

Seagrasses provide regulatory services for pelagic ecosystems, modify their physical and chemical environments and reduce levels of suspended sediments, chlorophyll-a and nutrients. Their root-rhizome systems bind and stabilize bottom sediments and their leaf canopies improve water quality through filtration of suspended matter such as organic and inorganic nutrients (Ter Morshuizen and Whitfield, 1994, Short and Neckles, 1999, Orth *et al.*, 2006, Wilson *et al.*, 2009, Waycott *et al.*, 2009, Pillay *et al.*, 2010, Garthwin *et al.*, 2014). Through these activities, seagrasses act as vital ecosystem engineers that provide nutrient-rich, sheltered habitats, enhance biomass, richness and abundance of fauna and flora and ultimately provide unique habitats relative to the unvegetated sand-flats (Ter Morshuizen and Whitfield, 1994, Short and Neckles, 1999, Orth *et al.*, 2006, Wilson *et al.*, 2009, Waycott *et al.*, 2009, Pillay *et al.*, 2010, Garthwin *et al.*, 2014).

Seagrass meadows are extremely sensitive to environmental perturbations, and are declining around the world. Recent studies have shown a 29% loss of global seagrass cover has occurred over the last century (Thomson *et al.*, 2004, Orth *et al.*, 2006, Wilson *et al.*, 2009, Garthwin *et al.*, 2014). This rate of loss is similar to those of mangroves, coral reefs and even tropical rainforests, making seagrass ecosystems one of the most threatened on the planet (Thomson *et al.*, 2004, Orth *et al.*, 2006, Wilson *et al.*, 2009, Garthwin *et al.*, 2014). Regional losses of seagrasses are associated with numerous ecosystem-level effects such as losses of waterfowl populations, the collapse of fisheries (e.g. collapse of a scallop fishery in North Atlantic) and the extinction of a seagrass specialist, the limpet *Lottia alveus* (Carlton *et al.*, 1991, Thomson *et al.*, 2004, Orth *et al.*, 2006, Garthwin *et al.*, 2014). Shifts in seagrass abundance and distribution can therefore signal changing environmental conditions.

1.3.2. Temperature effects on seagrasses

Temperature changes can alter seagrass distribution and productivity (Thomson *et al.*, 2004, Orth *et al.*, 2006, Morelissen and Harley, 2007, Wilson *et al.*, 2009, Garthwin *et al.*, 2014), with parallel changes occurring in local and regional biota, geomorphology and biogeochemical cycles. Such effects can also disrupt important linkages between seagrass communities and other vital ecosystems, resulting in long lasting impacts greater than simply the individual effects of local scale losses of the seagrass. Such linkages are the result of the proximity of seagrasses to other critical habitats such as salt marshes, mangroves and coral reefs (Beck *et al.*, 2001, Thomson *et al.*, 2004, Orth *et al.*, 2006, Morelissen and Harley, 2007, Garthwin *et al.*, 2014), which allows for trophic transfers and cross-habitat utilization for many fish and invertebrate species. This energy exchange can be essential in maintaining the abundance of species in habitats outside of seagrass ecosystems but which are dependent on seagrasses for trophic subsidies (Thomson *et al.*, 2004, Valentine and Heck, 2005, Orth *et al.*, 2006, Morelissen and Harley, 2007, Garthwin *et al.*, 2014).

While temperature variation related to climate change has a clear influence on seagrass (Thomson *et al.*, 2004, Orth *et al.*, 2006, Wilson *et al.*, 2009, Garthwin *et al.*, 2014), its impacts vary in scale and magnitude. Increasing water temperatures ultimately may cause shifts in seasonal and geographic patterns of species abundance and distribution through effects on seagrass metabolism and maintenance of a positive carbon balance (Short and Neckles, 1999, Thomson *et al.*, 2004, Orth *et al.*, 2006, Wilson *et al.*, 2009, Morelissen and Harley, 2007, Garthwin *et al.*, 2014).

Increasing water temperatures can have direct and indirect impacts on seagrasses. Direct impacts are species-specific, being dependent on thermal tolerances and optimum temperatures required for photosynthesis, respiration, and growth. For example, it has been shown that increasing temperatures results in increased respiration rates relative to photosynthetic rates in the seagrass *Zostera marina* (Short and Neckles, 1999, Nejrup *et al.*, 2008), leading to a decrease in the photosynthesis-to-respiration ratio (P: R) and a decrease in seasonal growth. A similar trend is shown for the Mediterranean seagrass *Cymodocea nodosa*, with elevated oxygen production and respiration and no optimum seasonal growth with rising temperatures (Short and Neckles, 1999). Extreme water temperatures have been shown to negatively affect the physiology of *Zostera marina*, with reductions in photosynthetic rate at very low temperatures (5°C) and increased mortality and lowered photosynthetic and growth rates at higher temperatures (25 °C-30°C). It appears that the ideal water temperature lies between 10°C and 20 °C for *Z. marina* (Nejrup and Pedersen, 2008).

In general, warm water species such as *C. nodosa* increase their photosynthesis and respiration over a wide range of temperatures, while the more temperate species such as *Z. marina* and *Heterozostera tasmanica* have a photosynthetic optimum below seasonal maximum temperatures (Short and Neckles, 1999, Nejrup and Pedersen, 2008). Other than the P:R ratio, shifts in plant growth can be affected by other factors impacted by increasing temperatures such as root to shoot ratio, nutrient uptake and enzyme-mediated processes (Short and Neckles, 1999, Nejrup and Pedersen, 2008). Populations which grow in locations where the temperature is above the optimum

for growth or near the upper limit of their thermal tolerance are in danger to increasing temperatures. Productivity and distribution are decreased when there is an annual increase in temperatures pushing the population beyond its limit to survive. Such environmental stress results in a reduction in its overall distribution in summer months (Short and Neckles, 1999, Nejrup and Pedersen, 2008).

It has also been recorded that flowering and seed germination can be influenced by temperature changes in some seagrass species (Short and Neckles, 1999, Nejrup and Pedersen, 2008). For example, seed germination for *Ruppia* sp., *Z. marina* and *Z. noltii* significantly increase with increasing temperatures up to 30°C. However, other studies found no significant temperature effect on the seed germination of these species. Such conflicting results indicate a need for further research on context dependencies that influence the temperature-germination relationship in these seagrass species. For example, temperature interaction with other factors such as salinity may influence seed germination of seagrass. Some species such as *C. nodosa* and *Z. capricorni* require low temperatures for seed germination if the local salinity is high (Short and Neckles, 1999, Nejrup and Pedersen, 2008).

Apart from understanding direct and indirect effects of temperature on seagrass physiology, predicting ecosystem responses to climate change, also requires an understanding of how abiotic changes influence interspecific interactions and the feedbacks generated from the latter. For example, thermal conditions influence the strength of biological interactions such as predation, competition, and facilitation (Sanford, 1999, Leonard, 2000, Morelissen and Harley, 2007, Garthwin *et al.*, 2014). Given the complex connections prevalent in ecosystems, changing thermal conditions may not only alter individual species, but also the interactions that occur between them, which ultimately determine ecosystem functioning. Seagrass ecosystems are composed of the seagrasses themselves and a diverse suite of species living on the plants. Microalgae grow attached to seagrass blades, with macroalgal forms sometimes growing intermingled. Several grazing species feed on this algal layer, including obligate seagrass fauna that live on leaves, as well as pelagic grazing species

(shrimps and fish) (Thomson *et al.*, 2004, Orth *et al.*, 2006, Morelissen and Harley, 2007, Garthwin *et al.*, 2014).

In order to understand effects of increasing temperature on seagrasses, it is important therefore to quantify responses of key components of the system; testing seagrass responses alone is an oversimplification of the problem. Seagrass performance is often linked to the amount of algae present on leaves; under some conditions, seagrasses can become completely fouled by algae, leading to the smothering of plants and starvation of nutrients and light (Thomson *et al.*, 2004, Orth *et al.*, 2006, Morelissen and Harley, 2007, Garthwin *et al.*, 2014). However, levels of fouling can be regulated by grazers, which positively feed back to plants (improved physiological performance). However, temperature can influence both processes (fouling and herbivory) whilst simultaneously impacting seagrass physiology (Short and Neckles, 1999, Harley, 2003, Allison, 2004, Keser *et al.*, 2005, Morelissen and Harley, 2007, Wilson *et al.*, 2009, Garthwin *et al.*, 2014).

1.4. Temperature change and seagrasses in the Western Cape, South Africa

Langebaan Lagoon is part of a marine reserve on the West Coast of South Africa (Fig. 2). The loss of seagrasses (*Zostera capensis*) has been reported in the lagoon along with ecological effects of this loss (Pillay *et al.*, 2010). *Z. capensis* is limited to intertidal sandflats in the lagoon (Angel *et al.*, 2005, Pillay *et al.*, 2010) and functions as a vital ecosystem engineer. It has been estimated that coverage of *Z. capensis* coverage in Langebaan Lagoon has decreased by 38% over the last 5 decades (Pillay *et al.*, 2010); this decline is consistent with losses of seagrass globally (Short and Neckles, 1999, Angel *et al.*, 2005, Wilson *et al.*, 2009). General factors have been invoked to explain declines in seagrass in Langebaan Lagoon (e.g. disturbance, pollution, etc); however, the precise mechanisms responsible for driving losses remain obscure.

While the exact reasons for seagrass loss in Langebaan Lagoon remain unknown, the repercussions of these losses are notable, especially considering that seagrasses are such vital

components of ecosystems with connections to multiple trophic levels (Thomson *et al.*, 2004, Pillay *et al.*, 2010, Garthwin *et al.*, 2014). Following the decline in seagrasses, invertebrate communities were transformed within selected areas in Langebaan Lagoon, with a decrease in invertebrate richness by up to 50% and abundance by up to 70% (Pillay *et al.*, 2010). Many of the species which declined are associated either exclusively or predominantly with *Z. capensis* (Pillay *et al.*, 2010).

The most noteworthy outcome of seagrass declines in Langebaan Lagoon from a conservation point of view was the near extinction of the limpet *Siphonaria compressa* at some sites (Pillay *et al.*, 2010). *S. compressa* is the smallest species of the genus, reaching shell lengths of 3–5 mm (Allanson and Herbet, 2005, Angel *et al.*, 2006) and is currently listed as critically endangered by the International Union for the Conservation of Nature (IUCN). Some evidence suggests that *S. compressa* was at one time more widely distributed in South Africa, but for almost 50 years since its description, it was known only from Langebaan Lagoon on the West Coast of South Africa (Allanson and Herbet, 2005, Angel *et al.*, 2006). Within Langebaan Lagoon, *S. compressa* occurs almost exclusively in the Geelbek region at the southern end of the Lagoon (Fig. 2) (Allanson and Herbet, 2005, Angel *et al.*, 2006). *S. compressa* has recently been discovered at another location 600km east of Langebaan Lagoon at the Knysna Estuary on the South Coast (Allanson and Herbet, 2005, Angel *et al.*, 2006). In addition to its restricted geographic range, *S. compressa* also has extremely narrow habitat requirements, being recorded only on blades of the seagrass *Z. capensis*, where it feeds on epiphytic diatoms, filamentous algae and bacteria (Short and Neckles, 1999, Wilson *et al.*, 2009, Pillay *et al.*, 2010). The conservation of this limpet is thus very closely linked to the conservation and management of the seagrass communities in Langebaan Lagoon.

Even though there is such danger to the existence of this endangered limpet, there is limited knowledge on *S. compressa* and the role it plays in seagrass ecosystems. Only recently has the reproduction and growth of *S. compressa* been documented. Allanson and Msizi (2010) focused on the Knysna population, performing observations to assess larval development, growth, fecundity, mating activity and field measurements for the structure of the natural population. *S. compressa*

appear to have the ability to restore their numbers quickly as they have rapid growth rates and a high frequency of spawning (Allanson and Msizi, 2010).

As *S. compressa* has an extremely limited range, it is important to understand the reasons for this. Understanding the biology of rare species and the factors that predispose these species to extinction are paramount to conservation practices (Chapman, 1999, Wilson *et al.*, 2010). It appears that salinity may have a strong influence on its range (Angel *et al.*, 2006, Wilson *et al.*, 2010), with *S. compressa* having a very low tolerance to low salinities and flooding. Langebaan Lagoon is marine-dominated system with very little freshwater input; therefore salinities tend to remain fairly close to that of seawater. This low tolerance shown by *S. compressa* to hyposaline conditions places a significant restriction on its distribution (Wilson *et al.*, 2010).

Another limpet species which is closely linked to *Z. capensis* in Langebaan Lagoon is the Cape keyhole limpet, *Fissurella mutabilis*. This limpet species virtually disappeared from certain parts of Langebaan Lagoon where seagrasses have been lost (Pillay *et al.*, 2010). *F. mutabilis* is not present in Geelbek where *S. compressa* is predominant, but occurs predominantly in the Oesterwal region (Fig. 2) (Angel *et al.*, 2006). *Fissurella mutabilis* is not an obligate seagrass limpet like *S. compressa* but still requires the presence of the seagrass *Z. capensis* for feeding and refuge in the lagoon (Pillay *et al.*, 2010). It is also found in rocky crevices and amongst other aquatic plants. There is very little information on *F. mutabilis* as it is almost completely unstudied. Known studies revolve around the role of *F. mutabilis* in aquacultural scenarios, focusing on the control of this species (Hansen *et al.*, 2006).

Climate change, especially rising temperatures, could be an important factor responsible for the demise of seagrasses in Langebaan Lagoon either directly or indirectly. Long-term weather data indicate a warming trend for Langebaan Lagoon over the last 40 years (Fig. 1); it is therefore vital for the management on conservation of seagrasses in the system that direct and indirect effects of increasing temperatures on seagrass ecosystems be quantified.

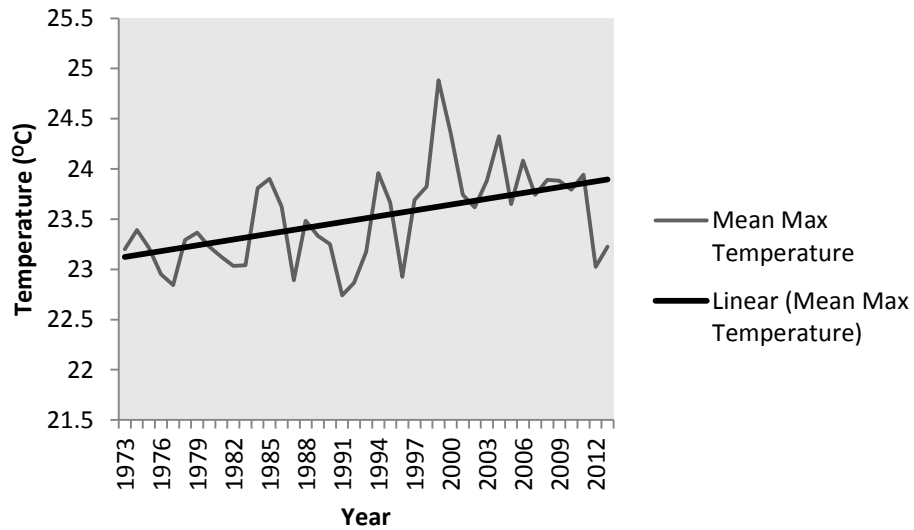

Figure 1: Mean Maximum Yearly Temperature for Langebaan Lagoon over the last 40 years (Lawrence *pers data*, 2015)

1.5. Aims and key questions

The broad aims of the study are to experimentally test the interactive effects of temperatures and grazing by the limpets, *S. compressa* and *F. mutabilis* on the seagrass *Z. capensis*.

The following hypotheses will be tested:

- 1. Increasing temperatures will enhance levels of algae fouling on seagrasses, given the reported ability of algae to proliferate faster under high temperature conditions.
- 2. Grazing by limpets will reduce microalgal fouling of seagrasses, especially under high temperatures
- 3. Given that the limpet *S. compressa* is a seagrass specialist it will more effective in limiting fouling of seagrasses than *F. mutabilis*.

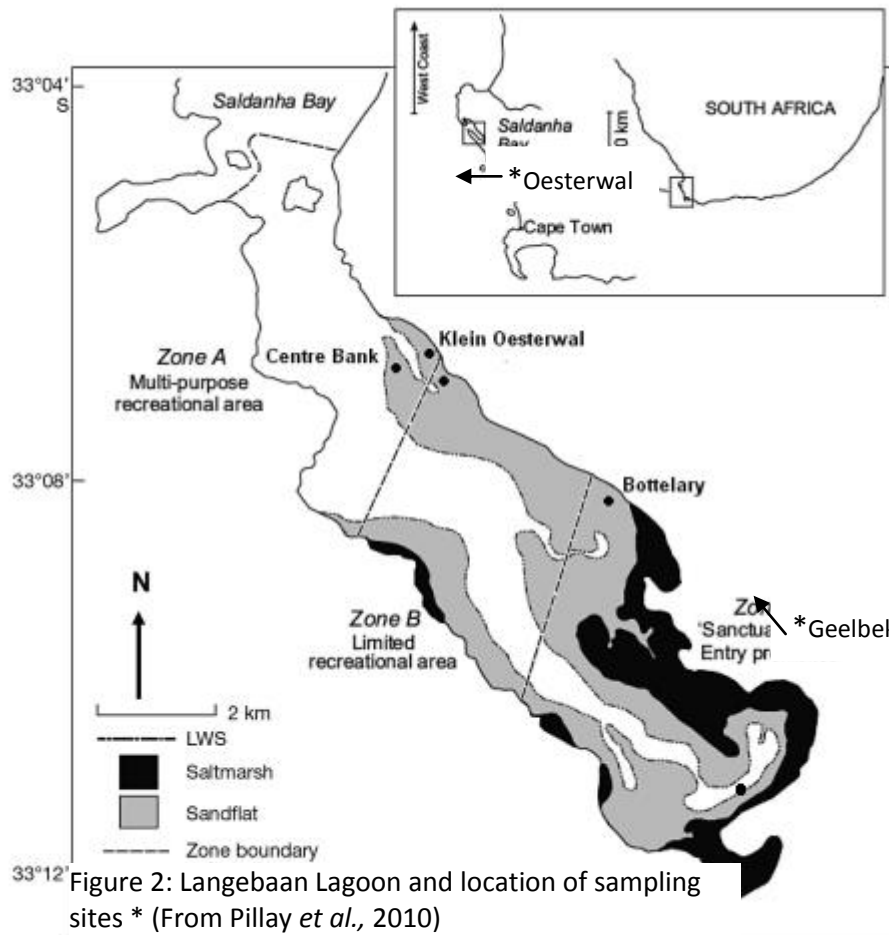

Figure 2: Langebaan Lagoon and location of sampling sites * (From Pillay *et al.*, 2010)

2. Methods and materials

A mesocosm experiment was undertaken to quantify the interactive effects of temperature and grazer presence on seagrass condition and algae growth. Seagrass and limpets that were used in the experiment were collected from Langebaan Lagoon in the West Coast National Park (Fig. 2). *Zostera capensis* and *Fissurella mutabilis* was collected from Oesterwal while *Siphonaria compressa* was collected from Geelbek. Prior to commencing the experiment, all visible grazers on seagrasses and sediment were removed and epiphytic algae delicately scraped off each leaf with the blunt end of a knife (Nejrup and Pedersen 2008). Seagrass density per pot was quantified and limpets added according to treatment designations (details given below).

2.1. Experimental Design

The design used in the experiment is illustrated in Figure 3 and based on Nejrup and Pedersen (2008) and Eklöf *et al.*, (2012). Seawater was transferred into four header tanks (120L), each of which were individually aerated and heated to 4 temperatures, corresponding to the designated temperature treatments used for the experiment (18°C, 22°C, 26°C and 30°C). The latter treatments were based on temperature ranges collected in seagrass beds in Langebaan Lagoon over a year in 2010. Water temperatures were initially at 18°C when seagrass cores with grazers were added. Water was then brought to the desired temperature over a three day period to allow for acclimation. Water was pumped (Atman PH-2500 submersible pump) from each of the four header tanks into three interconnected 80L tanks (replicates for each temperature treatment) with regulating valves to maintain constant flow between tanks.

Connected to each array of three replicate tanks was a fourth 80L tank which collected surplus water from each array, and was then pumped (Atman PH-2500 submersible pump) back into the

header tank. This design created a re-circulation system allowing constant water flow between tanks. The flow rate was kept constant and checked daily (Nejrup and Pedersen 2008, Eklöf *et al.*, 2012). The four temperature treatments were maintained by placing heaters (300W Eheim Jager) in each of the four header tanks. Water temperatures were measured daily to ensure consistency.

Within each 80L mesocosm (excluding the overflow tanks) there were three grazer treatments: (1) a control with seagrass by no grazers, (2) seagrass with *Fissurella mutabilis* (2 per seagrass core) and (3) seagrass with *Siphonaria compressa* (5 per seagrass core). Grazer densities used in the experiment were based on *in situ* limpet densities measured during four surveys of seagrass beds in Langebaan Lagoon in 2010. Grazers were monitored daily to ensure constant numbers were maintained. Any additions to grazer numbers through births were removed. In cases of limpet deaths, new limpets were added to ensure that grazer densities were maintained. All mortalities were recorded. In total, grazer treatments were replicated three times (Fig. 3). All seagrasses were contained in plant pots (top diameter = 13cm, bottom diameter = 10.8cm, depth = 10.8cm, capacity = 1 litre). Osram Lumilux Cool White 58 Watt artificial lighting was used to provide controlled lighting for mesocosms on a 12 hour day/night schedule. Salinity, nutrient levels, pH, O₂ and chl-*a* were tested throughout the experiment to ensure constant levels (Nejrup and Pedersen 2008, Eklöf *et al.*, 2012). Water in each system was changed weekly to prevent build-up of unwanted nutrients. This involved preparation of 120L of seawater at the required temperatures and replacing “old” water with fresh preparations. The experiment was conducted over a five week period after which time the seagrass was removed from the mesocosms and further post experiment analysis performed.

2.2. Post-experiment measurements

Ten leaf samples were randomly chosen per plant pot and the length and width of each leaf was measured. For width, three measurements (base, middle and top) were averaged. These measures

were used to calculate the surface area of each leaf (Short and Duarte, 2001). The algae present on each of the 10 leaf samples were scrapped into labelled, pre-weighed containers and dried for 12 hours at 60°C (Kendrik and Laverty, 2001, Nejrup and Pedersen 2008, Eklöf *et al.*, 2012). All leaves (including those chosen for area measurements) from each plant were cut at the base, cleaned of all bio-matter, placed in pre-weighed containers and dried for 12 hours at 60°C to provide an estimate of above-ground dry mass per pot (Nejrup and Pedersen 2008, Eklöf *et al.*, 2012). Similarly, the roots contained in each pot were delicately rinsed, placed in pre-weighed containers and dried for 12 hours at 60°C to provide an estimate of below-ground dry mass per pot (Nejrup and Pedersen 2008, Eklöf *et al.*, 2012).

2.3. Data Analysis

Statistical analyses of the data were performed using the statistical program R. Two-way analysis of variance (Two-way ANOVA) was used to test the main and interactive effects of the treatments on the response variables. Data normality and homogeneity tests were assessed using Shapiro-Wilks tests and linear regression model validation test such as qq plots and residual plots. All data displayed normal distributions and homogenous variances except for algal mass data and limpet death data. These data were normalised using Box-Cox power transformations.

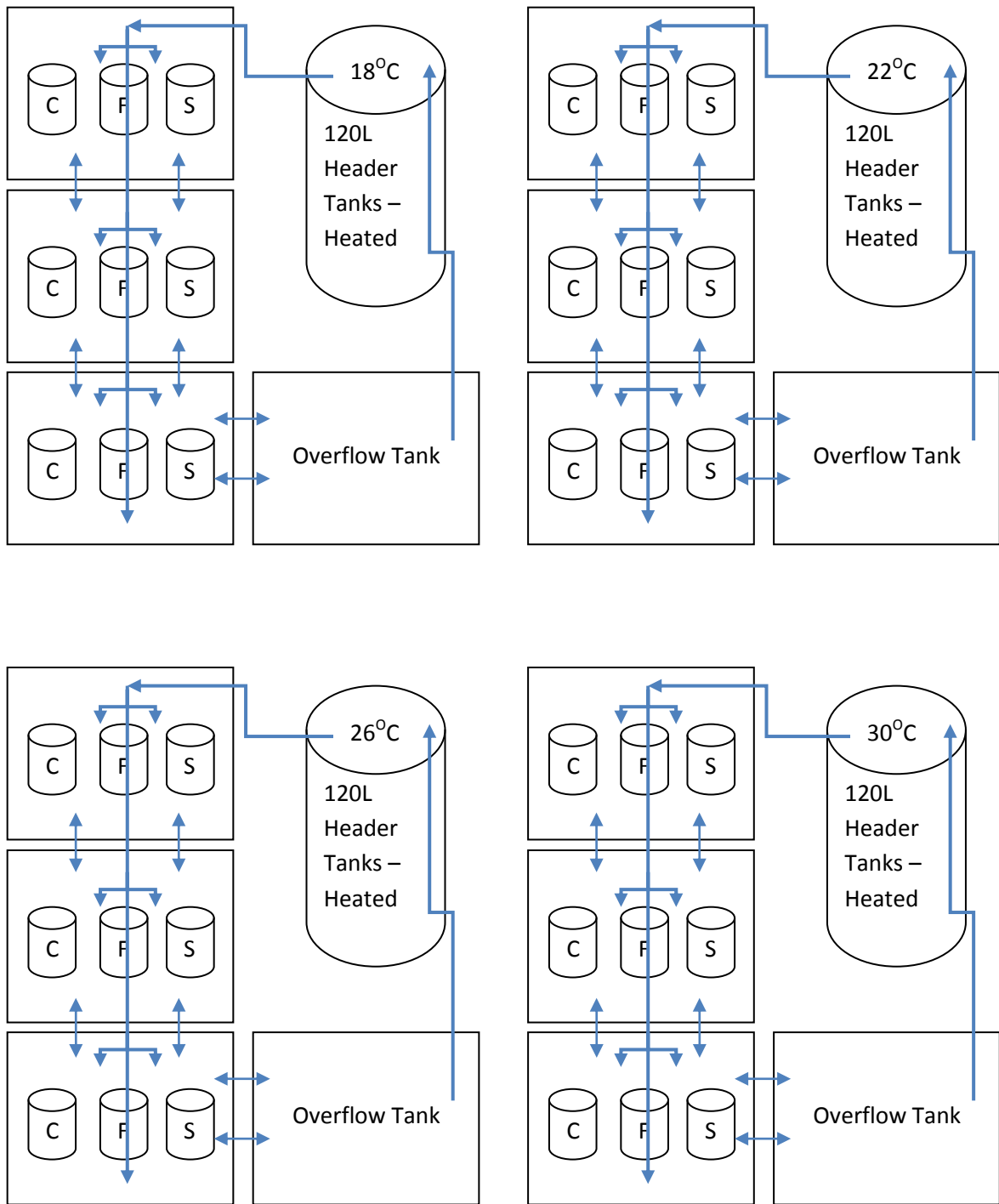

Figure 3: Experimental Design - Four mesocosm units with different temperatures and grazer treatments (C=Control, F=*Fissurella mutabilis*, S=*Siphonaria compressa*). Arrows indicate water flow.

3. Results

3.1. Leaf Abundance

There was a significant difference in percentage leaf deaths between temperatures (ANOVA $df=3$, $F=6.540$, $p<0.05$), but not between grazer treatments (ANOVA $df=2$, $F=0.146$, $p>0.05$). There was also no significant interactive effects of temperature and grazing on leaf deaths (ANOVA $df=6$, $F=1.332$, $p>0.05$). In terms of temperature effects, differences in leaf deaths were greatest between 30°C than 22°C and 18°C (Table 1), with deaths generally being greatest at 30°C.

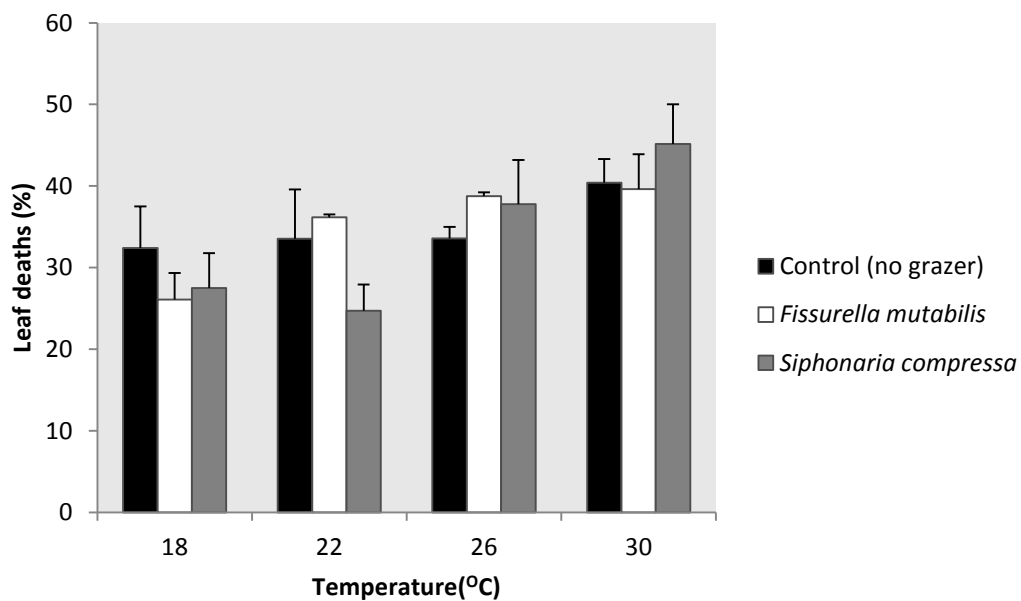

Figure 4: Mean (+ 1SE) leaf deaths (%) between temperature and grazer treatments

Table 1: Results of post-hoc tests (Tukey's HSD) for differences in leaf deaths among temperature treatments. P = significance level

Temperature Treatment	Mean Difference	P
18-22	2.8	0.82
18-26	8.1	0.08
18-30	13.1	<0.05
22-26	5.2	0.38
22-30	10.2	<0.05
26-30	5.1	0.41

3.2. Leaf Length and Surface Area

There was no significant effect of temperature (ANOVA df=3, F=0.905, p>0.05) and grazer (ANOVA df=2, F=0.092, p>0.05) treatments on seagrass leaf lengths. However the interaction between temperature and grazing did significantly impact leaf length (ANOVA df=6, F=2.605, p<0.05). The significant differences lay within the *Fissurella mutabilis* treatment, with seagrasses in the 22°C treatment having significantly longer leaves than those at 26°C (Tukey's HSD post hoc test, Diff=35.7, p<0.05) and 30°C (Tukey's HSD post hoc test, Diff=34.6, p<0.05).

There was no significant difference in surface area of seagrass leaves between the different temperature (ANOVA df=3, F=0.299, p>0.05) or grazer treatments (ANOVA df=2, F=0.216, p>0.05). The interaction between temperature and grazer treatments significantly affected surface area of leaves of plants (ANOVA df=6, F=2.743, p<0.05). The most obvious difference lay within the *Fissurella mutabilis* treatment at 22°C in which leaf surface area was greater than at 26 °C (Tukey's HSD post hoc test, Diff=119.2, p=0.06).

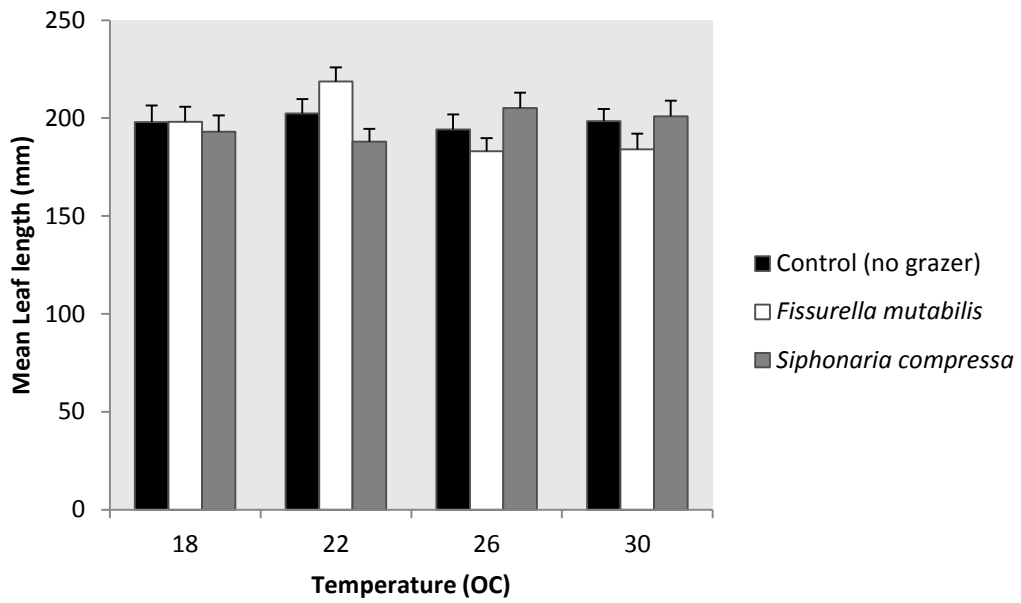

Figure 6: Mean (+ 1SE) leaf length (mm) between temperature and grazer treatments

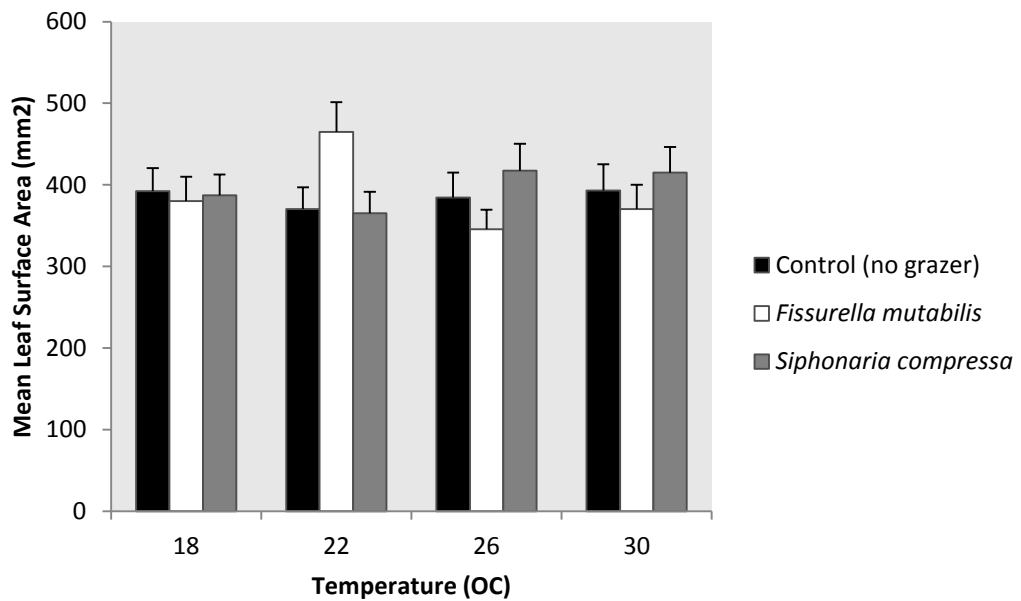

Figure 5: Mean (+ 1SE) leaf surface area (mm²) between temperature and grazer treatments

3.3. Algal Mass

There was a significant difference in algal biomass present on seagrass blades at different temperatures (Fig 7; ANOVA df=3, F=161.18, p<0.001). In general, algal biomass increased with rising temperatures (Fig. 7), with all pairwise comparisons among temperature treatments being significantly different (Table 2). The presence of grazers also had a significant impact on algal biomass on seagrass blades (ANOVA df=2, F=43.41, p<0.001), with algal biomass being different among all grazer treatments (Table 3). Control treatments had significantly more algae than the plants with grazers present, but in the presence of grazers, algal biomass was greater in the presence of *F. mutabilis* than the presence of *S. compressa* (Table 3, Fig. 7).

The interaction between temperature and grazer presence significantly impacted the amount of algae present on the leaves (ANOVA df=6, F=14.86, p<0.001). Among seagrasses subjected to 18°C and 22°C, grazers had no significant impact on the amount of algal fouling. Within the 26°C treatment control treatments had significantly more algae than plants with grazers present (Tukey's HSD post hoc test, Diff=1.3, p<<0.05) and algal biomass was significantly greater in the presence of *F. mutabilis* than the presence of *S. compressa* (Tukey's HSD post hoc test, Diff=-0.5, p<<0.05). At 30°C there was no statistical difference between the algal presence on control seagrasses and those with *F. mutabilis* (Tukey's HSD post hoc test, Diff=-0.2 p=0.6). Plants with *S. compressa* had significantly less algae than the controls and plants with *F. mutabilis* (Tukey's HSD post hoc test, Diff=-0.4, p<0.05).

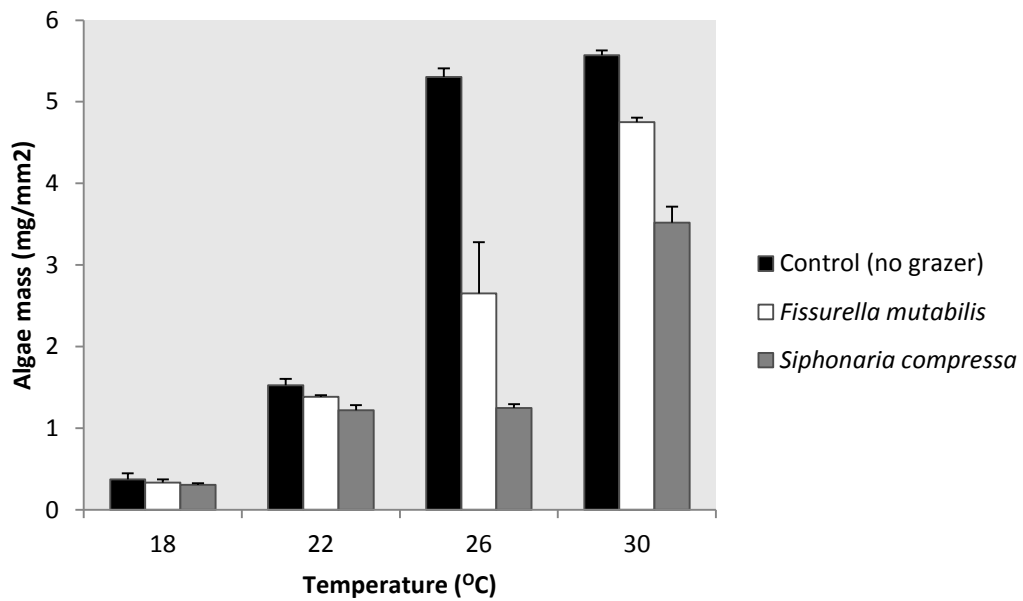

Figure 7: Mean (+ 1SE) algae mass (mg/mm²) between temperature and grazer treatments

Table 2: Results of post-hoc tests (Tukey's HSD) test for differences in algal mass (mg/mm²) among temperature treatments. P = significance level

Temperature Treatment	Mean Difference	P
18-22	0.6	<0.001
18-26	1.2	<0.001
18-30	1.7	<0.001
22-26	0.6	<0.001
22-30	1.1	<0.001
26-30	0.5	<0.001

Table 3: Results of post-hoc tests (Tukey's HSD) test for differences in algal mass (mg/mm²) among grazer treatments. P = significance level

Grazer Treatment	Mean Difference	P
Control- <i>Fissurella mutabilis</i>	-0.3	<0.001
Control- <i>Siphonaria compressa</i>	-0.5	<0.001
<i>Fissurella mutabilis</i> - <i>Siphonaria compressa</i>	-0.2	<0.001

3.4. Leaf Mass

The different grazer treatments (ANOVA df=2, F=0.15, p>0.05) did not to have any significant impact on the leaf mass of the various plants. Similarly, the interaction between grazer and temperature treatments did not influence seagrass leaf mass (ANOVA df=6, F=0.69, p>0.05). The different temperature treatments had a significant impact on the leaf mass of the seagrasses (ANOVA df=3, F=7.91, p<0.05). Leaf mass at 26°C was significantly greater than those at 18°C, 22°C and 30°C.

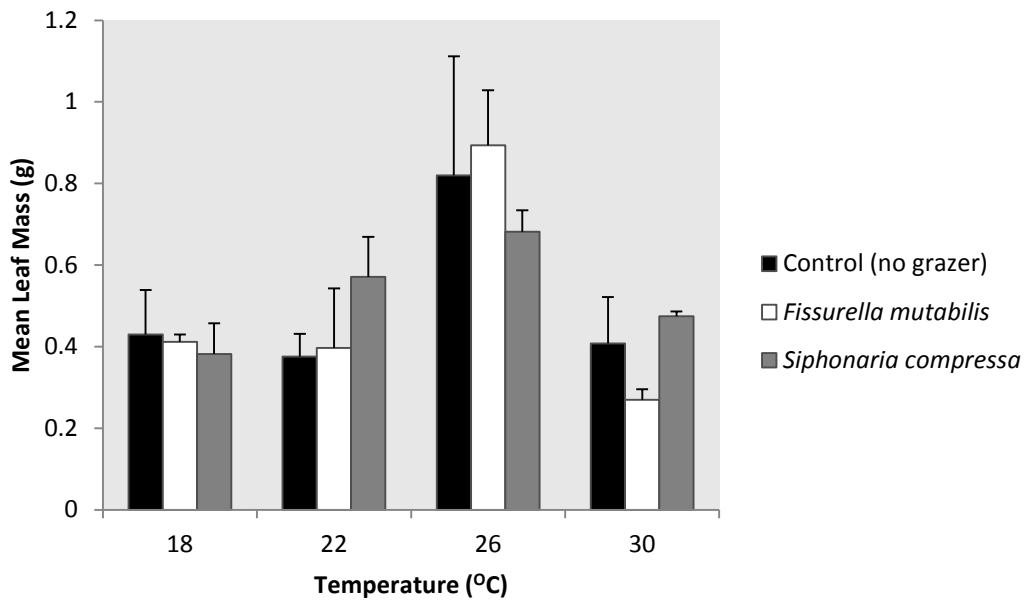

Figure 8: Mean (+ 1SE) leaf mass (g) between temperature and grazer treatments

Table 4: Results of post-hoc tests (Tukey's HSD) test for differences in leaf mass (g) among temperature treatments. P = significance level

Temperature Treatment	Mean Difference	P
18-22	0.03	0.9
18-26	0.4	<0.05
18-30	-0.02	0.9
22-26	0.4	<0.05
22-30	-0.06	0.9
26-30	-0.4	<0.05

3.5. Root mass

There was no significant difference in seagrass root mass between grazer treatments (ANOVA $df=3$, $F=2.246$, $p>0.05$), but root mass did differ statistically between temperature treatments (ANOVA $df=2$, $F=8.177$, $p<0.05$). Seagrasses in the 26°C treatment had a significantly higher root mass than seagrasses at 18°C and 30°C. The interaction between temperature and grazing did not significantly impact the root mass (ANOVA $df=6$, $F=1.13$, $p>0.05$).

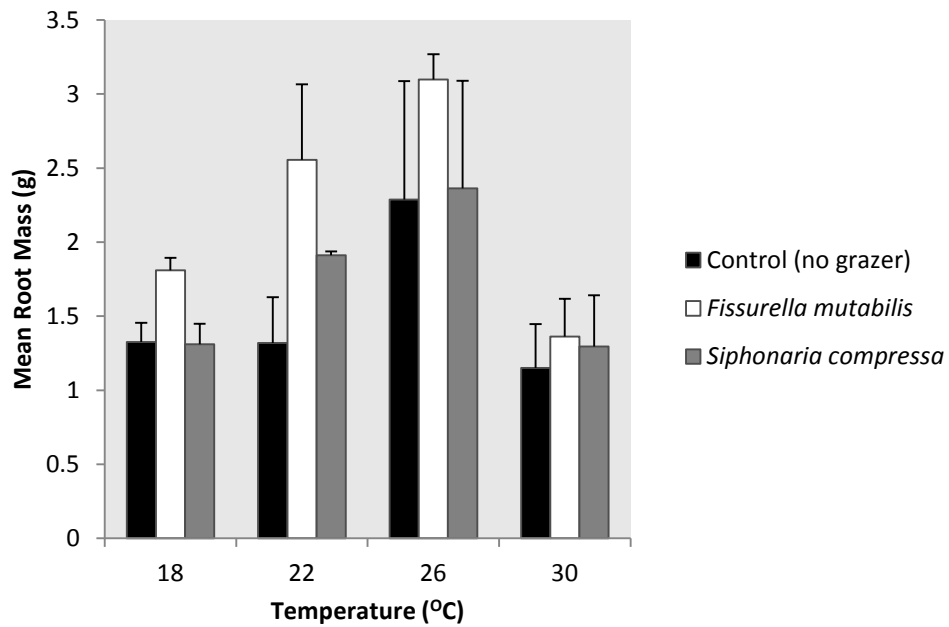

Figure 9: Mean (+ 1SE) root mass (g) between temperature and grazer treatments

Table 5: Results of post-hoc tests (Tukey's HSD) test for differences in root mass (g) among temperature treatments. P = significance level

Temperature Treatment	Mean Difference	P
18-22	0.4	0.5
18-26	1.1	<0.05
18-30	-0.2	0.9
22-26	0.7	0.2
22-30	0.7	0.2
26-30	-1.3	<0.05

3.6. Grazers

There was no significant effect of temperature on limpet deaths (ANOVA $df=1$, $F=0.0341$, $p>0.05$). There was a significantly higher percentage of deaths of *Fissurella mutabilis* than *Siphonaria compressa* (ANOVA $df=1$, $F=14.736$, $p<0.05$). The interaction between temperature and grazer also significantly affected limpet deaths (ANOVA $df=1$, $F=15.956$, $p<0.05$). There was no significant difference between the percentage of deaths of the grazers at 18°C and 22°C while at 26°C and 30°C there were greater mortalities of *Fissurella mutabilis* than *Siphonaria compressa* (Tukey's-HSD post hoc test $p<0.05$).

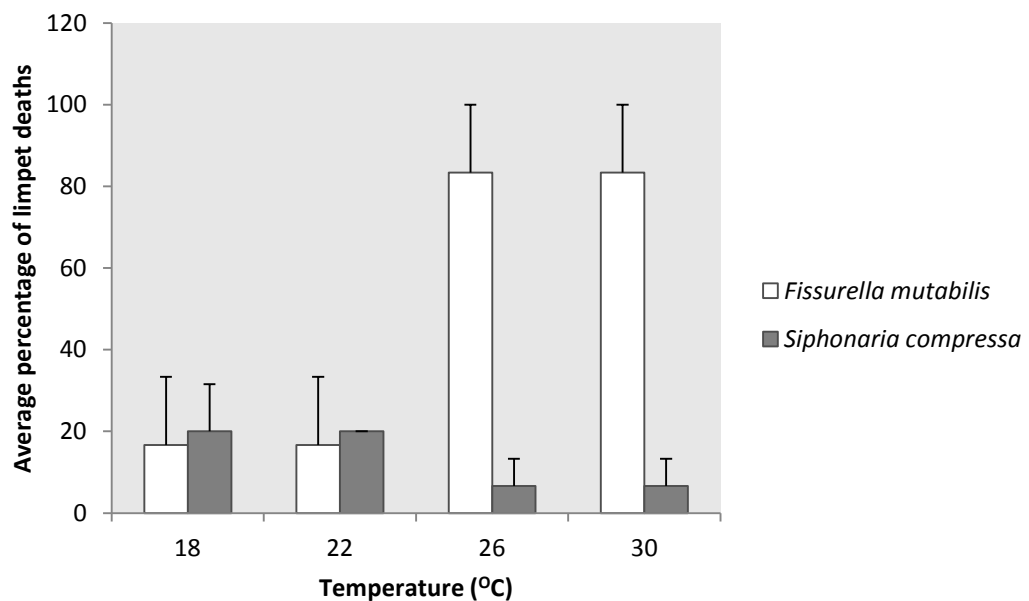

Figure 10: Mean (+ 1SE) limpet deaths between temperatures

4. Discussion

Changes in temperature can have significant effects on seagrass ecosystems (Short and Neckles, 1999, Orth *et al.*, 2006, Harley *et al.*, 2006, Morelissen and Harley, 2007, Wilson *et al.*, 2009, Philippart *et al.*, 2011, Doney *et al.*, 2012). The findings of this study are consistent with several other studies documenting the important effects temperature changes can have on seagrass systems on the whole (Harley *et al.*, 2006, Morelissen and Harley, 2007, Philippart *et al.*, 2011, Doney *et al.*, 2012). The findings of this experiment also have important implications for the future of seagrasses in Langebaan Lagoon for two reasons. Firstly, there has been a gradual increase in atmospheric temperature in the lagoon over the last 40 years (Fig. 1). Secondly, sea surface temperatures are expected to rise by an average of 2.5°C by the year 2050 (IPCC, 2001, Hiscock *et al.*, 2004). Given the latter, understanding how future rises in temperature can impact seagrasses and key interactions within these systems can assist in managing and conserving these systems and mitigating, to some degree, the threat of future warming.

4.1. Algal fouling

The relationship between algal fouling and temperature, grazing and their interactions recorded in this experiment was very complex. It is clear from this study that temperature has a major influence on the growth of algae on the seagrass blades, with increasing temperatures greatly increasing the amount of algae present on seagrass leaves. This is an important outcome of this study as algal fouling can limit seagrass growth and survival. This essentially occurs through algae limiting the availability of light and nutrients to seagrasses, resulting in poor performance and ultimately their death and overall decline in marine ecosystems (Short and Neckles, 1999, Shiel *et*

al., 2004, Harley *et al.*, 2006, Morelissen and Harley, 2007, Philippart *et al.*, 2011, Doney *et al.*, 2012). Previous studies on other seagrass species also highlighted the importance of water temperature in determining the magnitude and extent of the competition on seagrass by algal epiphytes (Short and Neckles, 1999, Duffy and Harvilicz, 2001, Harley *et al.*, 2006, Morelissen and Harley, 2007, Philippart *et al.*, 2011, Doney *et al.*, 2012), as benthic microalgal production is strongly influenced by temperature with photosynthetic rates increasing with temperature to an optimum of 30°C (Blanchard *et al.*, 1997, Morelissen and Harley, 2007). Thus, high water temperatures have been found to exacerbate the impact of algal epiphytes on the growth of seagrass through limiting light and carbon (Short and Neckles, 1999, Migne *et al.*, 2004, Harley *et al.*, 2006, Morelissen and Harley, 2007, Philippart *et al.*, 2011, Doney *et al.*, 2012).

Results of this experiment also show the importance of grazer presence (generally) and identity (specifically) in providing important “anti-fouling” functions for seagrasses, especially at high temperatures. This clearly indicates the importance of grazers for the persistence of seagrasses in Langebaan Lagoon, especially under future higher temperature conditions. Grazer feeding on epiphytic algae has been shown to enhance the survival and growth of seagrasses and other macrophytes (Jernakoff *et al.*, 1996, Duffy and Harvilicz, 2001, Doney *et al.*, 2012). The importance of grazer presence in reducing algae fouling was clearly shown by Duffy and Harvilicz (2001). Over a four week period seagrass without the presence of grazers accumulated a thick coating of epiphytic algae, whereas seagrass exposed to grazers showed a significant reduction of fouling (Duffy and Harvilicz, 2001). The importance of grazer presence is also emphasised by Thompson *et al.*, (2004), who showed using field data and manipulative experiments that reducing grazing intensity led to a considerable increase in the photosynthetic biomass of epiphytic algae (Thompson *et al.*, 2004). Morelissen and Harley (2007) showed that the presence of the limpet *Lottia scabra* had a strong, negative effect on microalgal biomass, thus emphasising the importance of grazer presence in reducing algae fouling on seagrass.

While the importance of grazer feeding on epiphytic microalgae is widely appreciated, subtle differences in feeding traits among grazers and its potential importance for understanding community structure and dynamics in marine vegetation is far less recognised. Small grazing invertebrates that inhabit marine plants were traditionally treated as a homogenous group, with similar ecology and feeding behaviour (Bell 1991, Duffy and Harvilicz, 2001). Duffy and Harvilicz (2001) conducted a study on grazing by two amphipod taxa, which produced strong but clearly different impacts on seagrass fouling levels. The presence of these grazers greatly reduced the fouling by algae, but seagrasses under the influence of the amphipod *Gammarus mucronatus* was generally clean of periphyton but became fouled by a heavy growth of *Polysiphonia harveyi* (red alga) while seagrass exposed to amphipod amphipods were free of all fouling organisms (Duffy and Harvilicz, 2001). While both amphipod taxa were of similar size their influence on fouling varied substantially indicating a clear difference between grazer impacts on microalgal presence.

The latter example is very relevant to the findings of this experiment. Apart from limpets overall reducing microalgal fouling of seagrasses in this experiment, limpet identity was also highly influential. While the generalist limpet *Fissurella mutabilis* plays an important role in the removal of microalgae films on seagrass blades, the obligate seagrass limpet *Siphonaria compressa* is far more effective. The latter is probably due to *S. compressa* having coevolved with seagrasses to survive solely with it, and therefore having better morphological adaptations to living on seagrasses, particularly the ability to graze microalgae off seagrass blades. Coevolved relationships are often intricate with mutually beneficial services being provided by each partner in the relationship (Loeuille *et al.*, 2002).

The interaction between grazer presence and temperature recorded in this study is illustrative of the complexity of interactions that take place in seagrass systems that ultimately determine algal fouling of seagrasses. At lower temperatures (18°C and 22 °C) algal fouling on seagrasses were similar between the various grazer treatments. This indicates that at low temperatures, the presence

of grazers is a statistically insignificant determinant of algal fouling on seagrasses. However at higher temperatures the presence of grazers appears vital in reducing the algal fouling. However, grazer identity, especially at higher temperatures, is also of importance in determining the level of algal fouling. *Siphonaria compressa* clearly managed to reduce algal biomass far more effectively than *F. mutabilis*. At higher temperatures, the effectiveness of the generalist limpet *F. mutabilis* therefore appears to lessen. At 30°C there was no difference in microalgal fouling of seagrasses between control plants and those with *F. mutabilis*. In contrast, seagrasses with the specialist limpet *S. compressa* had the least amount of microalgae on blades. This is a vital finding of the experiment, as future temperature rises can clearly enhance fouling of seagrasses by algae. However, the ability of *F. mutabilis* to graze on microalgae lessens at very high temperatures whereas *S. compressa* maintains its capacity to feed on algae, suggesting that under increased temperatures, *F. mutabilis* may be of little use in controlling algal fouling of seagrasses, but that *S. compressa* is of extreme importance. Under field conditions, regions which experience warmer temperatures, on average, have seagrass with almost only *S. compressa* present (Lawrence *pers data*, 2015, Fig. 11). These patches of seagrass also appear to have virtually no algal fouling and are in better condition than patches of seagrass which have on average lower temperatures and mostly *F. mutabilis* (Lawrence *pers data*, 2015, Fig. 11). Therefore, field observations concur with findings recorded in this experiment.

The survival of the limpets under different temperatures in the current experiment also concurs with field observations. *S. compressa* is better able to survive at higher temperatures (26°C and 30°C) while *F. mutabilis* experience a significantly greater death rate. This could explain why *S. compressa* is dominant in the warmer Geelbek region of Langebaan Lagoon and the predominant occurrence of *F. mutabilis* in cooler areas (Lawrence *pers data*, 2015, Fig. 11). Based on the results of the current experiment, future increases in temperature may lead to the demise of *F. mutabilis* but this may not necessarily be the case for *S. compressa*. This species-specific response to high water temperatures is very important to note, as understanding the thermal tolerances of critical species

in ecosystems will inform managers on the best management practices available to mitigate against future temperature rise.

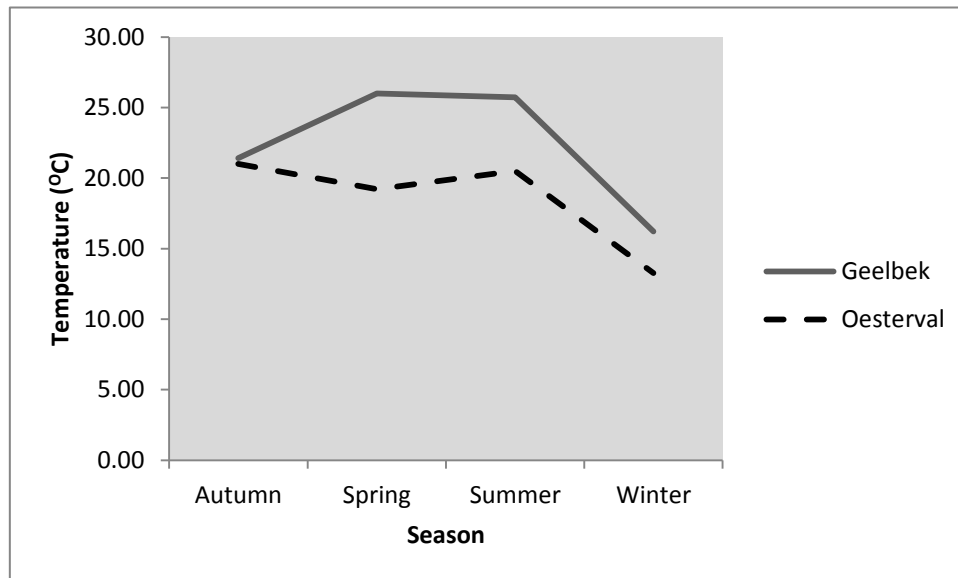

Figure 11: Mean seasonal temperatures for Geelbek and Oesterval sites in Langebaan Lagoon. Measured in 2014 (Lawrence *pers data*, 2015)

4.2. Seagrass leaf morphology

There were no substantial differences in leaf morphological attributes between temperature and grazer treatments at the termination of the experiment. Temperature stress coupled with the increases in fouling would have been expected to negatively affect leaf morphology. The lack of treatment effects could also be due to specific inherent biological and physiological traits of *Z. capensis* used in the experiment. In general, direct responses of plants to temperature depend on thermal tolerances of individual species and temperature optima for photosynthesis, respiration, and growth (Short and Neckles, 1999, Nejrup and Pedersen 2008). Life histories of seagrass will also influence how increasing temperatures will influence growth. The main problem with interpreting findings in the current experiment is that there have been no focused studies on temperature and

grazing effects on *Zostera capensis*. The only study of relevance was conducted by Edgcumbe (1980), However this was a preliminary study, and indicating that temperatures over 26°C may decrease growth rate. The study does suggest further investigation is required (Edgcumbe, 1980).

From previous studies it appears that warm water seagrasses increase rates of photosynthesis and respiration with increasing temperatures, while temperate species have photosynthetic optima at temperatures below seasonal maxima. Caution, however, must be applied when interpreting the above as these studies were not conducted comparatively and the different testing methods used may confound results obtained (Short and Neckles, 1999, Nejrup and Pedersen 2008).

Studies on the closely related seagrass, *Zostera marina*, are currently the best available for interpreting results obtained in the current experiment. It has been shown that high water temperatures have an overall negative influence on *Z. marina*. Very low temperatures (5°C) can slow down the photosynthetic rate and growth but has no effect on mortality. Higher temperatures, such as those experienced in this study (25°C -30°C), increased mortality and lowered the photosynthetic rate and growth of *Z. marina*. It appears that for *Z. marina*, the ideal water temperature lies between 10°C and 20°C (Nejrup and Pedersen, 2008). Mediterranean seagrass species (*Posidonia oceanic* and *Cymodocea nodosa*) also showed somewhat similar responses to *Z. marina* to experimental temperature changes. Leaf formation rates of *P. oceanic* declined with increasing temperatures. Rhizome growth and other plant performance indicators for *C. nodosa* increased with warming until a thermal threshold of around 30°C, beyond which performance declined (Olsen *et al.*, 2012). Importantly, the later experiments were run over three months. In contrast, the current experiment on *Z. capensis* was run for four weeks; there is therefore the potential that while the duration of the current experiment was adequate for assessing limpet survival and seagrass fouling, it was inadequate to assess impacts of treatments on plant morphological attributes. A similar explanation was provided by Duffy and Harvilicz (2001), who showed that despite grazing having dramatic impacts on mass and composition of fouling material, grazers had no significant impact on

the growth of the seagrass. It was concluded that the short running time of the experiment (four weeks) was insufficient to detect grazer induced affects on seagrass growth (Duffy and Harvilicz, 2001).

5. Conclusion

This is the first study testing the interactive effects of increasing temperatures and grazing by the obligate limpet *Siphonaria compressa* and the generalist limpet *Fissurella mutabilis* on the local seagrass *Zostera capensis* in South Africa. It is also one of the few studies globally which incorporates tests of the joint and individual effects of predicated increases of sea water temperature and grazing intensity on the performance of seagrasses. Results indicate that increasing temperatures will positively influence algal growth on seagrass blades but that grazing can limit the level of algal fouling, with the specialist limpet *Siphonaria compressa* being significantly more effective in preventing seagrass fouling, especially at high temperatures. *S. compressa* is also far more tolerant to higher temperatures than *F. mutabilis*.

The findings of this study are especially important for local conservation goals that involve the endemic critically endangered limpet *S. compressa* and a drastically declining vital ecosystem component, the seagrass *Z. capensis*. With changing climate and predicted rises in sea surface temperatures, it is critically important to be able to accurately predict ecosystem responses to these changes and adapt accordingly with scientifically robust management practices. These results suggest that while seagrasses themselves, a vital ecosystem component of Langebaan Lagoon requires protection, it may be more important to consider the conservation of associated seagrass fauna when attempting to conserve the seagrass. This could increase survival rates of the seagrass with corresponding positive effects on seagrass dwelling species. Overall, the results of this

experiment highlight the need to focus on advancing ecological understanding of the complex dynamics within this ecosystem and other structurally complex ecosystems, especially future climate change scenarios, with a focus on understanding the underlying mechanisms that allow systems to resist or submit to environmental change.

References

- Allanson, B. R., & Herbert, D. G. (2005). A newly discovered population of the critically endangered false limpet *Siphonaria compressa* Allanson, 1958 (Pulmonata: Siphonariidae), with observations on its reproductive biology: research letter. *South African journal of science*, 101(1 & 2), p-95.
- Allanson, B. R., & Msizi, S. C. (2010). Reproduction and growth of the endangered siphonariid limpet *Siphonaria compressa* (Pulmonata: Basommatophora). *Invertebrate Reproduction & Development*, 54(3), 151-161.
- Anderson, B. C., Smit, A. J., & Bolton, J. J. (1998). Differential grazing effects by isopods on *Gracilaria gracilis* and epiphytic *Ceramium diaphanum* in suspended raft culture. *Aquaculture*, 169(1), 99-109.
- Angel, A., Branch, G. M., Wanless, R. M., & Siebert, T. (2006). Causes of rarity and range restriction of an endangered, endemic limpet, *Siphonaria compressa*. *Journal of experimental marine biology and ecology*, 330(1), 245-260.
- Bell, S. S. (1991). Amphipods as insect equivalents? An alternative view. *Ecology*, 350-354.
- Blanchard, G. F., Guarini, J. M., Gros, P., & Richard, P. (1997). Seasonal effect on the relationship between the photosynthetic capacity of intertidal microphytobenthos and temperature¹. *Journal of Phycology*, 33(5), 723-728.
- Carlton, J. T., Vermeij, G. J., Lindberg, D. R., Carlton, D. A., & Dubley, E. C. (1991). The first historical extinction of a marine invertebrate in an ocean basin: the demise of the eelgrass limpet *Lottia alveus*. *The Biological Bulletin*, 180(1), 72-80.
- Chaparro, O. R., Montiel, Y. A., Segura, C. J., Cubillos, V. M., Thompson, R. J., & Navarro, J. M. (2008). The effect of salinity on clearance rate in the suspension-feeding estuarine gastropod

- Crepidatella dilatata* under natural and controlled conditions. *Estuarine, Coastal and Shelf Science*, 76(4), 861-868.
- Chapman, M. G. (1999). Are there adequate data to assess how well theories of rarity apply to marine invertebrates?. *Biodiversity & Conservation*, 8(10), 1295-1318.
- Coleman, R. A., Underwood, A. J., Benedetti-Cecchi, L., Åberg, P., Arenas, F., Arrontes, J., Castro, J., Hartnoll, R. G., Jenkins, S. R., Paula, J., Santana, P. D., & Hawkins, S. J. (2006). A continental scale evaluation of the role of limpet grazing on rocky shores. *Oecologia*, 147(3), 556-564.
- Cubit, J. D. (1984). Herbivory and the seasonal abundance of algae on a high intertidal rocky shore. *Ecology*, 65(6) 1904-1917.
- Dahlhoff, E. P., Buckley, B. A., & Menge, B. A. (2001). Physiology of the rocky intertidal predator *Nucella ostrina* along an environmental stress gradient. *Ecology*, 82(10), 2816-2829.
- Doney, S. C., Ruckelshaus, M., Emmett Duffy, J., Barry, J. P., Chan, F., English, C. A., Galindo, H. M., Grebmeier, J., Hollowed, A. B., Knowlton, N., Polovina, J., Rabalais, N. N., Sydeman W. J., & Talley, L. D. (2012). Climate change impacts on marine ecosystems. *Annual review of marine science*, 4, 11-37.
- Duarte, C. M., Middelburg, J. J., & Caraco, N. (2005). Major role of marine vegetation on the oceanic carbon cycle. *Biogeosciences*, 2(1), 1-8.
- Duffy, J. E., & Harvilicz, A. M. (2001). Species-specific impacts of grazing amphipods in an eelgrass-bed community. *Marine Ecology Progress Series*, 223, 201-211.
- Edgcumbe, D. J. (1980). Some preliminary observations on the submerged aquatic *Zostera capensis* Setchell. *Journal of South African Botany*, 46(1), 53-66.

- Eklöf, J. S., Alsterberg, C., Havenhand, J. N., Sundbäck, K., Wood, H. L., & Gamfeldt, L. (2012). Experimental climate change weakens the insurance effect of biodiversity. *Ecology letters*, *15*(8), 864-872.
- Fields, P. A., Graham, J. B., Rosenblatt, R. H., & Somero, G. N. (1993). Effects of expected global climate change on marine faunas. *Trends in Ecology & Evolution*, *8*(10), 361-367.
- Garthwin, R. G., Poore, A. G., & Vergés, A. (2014). Seagrass tolerance to herbivory under increased ocean temperatures. *Marine pollution bulletin*, *83*(2), 475-482.
- Hansen, J. P., Robertson-Andersson, D., & Troell, M. (2006). Control of the herbivorous gastropod *Fissurella mutabilis* (Sow.) in a land-based integrated abalone–seaweed culture. *Aquaculture*, *255*(1), 384-388.
- Harley, C. D. (2002). Light availability indirectly limits herbivore growth and abundance in a high rocky intertidal community during the winter. *Limnology and Oceanography*, *47*(4), 1217-1222.
- Harley, C. D., Randall Hughes, A., Hultgren, K. M., Miner, B. G., Sorte, C. J., Thornber, C. S., Rodriguez, L. F., Tomanek, L., & Williams, S. L. (2006). The impacts of climate change in coastal marine systems. *Ecology letters*, *9*(2), 228-241.
- Helmuth, B. S., & Hofmann, G. E. (2001). Microhabitats, thermal heterogeneity, and patterns of physiological stress in the rocky intertidal zone. *The Biological Bulletin*, *201*(3), 374-384.
- Helmuth, B., Harley, C. D., Halpin, P. M., O'Donnell, M., Hofmann, G. E., & Blanchette, C. A. (2002). Climate change and latitudinal patterns of intertidal thermal stress. *Science*, *298*(5595), 1015-1017.

- Hiscock, K., Southward, A., Tittley, I., & Hawkins, S. (2004). Effects of changing temperature on benthic marine life in Britain and Ireland. *Aquatic Conservation: marine and freshwater Ecosystems*, 14(4), 333-362.
- Hodgson, A. N. (1999). The biology of *siphonariid* limpets (Gastropoda: Pulmonata). *Oceanography and Marine Biology, An Annual Review*, 37, 245-314.
- IPCC (2001). *Climate change 2001, Synthesis Report. A Contribution of Working Groups I, II, and III to the Third Assessment Report of the Intergovernmental Panel on Climate Change*. Cambridge University Press, Cambridge, UK.
- Jernakoff, P., Brearley, A., & Nielsen, J. (1996). Factors affecting grazer-epiphyte interactions in temperate seagrass meadows. *Oceanography and Marine Biology: an annual review*, 34.
- Kendrick, G. A., & Lavery, P. S. (2001). Assessing biomass, assemblage structure and productivity of algal epiphytes on seagrasses. *Global Seagrass Research Methods*. Elsevier, Amsterdam, 199-222.
- Keser, M., Swenarton, J. T., & Foertch, J. F. (2005). Effects of thermal input and climate change on growth of *Ascophyllum nodosum* (Fucales, Phaeophyceae) in eastern Long Island Sound (USA). *Journal of Sea Research*, 54(3), 211-220.
- Koch, M. S., Schopmeyer, S., Kyhn-Hansen, C., & Madden, C. J. (2007). Synergistic effects of high temperature and sulfide on tropical seagrass. *Journal of Experimental Marine Biology and Ecology*, 341(1), 91-101.
- Lawrence (2015). Dynamics of *Zostera capensis* in Langebaan Lagoon, South Africa – Environmental and Biological Influences. *Unpublished PhD data*.
- Leonard, G. H. (2000). Latitudinal variation in species interactions: a test in the New England rocky intertidal zone. *Ecology*, 81(4), 1015-1030.

- Lirman, D., & Cropper, W. P. (2003). The influence of salinity on seagrass growth, survivorship, and distribution within Biscayne Bay, Florida: field, experimental, and modeling studies. *Estuaries*, 26(1), 131-141.
- Loeuille, N., Loreau, M., & Ferriere, R. (2002). Consequences of plant-herbivore coevolution on the dynamics and functioning of ecosystems. *Journal of theoretical biology*, 217(3), 369-381.
- Lubchenco, J., Navarrete, S. A., Tissot, B. N., & Castilla, J. C. (1993). Possible ecological responses to global climate change: nearshore benthic biota of northeastern Pacific coastal ecosystems. *Earth System Responses to Global Change: Contrasts Between North and South America*. Money HA, Fuentes ER, Kronberg BI, Eds. (Academic Press, San Diego) pp, 147-166.
- Marba, N., Cebrian, J., Enriquez, S., & Duarte, C. M. (1996). Growth patterns of Western Mediterranean seagrasses: species-specific responses to seasonal forcing. *Marine ecology progress series*. Oldendorf, 133(1), 203-215.
- Migné, A., Spilmont, N., & Davoult, D. (2004). In situ measurements of benthic primary production during emersion: seasonal variations and annual production in the Bay of Somme (eastern English Channel, France). *Continental Shelf Research*, 24(13), 1437-1449.
- Morelissen, B., & Harley, C. D. (2007). The effects of temperature on producers, consumers, and plant-herbivore interactions in an intertidal community. *Journal of Experimental Marine Biology and Ecology*, 348(1), 162-173.
- Nejrup, L. B., & Pedersen, M. F. (2008). Effects of salinity and water temperature on the ecological performance of *Zostera marina*. *Aquatic Botany*, 88(3), 239-246.
- Nicotri, M. E. (1977). Grazing effects of four marine intertidal herbivores on the microflora. *Ecology*, 1020-1032.

- Nielsen, K. J. (2001). Bottom-up and top-down forces in tide pools: test of a food chain model in an intertidal community. *Ecological Monographs*, 71(2), 187-217.
- Nyström, M., Norström, A. V., Blenckner, T., de la Torre-Castro, M., Eklöf, J. S., Folke, C., Osterblom, H., Steneck, R. S., Thyresson, M., & Troell, M. (2012). Confronting feedbacks of degraded marine ecosystems. *Ecosystems*, 15(5), 695-710.
- Olsen, Y. S., Sánchez-Camacho, M., Marbà, N., & Duarte, C. M. (2012). Mediterranean seagrass growth and demography responses to experimental warming. *Estuaries and coasts*, 35(5), 1205-1213.
- Orth, R. J., Carruthers, T. J., Dennison, W. C., Duarte, C. M., Fourqurean, J. W., Heck, K. L., Randall, J., Kendrick, G. A., Kenworthy, W. J., Olyarnik, S., Short, F. T., Waycott, M., & Williams, S. L. (2006). A global crisis for seagrass ecosystems. *Bioscience*, 56(12), 987-996.
- Parpagnoli, D., Pecchioli, S., & Santini, G. (2013). Temporal determinants of grazing activity in the Mediterranean limpet *Patella caerulea*. *Ethology Ecology & Evolution*, 25(4), 388-399.
- Philippart, C. J., Anadón, R., Danovaro, R., Dippner, J. W., Drinkwater, K. F., Hawkins, S. J., Oguz, T., O'Sullivan, G., & Reid, P. C. (2011). Impacts of climate change on European marine ecosystems: observations, expectations and indicators. *Journal of Experimental Marine Biology and Ecology*, 400(1), 52-69.
- Pillay, D., Branch, G. M., Griffiths, C. L., Williams, C., & Prinsloo, A. (2010). Ecosystem change in a South African marine reserve(1960-2009): role of seagrass loss and anthropogenic disturbance. *Marine Ecology Progress Series*, 415, 35-48.
- Sanford, E. (1999). Regulation of keystone predation by small changes in ocean temperature. *Science*, 283(5410), 2095-2097.

- Short, F. T., & Duarte, C. M. (2001). Methods for the measurement of seagrass growth and production. In: Short, F. T., & Coles, R. G. (eds). *Global seagrass research methods*, Chapter 8, 155-182.
- Short, F. T., & Neckles, H. A. (1999). The effects of global climate change on seagrasses. *Aquatic Botany*, 63(3), 169-196.
- Somero, G. N. (2002). Thermal physiology and vertical zonation of intertidal animals: optima, limits, and costs of living. *Integrative and Comparative Biology*, 42(4), 780-789.
- Suchanek, T. H., Williams, S. L., Ogden, J. C., Hubbard, D. K., & Gill, I. P. (1985). Utilization of shallow-water seagrass detritus by Caribbean deep-sea macrofauna: $\delta_{13}C$ evidence. *Deep Sea Research Part A. Oceanographic Research Papers*, 32(2), 201-214.
- Ter Morshuizen, L. D., & Whitfield, A. K. (1994). The distribution of littoral fish associated with eelgrass *Zostera capensis* beds in the Kariega estuary, a southern African system with a reversed salinity gradient. *South African Journal of Marine Science*, 14(1), 95-105.
- Terrados, J., Duarte, C. M., Kamp-Nielsen, L., Agawin, N. S. R., Gacia, E., Lacap, D., Fortes, M. D., Borum, J., Lubanski, M., & Greve, T. (1999). Are seagrass growth and survival constrained by the reducing conditions of the sediment?. *Aquatic Botany*, 65(1), 175-197.
- Thompson, R. C., Norton, T. A., & Hawkins, S. J. (2004). Physical stress and biological control regulate the producer-consumer balance in intertidal biofilms. *Ecology*, 85(5), 1372-1382.
- Thompson, R. C., Roberts, M. F., Norton, T. A., & Hawkins, S. J. (2000). Feast or famine for intertidal grazing molluscs: a mis-match between seasonal variations in grazing intensity and the abundance of microbial resources. In: *Island, Ocean and Deep-Sea Biology* (pp. 357-367). Springer Netherlands.

Valentine, J. F., & Heck Jr, K. L. (2005). Perspective review of the impacts of overfishing on coral reef food web linkages. *Coral Reefs*, 24(2), 209-213.

Waycott, M., Duarte, C. M., Carruthers, T. J., Orth, R. J., Dennison, W. C., Olyarnik, S., Calladine. A., Fourqurean, J. W., Heck, K. L., Hughes, R.A., Kendrick.G.A., Kenworthy. W. J., Short. F. T., & Williams, S. L. (2009). Accelerating loss of seagrasses across the globe threatens coastal ecosystems. *Proceedings of the National Academy of Sciences*, 106(30), 12377-12381.

Wilson, G., Branch, G. M., & de Coito, P. (2009). Comparative salinity tolerances of four siphonariid limpets in relation to habitat restriction of the rare and endangered *Siphonaria compressa*. *African Journal of Marine Science*, 31(3), 311-318.