

Report of the Scientific Committee

Bled, Slovenia, 12-24 May 2014

Annex H: Report of the Sub-Committee on Other Southern Hemisphere Whale Stocks

**This report is presented as it was at SC/65b.
There may be further editorial changes (e.g. updated references, tables and figures)
made before publication.**

**International Whaling Commission,
Bled, Slovenia, 2014**

Annex H

Report of the Sub-Committee on Other Southern Hemisphere Whale Stocks

Members: Robbins (Convenor), Alzahlawi, Baba, Baker, Bannister, Baulch, Bell, Blatnik, Bravington, Brockington, Butterworth, Carlson, Chilvers, Collins, Cooke, Currey, de la Mare, Donovan, Double, Feindt-Herr, Findlay, Funahashi, Gales, Galletti Vernazzani, Garrigue, Goodman, Gunnlaugsson, Heide-Jorgensen, Holm, Iñíguez, Jackson, Kato, Kaufman, Kelly, Kishiro, Kitakado, Kock, Lang, Lauriano, Lundquist, Marcondes, Mate, Matsuoka, Mattila, Miller, Miyashita, Moronuki, Murase, Nelson, Øien, Palacios, Palsbøll, Pastene, Pinta Gama, Rendell, Reyes, Roel, Rosenbaum, Ross-Gillespie, Scheidat, Skaug, Thomas, Vély, Wade, Weinrich, Williams, Willson, Yasokawa, Yoshida, Zerbini

1. INTRODUCTORY ITEMS

1.1 Opening remarks

Robbins welcomed the participants noting that a pre-meeting was held on May 10-11 to continue the assessment of Southern Hemisphere humpback whale Breeding Stocks D/E/F, which would be completed during SC/65b.

1.2 Election of Chair

Robbins was elected Chair.

1.3 Appointment of rapporteurs

Findlay undertook the duties of rapporteur.

1.4 Adoption of the Agenda

The adopted agenda is provided in Appendix 1. A number of members of the Scientific Committee were unable to participate in discussions regarding papers originating from JARPA II (see Annex U for an explanation). These include members who have previously participated in discussions of JARPA II. Therefore, it should be noted that the discussion of such papers in this report does not include the views of those members of the Scientific Committee.

1.5 Review of documents

The following documents were available for the meeting: SC/65b/SH01-20, SC/65b/IA10, Alexander *et al.* (2012), Double *et al.* (2014), Fossette *et al.* (2014), Miller *et al.* (2014a), Miller *et al.* (2014b), Olsen and Kinzey (In press), Orgeret *et al.* (In review), Polanowski *et al.* 2014, Shabangu and Findlay (2014), Torres-Florez *et al.* (2014), Van Opzeeland *et al.* (2014).

2. SOUTHERN OCEAN RESEARCH PARTNERSHIP

SC/65b/SH12rev provided an overview of Southern Ocean Research Partnership (IWC-SORP) progress since SC/65a. Progress made by the five on-going research projects is summarised below.

SC/65b/SH12rev Annex 1 provided an update on the *Antarctic Blue Whale Project*. Its objectives are to improve current understanding of the status of the Antarctic blue whales and their role in the Antarctic ecosystem. The project has recently cooperated on five voyages to the Southern Ocean: (1) 2013 Voyage to the Ross Sea, led by the Australian Antarctic Division (SC/65a/SH21); (2) 2013/14 Whale Song Antarctic Voyage for Ecosystem Studies (WAVES) Expedition, led by the Centre for Whale Research, Australia; (3) 2014 voyage to the Antarctic Peninsula, an initiative of the South American Consortium led by Argentina (SC/65b/SH16Rev); (4) South African voyage to the Queen Maud Land coast (SC/65b/SH01); and (5) CETA voyage to the Dumont d'Urville Sea led by France (SC/65b/SH05). Data are also being augmented with information from ships of opportunity that contribute sightings data to the online reporting system: www.marinemammals.gov.au/sorp/sightings. In total, fourteen primary papers have been submitted to SC/65b outlining the major results of the project. Sub-committee discussion of this work can be found under Item 5.1.

SC/65b/SH12rev Annex 2 summarised recent progress on *The distribution, relative abundance, migration patterns and foraging ecology of three ecotypes of killer whales in the Southern Ocean* project. Field work has been undertaken in the Ross Sea and the western Antarctic Peninsula, as well as around Marion Island, in the sub-Antarctic. Italy has recently joined IWC-SORP and research has been funded by the Italian National Antarctic Programme (PNRA) to study killer whales in Terra Nova Bay, Ross Sea. An exchange of personnel between McMurdo and Mario Zucchelli stations for the upcoming austral field season is under discussion. This project is of primary relevance to the Sub-Committee on Small Cetaceans and their discussion can be found in Annex L.

SC/65b/SH12rev Annex 3 provided an update on *The foraging ecology and predator-prey interactions between baleen whales and krill: a multi-scale comparative study across Antarctic regions* project. This project is conducting ecological research on cetaceans around the Antarctic Peninsula and developing methodological tools that can be applied across

Antarctic regions to better understand baleen whale movement and behaviour in relation to prey and environmental variability. From December 2013 - February 2014, IWC-SORP investigators participated in the U.S. National Science Foundation Long Term Ecological Research (LTER) cruise to the western side of the Antarctic Peninsula. During the cruise, visual sighting surveys were conducted while the ship transited between pre-determined sampling stations along the continental shelf waters. The survey data will be used in a long-term data base to determine how the distribution and abundance of cetaceans relates to environmental conditions within the LTER study area and how these change relative to changing ocean and sea ice conditions. Biopsy samples (101 humpback and 3 minke whale samples) were collected in support the following long-term research objectives: (1) determining the proportion of different breeding stocks represented within the LTER study region, (2) understanding the population demographics of whales in the LTER study region by measuring sex ratios and pregnancy rates, and (3) measuring stable isotopes to test for regional differences in feeding preferences. Results of satellite tagging during the 2012/2013 Palmer LTER research cruise supported the hypothesis that the long-term movement patterns and home-ranges of humpback whales in Antarctic waters reflect the broad scale distribution and movement patterns of Antarctic krill. Discussion of aspects of this research can be found in Annex G.

SC/65b/SH12rev Annex 4 provided an update on a humpback connectivity project, *What is the distribution and extent of mixing of Southern Hemisphere humpback whale populations around Antarctica? Phase 1: East Australia and Oceania*. This project focused on clarifying linkages between humpback whales off New Zealand and the Samoas (American and Independent) to other Oceania regions and east Australia. SC/65b/SH07 reports the results of molecular genetic analysis of samples from New Zealand and this is discussed under Item 3.2.1. Samples from American Samoa and Independent Samoa have also been genetically compared to other sites in Oceania and those results will be available at SC/66a. The project also plans to satellite tag whales on their southern migration past Raoul Island and on their American Samoa breeding ground to better determine their Antarctic feeding grounds. This portion of the project has been temporarily delayed to allow for further satellite tagging evaluation and improvements (SC/65a/SH05).

SC/65b/SH12rev Annex 5 reported on the *Acoustic trends in abundance, distribution, and seasonal presence of Antarctic blue whales and fin whales in the Southern Ocean* project. A preliminary analysis was conducted of all of the available acoustic data showing the geographic and seasonal occurrence of blue and fin whales around the Antarctic. The IWC-SORP Acoustic Trends Working Group (ATWG) concluded that a coordinated effort to collect new acoustic data using consistent spatial and temporal coverage, instruments and analytical methods, would be the best way to achieve the aims of the project. To best utilise passive acoustic methods for monitoring purposes in the future, the ATWG proposed the placement and maintenance of a circumpolar Antarctic monitoring system with at least one hydrophone in each of the six IWC management areas: the Southern Ocean Hydrophone Network (SOHN). Guidelines and recommendations for instrument choice, hardware configurations and analysis methods to propose how data might be best collected and analysed in a uniform manner to best address the specific research questions for both blue and fin whales have been produced (see Van Opzeeland *et al.* (2014) and Item 5.1.1.3 for details). Future efforts will focus on finding collaborators and funding to deploy and operate the circumpolar Antarctic monitoring network.

In total, IWC-SORP researchers submitted 22 papers to SC/65b. To date, the outputs from the five research projects total 36 peer-reviewed papers in scientific journals, with several more in preparation. Sixteen conference presentations have been made by SORP researchers since SC/65a, including at the IWC-SORP Special Session at the 20th Biennial Conference on the Biology of Marine Mammals. Intersessional work has also been carried out on the IWC-SORP website, in anticipation of it being hosted by the IWC: <http://www.marinemammals.gov.au/sorp>.

The sub-committee welcomed these updates and encouraged the ongoing endeavours of this productive research partnership.

3. ASSESSMENT OF SOUTHERN HEMISPHERE HUMPBACK WHALES

The IWC Scientific Committee currently recognises seven humpback whale breeding stocks (BS) in the Southern Hemisphere (labeled A to G; IWC, 1998), which are connected to feeding grounds in the Antarctic. An additional population that does not migrate to high latitudes is found in the Arabian Sea.

3.1 Assessment of Southern Hemisphere Breeding Stocks D/E/F

In 2011, the sub-committee initiated the re-assessment of BSD, and the assessment of BSE and BSF. As shown in Fig. 1, these stocks correspond, respectively, to humpback whales wintering off Western Australia (BSD), Eastern Australia (sub-stock BSE1) and the western Pacific Islands of Oceania (herein referred to as BSO). BSO includes New Caledonia (sub-stock BSE2), Tonga (sub-stock BSE3), the Cook Islands and French Polynesia (sub-stock BSF).

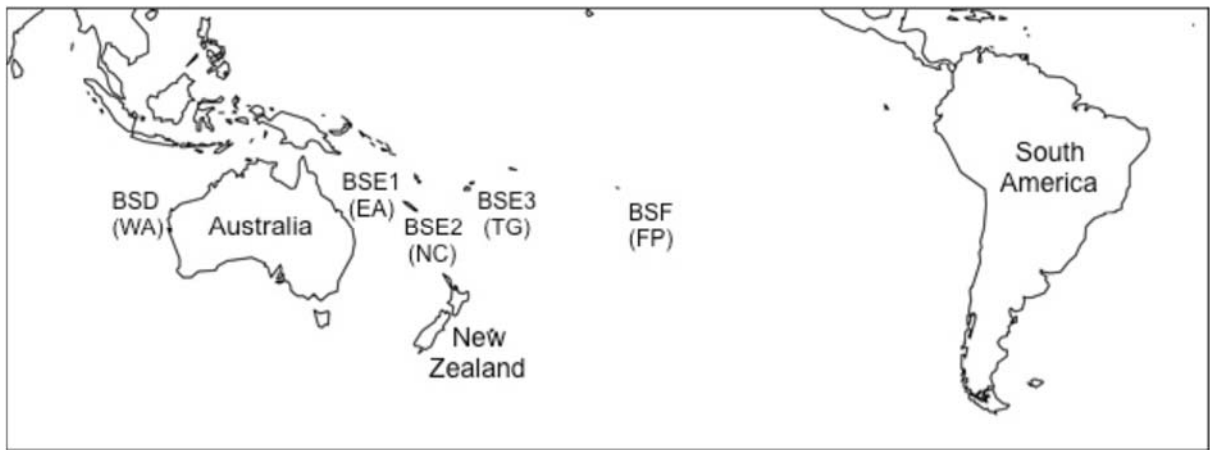

Fig. 1. Distribution of Southern Hemisphere humpback whales breeding stocks grounds BSD, BSE1, BSO (BSE2, BSE3 and BSF). Note the following abbreviations: WA = Western Australia, EA = Eastern Australia, NC = New Caledonia, TG = Tonga and FP = French Polynesia.

These are the last breeding stocks remaining in the Comprehensive Assessment of Southern Hemisphere humpback whales, and their assessments were to be completed as a matter of high priority during SC/65b. To complete the assessment, the SC earlier recommended that the following work be carried out intersessionally (IWC 2014, p. 254):

- (1) A lower bound on the BSD abundance estimate should be obtained.
- (2) A single-stock model for BSD is required for a range of choices of the Antarctic feeding ground catches between 120°E and 150°E.
- (3) Two stock BSE1-Oceania models (with further breeding stock division within Oceania) require exploration.
- (4) If time permits after sufficient exploration of the above models, more complex options may be examined. These options include a three-stock model covering all of BSD, BSE1 and Oceania, together perhaps with more complex models for the dynamics of BSD.

Item 1 had arisen after the previous modelling attempts were unable to simultaneously fit the Hedley *et al.* (2011) absolute abundance estimate for BSD for 2008, as well as reflect the high growth rate informed by the relative abundance series from Hedley *et al.* (2011). Discussions in SC/65a had identified some uncertainty about the absolute abundance estimate, and it was decided that it should be excluded from the model fitting process and that, as information on the abundance was required by the Bayesian estimation process, an uninformative uniform prior should be used instead, with a lower bound informed by further work (IWC, 2014, p. 252).

Hedley, who was unable to attend the meeting, had attempted to calculate a minimum estimate of BSD abundance based on a strip transect analysis of aerial survey data from Shark Bay, Western Australia (Hedley *et al.* 2011; IWC 2014 Annex H, Appendix 8). Preliminary results were given intersessionally indicating a lower bound value of 4900 [95% CI, 4100, 7900] for surface available whales in 2008. In providing these results, Hedley drew attention to the fact that the estimate was lower than expected and suggested several possible reasons, including that: (1) the searching protocol used on the surveys invalidated the hazard probability of seeing a cue, (2) not all surface available whales within the strip were detected, and (3) that narrowing the surveyed strips for the strip analysis had reduced the risk of pods being double-counted. These possibilities could not be evaluated intersessionally, and so she advised that this estimate be used as a lower bound in the assessment modelling, but should be considered tentative and requiring confirmation. She suggested a correction for surface availability of 0.3-0.4, following Hedley *et al.* (2011). Based on this information, a rounded estimate of the lower bound of BSD abundance of 15000 was assumed and the BSD assessments presented use a uniform prior of $U[\ln 15\ 000, \ln 40\ 000]$ for the log of the target abundance estimate for 2008.

3.1.1 Results of models developed intersessionally

SC SC/65b/SH04rev provided the intersessional model results for:

- (1) a single-stock model for BSD for a range of choices of the Antarctic feeding ground catches between 120°E and 150°E and utilising the uninformative uniform prior for the BSD target abundance estimate; and
- (2) a selection of BSE1-BSO two-stock models which had been proposed and circulated to the intersessional email group.

SC/65b/SH04addendum contained the intersessional model results for:

- (1) one further BSE1 - BSO two-stock model (carried out as a sensitivity run in which no Antarctic catch boundary was applied between the two breeding stocks, and catches being allocated according to total population densities);
- (2) two BSD-BSE1 two-stock models;

- (3) two-stock BSD - BSE1+BSE2 models where BSE1 (East Australia) and BSE2 (New Caledonia) are considered as one breeding stock; and
- (4) a three-stock model similar to the one that was run for SC/65a (IWC 2014 Annex H), but replacing the Hedley *et al.* (2011) absolute abundance estimate with the uninformative uniform prior for the BSD target abundance estimate as discussed above.

Apart from the BSD absolute abundance estimate, the data used in the model runs were essentially those used in previous years. The following points were highlighted by the authors in the results of these intersessional model runs:

3.1.1.1 SINGLE-STOCK BSD MODEL

The replacement of the Hedley *et al.* (2011) absolute abundance estimate for BSD with an uninformative uniform prior on the log of the target abundance estimate resulted in a marked improvement over the inclusion of the absolute abundance estimate in the model fitting process.

The shifting of the BSD/BSE1 feeding ground boundaries showed that the model-predicted median N_{2008} value is closest to the Hedley *et al.* (2011) 2008 absolute abundance estimate when the largest possible number of catches is allocated to BSD. However such an eastward shift of the boundary removes catches from BSE1 with consequent difficulties arising within the BSE1 assessment.

3.1.1.2 TWO-STOCK BSE1+BSO MODELS

The estimated growth rate for BSE1 was virtually at the demographic boundary imposed by the model, which resulted in a very narrow probability envelope for the BSE1 population trajectory. The importance function (placed on the prior to improve sampling efficiency) for r^{EI} utilised in these assessments could possibly be adjusted to further increase the efficiency of model runs that involved BSE1.

The N_{min} constraint for BSO continued to be problematic, since plots for runs when the N_{min} constraint was excluded were visibly different with the median population trajectory going below the N_{min} constraint value. Results for the third two-stock BSE1-BSO model (provided in the SC/65b/SH04addendum) showed that the exclusion of the N_{min} constraints also made a substantial difference to the model results (feeding ground catches for this model run were allocated in proportion to total population sizes). This exclusion of the BSO N_{min} constraint also slightly improved the BSO fit to the Constantine *et al.* (2012) mark-recapture data. The shifting of the Antarctic feeding ground boundaries had a greater impact (in likelihood terms) on BSE1 than BSO, and the best likelihood values resulted when the largest numbers of catches were allocated to BSE1. The authors noted that a decision would be needed on where to set the Antarctic feeding ground catch boundaries.

3.1.1.3 TWO-STOCK BSD - BSE1+BSE2 MODEL

This model was run as a sensitivity to the BSD – BSE1 model. Results did not provide substantial additional insights compared to other model runs.

3.1.1.4 TWO-STOCK BSD - BSE1 MODELS

As with the single-stock BSD model the removal of the 2008 Hedley *et al.* (2011) absolute abundance estimate from the data fitted substantially improved the fit to the relative abundance series for BSD in the BSD-BSE1 two-stock model.

3.1.1.5 THREE-STOCK MODEL

It was noted that the effects of the BSO N_{min} value extended to BSD (in terms of growth rate and carrying capacity estimates) within the three-stock model.

3.1.2 Specification and evaluation of additional model runs

In discussion of SC/65b/SH04 and SC/65b/SH04addendum, the sub-committee **agreed** that the three-stock model (Fig. 2) best captured the uncertainty in high latitude catch allocations across the three breeding stocks. It was **agreed** to focus on this model for further runs. Given identified issues with both N_{min} constraints and the allocation of catches from longitudinal feeding ground sectors to particular breeding stocks, it was **agreed** that sensitivity runs would be carried out on these parameters.

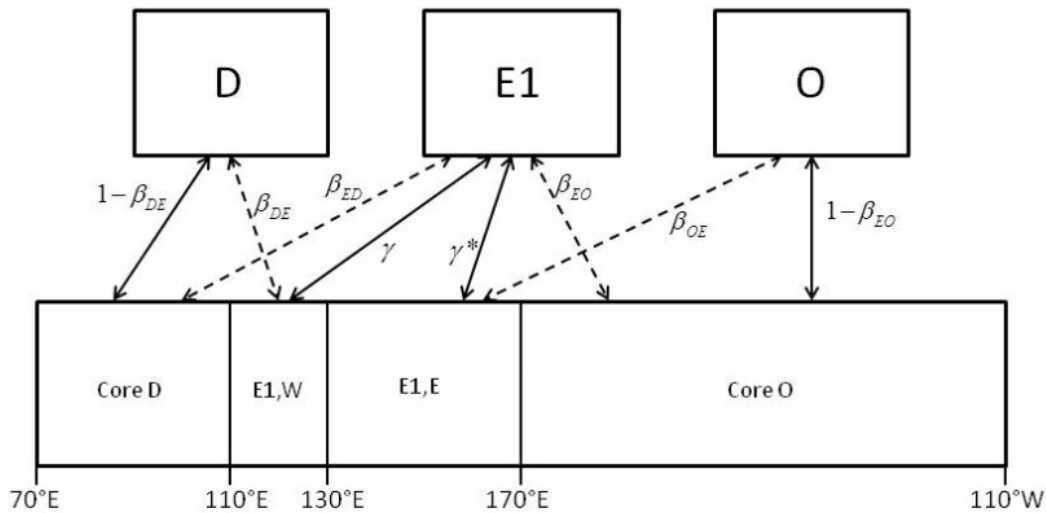

Fig. 2. Diagrammatic representation of the original three stock-model used in SC/65b/SH04addendum.

3.1.2.1 N_{min} FOR BSO

In evaluating the effects of N_{min} on the original three-stock model, it was noted that the N_{min} value used for BSO would be more defensible if only private haplotypes were used. The private haplotypes observed may also be a positively biased estimate, since some low frequency haplotypes may not be private, but have not been detected on other breeding grounds because sample sizes are insufficient to detect them (e.g. Appendix 2, Annex H, IWC, 2011). No downward correction for this possibility was employed in the assessment. Jackson provided private haplotype values of 27 for BSD, 5 for BSE and 42 for Oceania, based on Olavarria *et al.* (2007), although the number of private haplotypes for BSO was later revised further downwards to 33 based on additional genetic data (Olavarria, 2006). On the basis of the use of private haplotype values providing markedly better model fits, it was decided that future model runs should be based on using the private haplotypes values for N_{min} , although runs incorporating the revised N_{min} values produced a lower intrinsic growth rate (r) value of 0.078 for BSD compared to a 9 percent increase rate estimated from survey data alone (Bannister and Hedley, 2001).

The impacts of the N_{min} constraint on the posterior median estimates of stock distribution parameters was discussed. It was noted that the 90% confidence intervals are broadly unchanged when the N_{min} constraints were excluded, but that the plotting of the distributions of the post-model-pre-data and the posterior distributions for the estimated stock distribution parameters would be valuable. Probability distribution plots of the post-model-pre-data and the posterior distributions for the estimated stock distribution parameters and growth rates for the three-stock model were provided for three scenarios, namely a) the case where the BSO N_{min} constraint of 33*3 had been implemented; b) the case where the Appendix 2 mixing proportions (see below) had been included in the likelihood, and c) the results of the original model with BSO N_{min} constraint value of 42*3. Although a factor of four has been used in prior assessments, it has subsequently agreed that three should be the minimum bound for N_{min} (IWC 2012, Annex I). These post-model-pre-data distributions are the distributions of the parameters after basic model constraints have been taken into account (such as the population sizes having to remain positive, or disallowing for the majority of one breeding stock from feeding in a neighbouring area and *vice versa*), and comparisons with the posterior distributions provide an indication of how the prior distribution for any particular parameter is updated by the data. As has been the case in the past, the BSE1 growth rate parameter r is updated strongly towards its demographic upper bound, with virtually only values greater than 0.1 being resampled, which is why an importance function had been placed on the prior for that parameter to improve sampling efficiency. The only stock distribution parameter that was substantially updated by the data is γ^* (the proportion of E1 whales that feed in the E1,E area between 130°E and 170°E) for which higher values are favoured. However, the way the constraint that the proportions from the E1 stock sum to 1 was implemented meant that high values for the stock distribution parameters are sampled less often which can lead to ineffective sampling when stock distribution parameters are likely to be high (for example γ^* , where a large proportion of low values sampled for γ^* are unlikely to be resampled in the SIR process). It was noted that while importance functions would help improve sampling efficiency, caution needs to be taken since the true distributions for the stock distribution parameters are not known, and overly narrow importance functions can lead to numerical instabilities. It was suggested that utilising an importance function for the BSD growth rate parameter might be an easier avenue to improve sampling efficiency, although another option would be to sample the γ^* parameter from the interval [0.2,1] instead of [0,1] as virtually no values between [0,0.2] were resampled.

It was noted that the N_{min} constraint is imposed as a hard boundary (ie. the population trajectory may not go below the constraint).

3.1.2.2 INVESTIGATION OF GENETIC DATA TO INFORM ANTARCTIC FEEDING GROUND CATCH BOUNDARIES

The allocation of catches from longitudinal feeding ground sectors to particular breeding stocks was highlighted as a continuing problem for the original three-stock model, and investigations of the ratios of breeding stock genetic signatures within feeding ground biopsy samples were suggested to resolve these catch allocation issues, although it was noted that using fine scales for such longitudinal sectors may be limited by biopsy sample size.

Stock distribution proportions of BSD, BSE1 and BSO breeding stocks in the Antarctic feeding grounds were calculated for the catch allocation boundaries used in the three-stock model based on the assumed pure genetic signatures from stocks BSD ($n=185$), BSE1 ($n=104$) and Oceania ($n=601$) within 1,057 feeding ground biopsy samples obtained during JARPA/JARPAII and IWC IDCR/SOWER surveys over the period 1990's-2010/11 (Pastene *et al.*, 2013). These stock distribution proportions are provided in Appendix 2, Table 1b (null values reflect assumed zeros rather than the stock distribution proportions being calculated over the three feeding ground intervals) while the availability of biopsy samples by 10 degree longitudinal slice is provided in Appendix 2, Table 2. Comparisons of the stock distribution proportions from the three-stock model run (utilising the BSO N_{min} value set as $3*33$) (1) where the model was fitted directly to genetic stock distribution proportions with the likelihood of comparing to model outputs over the same period as for sample collection, and (2) where the model was not fit to the stock distribution proportion data directly to the stock distribution proportions provided by the genetic data. Whilst concordance in the comparisons of mixing proportions of BSD was obtained in core D and E1west areas, there was not a good match for BSE within the E1east and the core O areas, even when the model was fit to the genetic data, which may reflect incorrect specifications of catch boundaries or incorrect pure stock signature assumptions. The movement of feeding area boundaries was proposed to investigate this and both shifts of the 130°E E1east/E1west boundary and the 170°E E1east/core O boundary were identified, with the following options being prioritised.

- (1) A twenty degree eastward shift of the 130°E E1east/E1west boundary to 150°E with a corresponding ten degree shift in the 170°E E1east/core O boundary to 180°E.
- (2) A ten degree eastward shift of the 130°E E1east/E1west boundary to 140°E with a corresponding ten degree shift in the 170°E E1east/core O boundary to 180°E.
- (3) A ten degree shift in the 170°E E1east/core O boundary to 180°E with no shift in the 130°E E1east/E1west boundary.

Comparisons of the stock distribution proportions resulting from these shifts of feeding ground boundaries showed poorer agreement than the base case result, and the shifting of the feeding ground boundaries made little difference to the model outputs. It was suggested that the feeding ground boundary shifting be disregarded.

It was noted that biopsy sampling was generally opportunistic and neither random across feeding areas nor proportional to population sizes. The investigation of the mixing proportions may be achievable over 10° longitudinal sectors over the certain areas of the feeding grounds where a large number of biopsy samples are available. The comparisons of stock distribution proportion results from the model outputs with pure genetic signatures of the three breeding Stocks by 10 degree or wider longitudinal interval were carried out both as two stock BSD/BSE comparisons over the 35°E to 130°E longitudes and BSE/BSO over the 130°E to 120° W longitudes) and three stock comparisons in each of the intervals over the 35°E to 120°W). The extent of the BSO signature within 10 degree longitudinal sectors to the west of 130°E was evident, although it was noted that the confidence intervals of some of the stock distribution proportions were very wide.

Some discussion was held on reliability of the breeding stock genetic signatures assumed. The effect of sample sizes was raised in that there may be under-sampling in BSE1 compared to BSO. In response it was suggested that the dilution of the BSO signal may arise through admixing of BSE1 individuals to BSO within New Caledonia and the exclusion of New Caledonia samples within the BSO signature was suggested, but not agreed to by the sub-committee. It was further noted that the biopsy samples from BSE1 used in the stock distribution proportion analyses were collected on the migratory corridor rather than on the true breeding ground. Although there are relatively few samples from the Great Barrier Reef breeding area, samples collected from further north on the breeding grounds such as near or in Hervey Bay may be more representative.

Asymmetry of sample sizes would impact results, in that larger sample sizes would result in more shared frequencies. Whilst the current method of identifying breeding stock signatures assumes exactness and then identifies proportions within the feeding grounds, it was noted that an alternative estimation procedure based on full likelihoods would take the skewness in sample sizes into consideration.

3.1.2.3 ALTERNATIVE THREE STOCK MODEL

Removal of the 110°E and 170°E feeding-ground boundaries provided an alternative three-stock model (see Fig. 3) in which only one stock distribution parameter (γ) needs to be estimated. Whilst the original three-stock model is biologically more plausible, the number of replicate samples required in the SIR process to estimate the 6 mixing parameters was problematic. Runs of the model with the boundaries removed showed parameters to be relatively well estimated, with little difference between the sensitivity runs with and without an N_{min} constraint.

In response to a question that an estimate of the relative abundance for BSE1 fell outside of the 90% probability envelope of the model results, it was noted that the inclusion of a confidence band for the relative abundance data point results in

congruence with the model fit. Furthermore, it was noted both that the fits of the Chittleborough relative abundance data were good and that this model better fitted the 9% increase rate for BSD noted earlier from field data. An additional consideration was that the sampling intensities of the algorithm required for the multiple stock distribution parameters in the original three-stock model may be problematic.

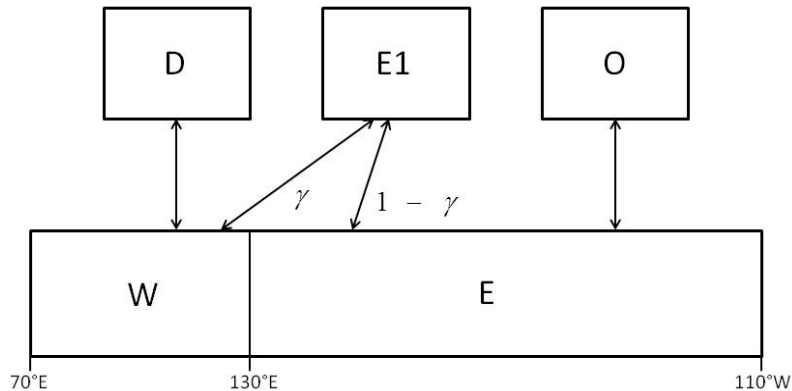

Fig. 3. Diagrammatic representation of the alternative three-stock model developed by the sub-committee.

It was **agreed** that further work should be undertaken to try to improve the sampling efficiency of both the original and alternative model. However, the use of importance functions did not improve the sampling efficiency for the original model and the stock distribution parameter remained poorly estimated. As such, it was proposed to the sub-committee that the simpler, alternative model should be used as the base case model, although time-permitting, a formal statistical comparison of the results of the two models would be attempted. The same sensitivity runs of Antarctic stock sensitivity proportions and N_{min} would need to be applied to the alternative model as was done for the original model, along with a series of further sensitivity runs.

- (1) Shifting of the Antarctic catch boundaries (as shown in Fig. 3).
- (2) Modifying the bounds for the BSD absolute abundance estimate.

The lower bound on BSD abundance provided by Hedley resulted in good model fits, but it was agreed that further sensitivity analyses exploring values greater than 15,000 would be valuable since those would be more in line with the original abundance value suggested in Hedley *et al.* (2011). Sensitivities were run on modifying:

- (a) the lower bound from 15 000 to 18 000 (i.e. $U[\ln 18\ 000, \ln 40\ 000]$) for the log of the target estimate;
 - (b) the lower bound from 15 000 to 20 000 (i.e. $U[\ln 20\ 000, \ln 40\ 000]$) for the log of the target estimate; and
 - (c) the upper bound from 40 000 to 30 000 (i.e. $U[\ln 15\ 000, \ln 30\ 000]$) for the log of the target estimate).
- (3) Alternative treatment of the breeding ground catches.

The allocation of New Zealand catches to BSE1 and BSO in SC/65b/SH04rev had been questioned. Despite any misallocations of low latitude New Zealand catches being small and unlikely to influence results, it was proposed that the catch allocation be revised for future model runs so that:

- (a) New Zealand catches are split in proportion to the BSE1 and BSO population sizes; and
 - (b) New Zealand catches are allocated to BSO.
- (4) Augment the Noad *et al.* (2011) relative abundance data for BSE1 with the Forestell *et al.* (2011) mark-recapture data in the model fit.

Although time constraints prevented a Bayes Factor statistical comparison of the models, the better fit of the alternative single interchange model resulted in the sub-committee accepting the proposal that the alternative model become the base case model.

3.1.3 Final assessment model results

Final assessment results and sensitivity runs are provided in Appendix 3. Table 1 and Table 2 summarise the model inputs and results for the base-case model, respectively. The sub-committee noted that the results of the model runs did not vary appreciably under the different sensitivity scenarios, except if the minimum of the prior for the BSD absolute abundance in 2008 was increased appreciably.

In response to a question of catch allocation boundaries, the sub-committee was reminded that these have not always aligned with IWC Management Area boundaries.

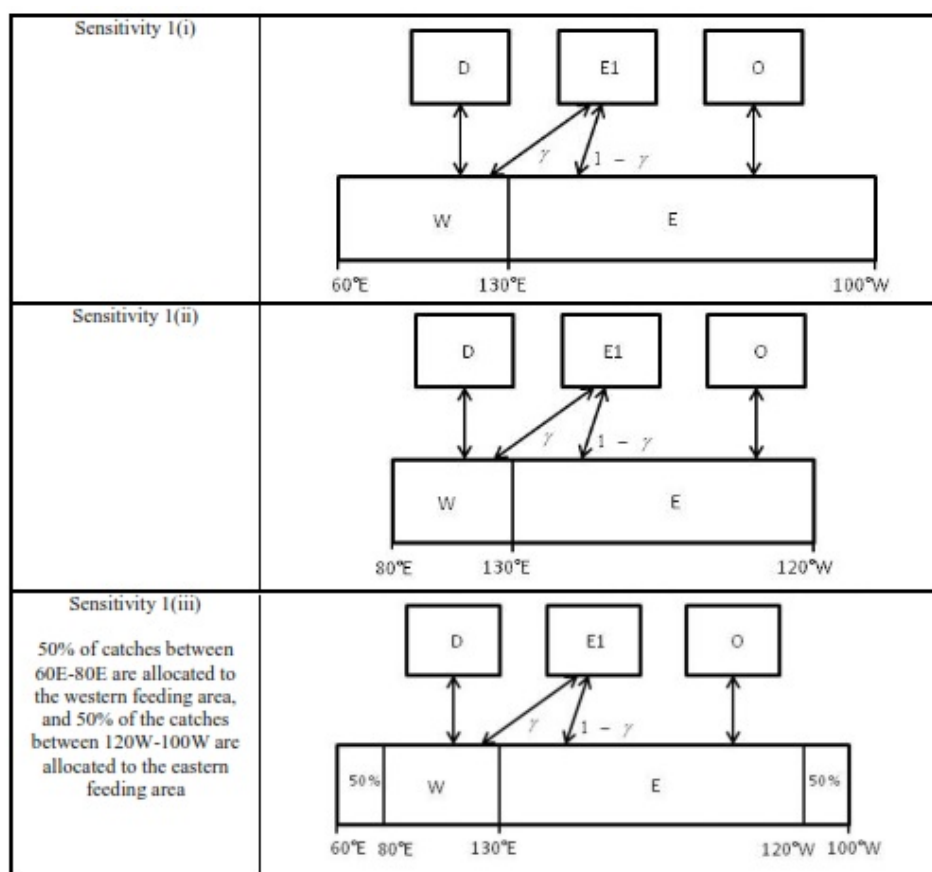

Fig. 3. Diagrammatic illustrations of the alternative Antarctic catch boundaries that were explored in the catch allocation sensitivity runs.

In reviewing the results of the prior assessment of BSD (IWC, 2007), the sub-committee noted a striking similarity to current BSD model outputs. It concluded that it would be valuable to update the 2006 single stock model to more directly compare to the results of the three-stock model used in the current assessment. In response to a question on what catch allocations had been made in the 2006 Fringe model (particularly what percentages of catches had been apportioned to the Fringe areas), it was clarified that 100% of catches from 50°E-130°E were allocated in that model. Conclusions drawn from current assessment results in the context of the previous BSD assessment are discussed further below (Item 3.1.4).

Table 1. Summary of specifications of the base case model run.

	BSD	BSE1	BSO
r prior	U[0,0.106]	U[0,0.106]	U[0,0.106]
Historic catch	Feeding ground catches between 70E-130E split in proportion to abundances	Feeding ground catches between 70E-130E, and between 130E-120W split in proportion to abundances. Breeding ground catches from NZ split in proportion to BSE1 and BSO abundances.	Feeding ground catches between 130E-120W split in proportion to abundances. Breeding ground catches from NZ split in proportion to BSE1 and BSO abundances.
Recent abundance	-	14522 (CV 0.065) Noad <i>et al.</i> (2011)	-
Trend information	Bannister and Hedley (2001) and Hedley <i>et al.</i> (2011)	Noad <i>et al.</i> (2011)	-
Mark-recapture	-	-	Constantine <i>et al.</i> (2011)
Nmin constraint	>3*27	>3*5	>3*33

Table 2. Posterior median values of key model parameters for the base case model with 90% probability intervals in brackets.

	BSD		BSE1		BSO	
r	0.090	[0.053,0.104]	0.105	[0.103,0.106]	0.091	[0.071,0.101]
K	21686	[19016,29383]	26133	[21605,29033]	14115	[10198,19651]
γ	-	-	0.068	[0.007,0.190]	-	-
N_{min}	824	[461,3685]	237	[203,272]	132	[103,250]
N_{2012}	19264	[17553,24012]	16366	[14674,18034]	5072	[4456,6040]
N_{min}/K	0.039	[0.023,0.128]	0.009	[0.008,0.011]	0.010	[0.007,0.014]
N_{2012}/K	0.904	[0.739,0.984]	0.634	[0.561,0.729]	0.371	[0.238,0.535]
N_{2020}/K	0.984	[0.883,0.998]	0.915	[0.872,0.950]	0.648	[0.409,0.846]
N_{2040}/K	1.000	[0.991,1.000]	1.000	[0.999,1.000]	0.993	[0.926,0.999]

3.1.4. Conclusions and recommendations

The posterior median estimate of population status in 2012 relative to pre-exploitation abundance suggest that BSD is approaching pre-exploitation levels (90%, 90% probability interval (PI) = 74-98%). However, the results are somewhat sensitive to the lower bound on BSD absolute abundance estimates for 2008, with greater abundance resulting in a slightly greater level of recovery. Given that the available lower bound estimate was preliminary, future work was **recommended** to further refine that value.

The sub-committee noted that an assessment of BSD was completed in 2006 and had concluded that there had been a substantial increase since protection (IWC 2007). However, it was agreed at that time that the assessment modelling results should be considered preliminary and re-evaluated in the future. It was anticipated then that re-assessment would require clarification of the stock structure of Oceania and the extent of mixing at high latitudes, as catch allocation would perhaps be influenced by mixing with BSE. The three-stock models presented in the current assessment address the concerns expressed previously by allowing for mixing of neighbouring breeding stocks in the Antarctic feeding areas. Although direct comparisons between the two assessments should be viewed with caution due to differences in model inputs and assumptions, the results of the 2006 Fringe model for BSD are very similar to the current base case assessment (Appendix 3).

The base-case three-stock assessment results for BSE1 and Oceania were not sensitive to the assumption of BSD abundance and suggested the levels of recovery towards pre-exploitation levels to be 63% (90% PI = 56-73%) and 37% (90% PI = 24-54%), respectively.

The sub-committee noted that the current assessment of BSO was valuable in terms of understanding the broader aspects of population status. However, complexities in Oceania require further investigation due to inadequate stock structure definition across the broad area, a lack of population trend data for most of the region, and a lack of resolution and understanding of connectivity in eastern Oceania.

The sub-committee had discovered some significant differences (particularly for Oceania) between the high latitude catch allocations that best fitted the BSD/BSE1/BSO three-stock population model and the results of a mixed-stock analysis allocating high latitude mtDNA samples to low latitude breeding grounds. Further work on genetic mixing proportions was considered valuable for comparison with model outputs, although such comparisons were considered unlikely to alter the outcome of this assessment appreciably.

In view of this, an intersessional email group was **recommended** to discuss and resolve the current sampling and analytical limitations of this approach. Aspects to be discussed and evaluated include: 1) sample sizes collected from breeding grounds and their influence on mixing proportions (*i.e.* allowance in the estimation for imprecision in the estimates of genetic frequency distributions for breeding stocks); 2) population substructure in Oceania and the impact of combining versus using individual stocks on catch allocation; 3) some possible stratifications of the 'pure' breeding stock samples to test alternate composition of 'pure' stocks (particularly with respect to East Australia); 4) developments of the likelihood model to account for unsampled haplotypes.

In conclusion, the sub-committee **agreed** that its assessment of breeding stocks BSD/BSE1/BSO had been completed. It acknowledged the efforts of all those who helped to bring the assessment to a conclusion. Particular thanks were extended for the analytical work provided intersessionally and in the meeting by Butterworth, Hedley, Jackson, Kitakado, Pastene and Ross-Gillespie. The data providers specified in SC/65b/SH04rev Table 1 were also gratefully acknowledged, as well as the South Pacific Whale Research Consortium. The sub-committee expressed its appreciation for the use of facilities provided by the University of Cape Town's High Performance Computing team, without which it would not have been possible to perform the key assessment computations conducted.

3.2 Review new information

3.2.1 Breeding stocks D/E/F

Polanowski *et al.* (2014) reported a new epigenetic technique for estimating humpback whale age from biopsy samples. Age-associated DNA methylation in human and mouse genes were used to identify homologous gene regions in humpbacks whales. Humpback whale skin samples were obtained from individuals with a known year of birth and employed to calibrate relationships between cytosine methylation and age. The resulting assay has an R^2 of 0.787 ($p = 3.04e-16$) and predicts age with a standard deviation of 2.99 years. It was also found to correctly order parent-offspring pairs in more than 93% of cases. As an example application of this technique, age was estimated for 63 samples available from East Australia in 2009 and compared to age profiles for the same population from 1952-1962. Although several caveats were noted, the authors concluded that the high apparent proportion of young animals in 2009 was interesting and warrants further study. The availability of a technique to age individuals from skin samples will allow future systematic studies of age structure as well as improved understanding of population dynamics.

In discussion, it was clarified that the method can be applied to material collected previously and therefore has considerable potential for archived datasets.

SC/65b/SH07 reported on genetic sampling of humpback whales from Cook Strait, New Zealand. Historically humpback whales migrating past New Zealand have been linked to the east Australia migratory corridor, western South Pacific breeding grounds and IWC Antarctic Area V feeding grounds. Due to the largely opportunistic nature of sightings, to date

most studies have analysed small datasets. In this study, 211 samples were collected between 2003 and 2010 and the 190 DNA profiles that passed quality control represented 167 unique whales. Comparison to Oceania (n=1,052 individuals) and east Australia (n=865 individuals) DNA registers revealed six matches to New Caledonia and five matches to east Australia. There were no matches to any other Oceania region. This study shows that humpback whales passing New Zealand on their northern migration show the least genetic difference to New Caledonia. However, they do not appear to show the same fidelity to the migratory corridor as they do to the breeding grounds. The low rate of between-year resightings and matches to east Australia suggest variability in the use of migratory corridors. Possible connections to an east Australian breeding ground in the Great Barrier Reef could not be explored fully due to a lack of data from this area, but this would be of interest in the future given the level of matches to the east Australian migratory corridor.

Discussion of these results in the context of stock structure can be found in the report of the Working Group on Stock Definition (Annex I). The sub-committee noted that these results are consistent with model assumptions in the assessment of BSD/BSE/BSO.

SC/65b/SH10 introduced a new crowd-sourcing website, *Match My Whale*, which encourages citizen scientist users to score humpback whale fluke photos and search for matches among two donated photo-identification catalogues: Pacific Whale Foundation's East Australian catalogue and the Centre for Whale Research's West Australian catalogue, and among user-uploaded fluke photographs. The authors theorised that this online citizen scientist fluke matching platform will be more effective than the current method(s) of manually searching for a match, or relying on complicated computer software. The authors acknowledged funding from the Australian Marine Mammal Centre.

Discussion of this paper by the sub-committee focussed on the potential value of this project to harness the tremendous public interest in humpback whales, and particularly matching humpback whales on-line.

Orgeret *et al.* (In review) provided information on the population growth rate of humpback whales at New Caledonia. The Pradel model was used as it produces direct estimate of the growth rate, and unlike growth rates derived from Leslie projection matrices, it is independent of any demographic scenario. Rather, it directly reflects the actual population growth rate experienced by the population during the survey period and is thus relevant to assessing the population trend and status. Simulations demonstrated the robustness of the model to the presence of transients and in the case of unequally sampled areas. The best model was set with constant survival but probability of detection variable over the years. The results indicated a constant yearly growth rate at 1.15 [1.11; 1.20]. This value is much higher than the maximum rate of increase for humpback whale populations (11.8%, Zerbini *et al.* 2010), but the realised growth rate incorporates the effect of migration as well as that of demography. While the best model indicates a constant rate of increase, a recent abundance study had found an anomalous increase between 2008 and 2011. The authors hypothesised that the local increase at New Caledonia could be due to a redistribution of individuals within the region. Immigrants from Fiji could be responsible for part of the immigration, as that population does not show signs of recovery. On the other side, the eastern Australian population has shown a strong rate of increase (10.9%) for several years and could also act as a source of immigrants for the New Caledonian population. To date, limited exchange between the east Australian population and Oceania have been documented using photo and genotypic identifications. However, a certain degree of interconnectivity has been demonstrated with the cultural transmission of the song from the east Australia eastwards through Oceania. New Caledonia is the closest island in Oceania to Australia and most likely to receive immigrants and individuals en route to farther grounds.

The sub-committee welcomed this paper and commented that analyses of this nature are important for understanding the effects of movement on estimates of population parameters.

3.2.2 Breeding stock G

SC/65b/SH15 provided an update on humpback whale research in the Gulf of Chiriqui, western Panama, for 2013. Previous studies have shown that the Gulf of Chiriqui (located at ~8°N) is an important reproductive area for Breeding Stock G (Rasmussen *et al.* 2007, SC/65a/SH04). This area is unique because it harbours the northernmost breeding area of any Southern Hemisphere humpback whale population (with whales migrating ~ 8,300km from the feeding areas), and is also used by whales migrating from feeding areas off California-Oregon-Washington in the Eastern North Pacific between December and April. This is the only known breeding area in the world that hosts two populations from distinct hemispheres (Rasmussen *et al.* 2012). In 2013 the authors continued long-term monitoring efforts, based out of the Secas Islands. Compared to previous years, 2013 had greater encounter rates (whales/km surveyed), larger group sizes, and more photo IDs collected. Combined, these results indicate that many more whales visited the Gulf of Chiriqui in 2013. The authors offer initial speculations that this could be due to a shift in habitat use, an increase in population size, survey biases, or possibly a combination of all these factors. They highlighted the importance of continuing these annual monitoring efforts to determine if the encounter rates and group sizes in 2013 are part of an on-going trend for this population. Monitoring is also important for documenting how environmental conditions influence the patterns of humpback whale occupation and population trends for BSG, especially considering that a strong El Niño event is expected in 2014-2015.

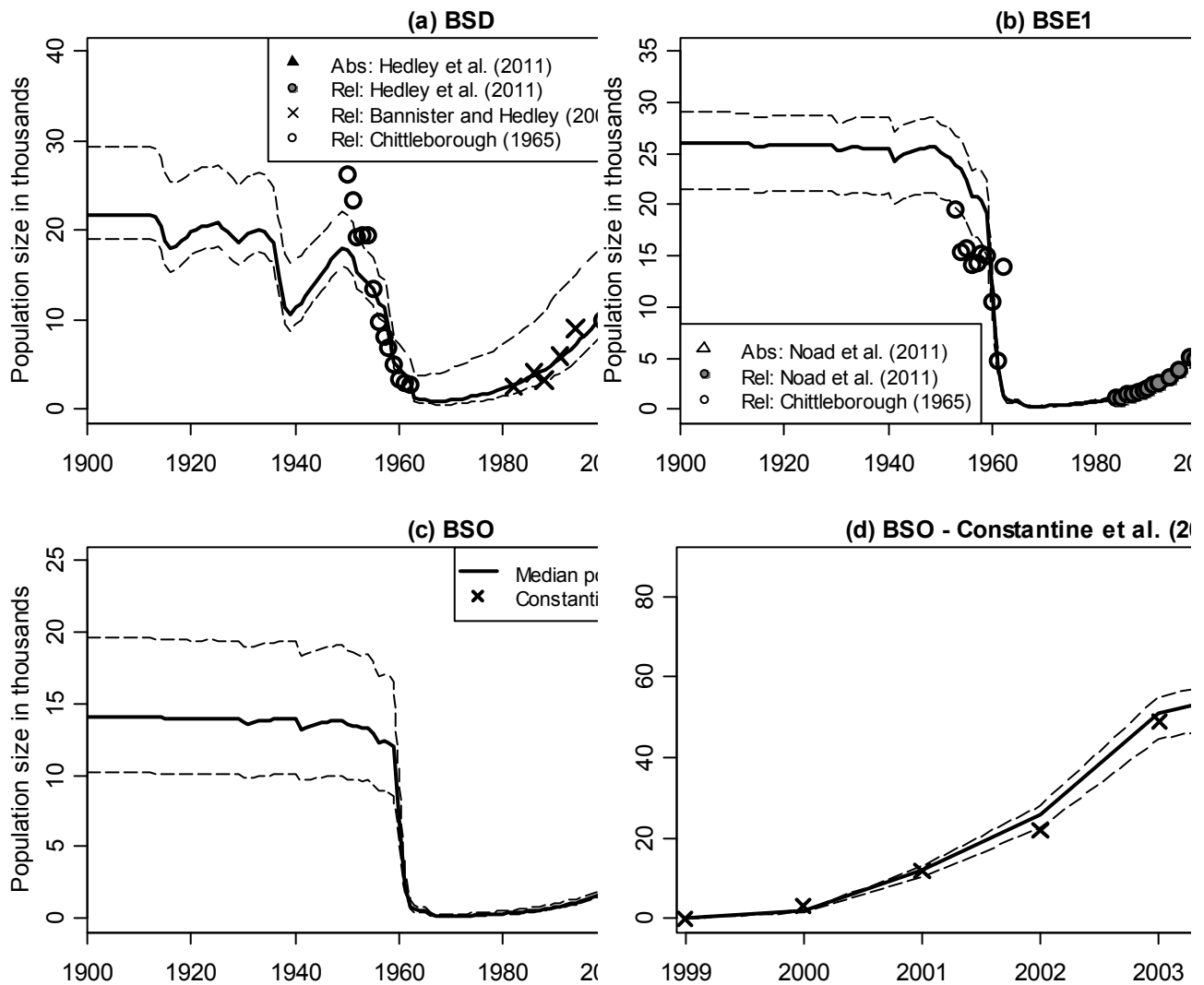

Fig. 4: (a)-(c) show the median population trajectories for the base case three-stock model. 90% probability envelopes are indicated by the dashed lines. The model is fit to the Bannister and Hedley (2001) and the Hedley *et al.*(2011) relative abundance series for BSD (fits shown in Fig. (a)); the Noad *et al.* (2011) absolute and relative abundance series for BSE1 (fits shown in Fig. (b)), and to the Constantine *et al.* (2012) mark-recapture data for BSO (Fig. (d)). In Fig. (d), the cumulative observed re-sightings are marked by X's. Fits to the Hedley *et al.* (2011) absolute abundance estimate (Figure (a)); the Chittleborough (1965) relative abundance series (Fig. (a) and (b)); and the Constantine *et al.* (2012) absolute abundance estimate (Fig. (c)) are shown as consistency checks.

The sub-committee commented that genetic studies would be of particular interest given the use of this breeding ground by Northern Hemisphere animals, as well as by individuals from different Southern Hemisphere feeding aggregations.

3.2.3 Breeding stock C

The study presented in Fossette *et al.* (2014) was discussed in SC/65a. The authors were thanked for making the published paper available.

3.2.4 Breeding stock B

Rosenbaum *et al.* (2014) dealt with the movement of BSB humpback whales and their overlap with anthropogenic activities in the South Atlantic Ocean. It sought to better understand humpback whale habitat use and movements at breeding areas off West Africa, and during the annual migration to Antarctic feeding areas. Habitat use was quantified for 3 cohorts of whales tagged off Gabon and a state-space model was used to determine transitions in the movement behaviour of individuals. Strong heterogeneity in movement behaviour over time was detected that is consistent with previous genetic evidence of multiple populations in the region. Breeding areas for humpback whales in the eastern Atlantic were extensive and extended north of Gabon late in the breeding season. Also observed, for the first time, was direct migration between West Africa and sub-Antarctic feeding areas. The potential overlap of whale habitat with human activities was discussed in the Environmental Concerns Standing Working Group.

3.2.5 Feeding grounds

SC/65b/SH05 provided an update of the CETA project which was carried on the continental shelf off Adélie Land, in the IWC Area V between 65-66°S and 140-145°E. The aim of the project is to assess the distribution patterns and relative

abundance of cetaceans. Opportunistic surveys conducted in January 2010, 2011 and 2014 resulted in a sampling effort of 304h42, of which 207h48 were conducted in line transects, 77h30 during fixed stations and 19h24 from a semi-inflatable boat provided by the Australian Antarctic Division. Humpback whales represented 14% of the sightings, most occurring over the slope of the continental shelf. One photo-identified humpback whale was first sighted in January 2010 and matched to an individual observed on the east coast of Australia in 2002 and 2008. Three biopsy samples were collected from humpback whales, but did not genetically match 2,353 samples available from Oceania and Australia. This work is a part of IWC-SORP and contributes to the knowledge of cetaceans using non-lethal research techniques and extends the data available in the region. The sightings will be combined with environmental data to identify biological and physical ocean features that favour the presence of whales in this region.

SC/65b/SH16rev reported on data collected from visual and acoustic observations from the Argentinean vessel *Tango SB-15* in Antarctic and sub-Antarctic waters during a SORP research cruise in February 2014. During 13 days of active sighting effort, 153 hours of on-effort observations covered 1,331 nautical miles. Totals of 211 visual sightings (90% were mysticetes and 10% were odontocetes) and 17 acoustic detections included at least 11 identified cetacean species. Humpback whales were the second most encountered cetacean, and had the highest mean encounter rate 0.252 ± 0.078 whales/nm in the western Antarctic Peninsula. Humpback and minke whales were more concentrated in the western Antarctic Peninsula in shallower waters, near islands and close to shore.

Zerbini presented SC/65b/SH18 on behalf of the authors. This paper reported estimates of abundance and trends of humpback whales in the Magellan Strait, southern Chile. This is one of the most important international shipping lanes in the Southern Hemisphere that is used primarily by container vessels and tankers. The region is characterised by narrow canals and passes, where the effective navigational channel is less than a mile wide in some places. The strait is also a highly productive ecosystem and is one of the feeding grounds associated with the BSG. This population has been the subject of photo-identification studies since 2003. A Bayesian mark-recapture robust design model was used to estimate abundance and trends for this population between 2004 and 2012. The most recent abundance indicates a population of 88 individuals in the region. The estimated median trend over the whole study period indicated a 3.2%/year increase but the median trend over the past seven years is close to zero. These results indicate this population is likely small and appears to be stable.

The authors were not present for a detailed discussion of the paper, but ship-strike components were discussed by both the Working Group on Non-deliberate Human-induced Mortality of Large whales (Annex J) and the Standing Working Group on Environmental Concerns (Annex E). In response to a question, it was noted that the estimated survival rate was lower than is typical in other humpback populations and it was discussed that transience in the data set could explain this low value. Although photo-identification efforts were believed to span the feeding ground, early coverage may not have done so and that this may be reflected in the lower abundance estimates early in the time series. It was suggested that a discovery curve would be a valuable addition to these analyses. The sub-committee welcomed and **encouraged** the continuation of this study.

SC/65b/IA10 reported on circumpolar spatial distribution of humpback whales using the IDCR/SOWER CPII and CPIII data. A generalised additive model (GAM) having a Tweedie error distribution with a logarithmic link function was used to estimate the relative abundance. Effective search width and mean school size estimated by Branch (2011) were used in the analysis. Sighting effort and sighting data were aggregated into 30 by 30 km grid cells and number of animals in these cells was used as a response variable. Because environmental data at the time of the surveys were not available especially in early years of the IDCR/SOWER, publicly available climatological data (Raymond 2012, updated 2013) were used in the analysis. Explanatory variables were selected based on values of variance inflated factor (VIF) before the GAM modelling to minimise effect of co-linearity among the variables. Selected variables and shapes of smoothed fits were different between CPII and CPIII. The results could reflect that suitable environmental conditions for humpback whale were different in the different region of the Antarctic. The difference of shapes of smoothed fits between CPII and CIII could also indicate changes of suitable environmental conditions for humpback whales as the abundance was increased from CPII to CIII. The estimated spatial distribution of humpback whales from CPII to CPIII was expanded.

3.3 Antarctic Humpback Whale Catalogue

SC/65b/SH03 presented the interim report of the IWC Research Contract 16, the Antarctic Humpback Whale Catalogue (AHCW), an international collaborative project investigating movement patterns of humpback whales in the Southern Ocean and corresponding lower latitude waters. During the contract period, the AHCW catalogued 761 photo-id images representing 614 individual humpback whales submitted by 21 individuals and research organisations. Matches made during the contract period to previously sighted individuals include re-sightings between BSG and the Antarctic Peninsula (18) and between BSG and the Chilean feeding area (3). Within-region re-sightings were identified in BSC3 (2), BSG (18) and the Antarctic Peninsula (7). Due to the long nature of the project, now spanning three decades, a number of individuals identified during the contract period were re-sighted to some of the earliest records in the database, adding substantially to the number of individuals with long sighting histories. These included six of the nine individuals in the collection with sighting spans exceeding 20 years. Two individuals with 28 year sighting histories, the longest in the database, were identified during the contact period; sixty-eight individuals had re-sightings spanning ten years or more. The fluke photographic collection has approximately doubled in size in the past five years, and now consists of 9007 photographs of 5,923 individual whales. The right dorsal fin/flank collection consists of 522 photographs of 414

individuals. The left dorsal fin/flank collection consists of 503 photographs of 409 individuals. Progress continues in efforts to stimulate submission of such opportunistic data from eco-tourism cruise ships in the Southern Ocean and from research organisations and expeditions working throughout this region and the Southern Hemisphere. For the period 1981 through 2014, 1,058 individuals have been identified from ecotourism and other opportunistic sources and have broadened understanding of the exchange between areas and in some cases provided information that was previously not available. The AHWC provides a unique clearing house for these opportunistic data, facilitating public education and participation, and providing a valuable source of data to researchers for scientific analysis.

The sub-committee has supported the valuable work of the AHWC in the past and **strongly endorsed** its continuation. This is an item with financial implications (see Item 7.1).

Kaufman reported that the Pacific Whale Foundation would be making a substantial contribution to the catalogue of photo-identification data from Ecuador in 2014.

3.4 Status of the assessment of Southern Hemisphere humpback whales

With the completion of the assessment of BSD/BSE1/BSO the subcommittee **agreed** that the Southern Hemisphere humpback whale Comprehensive Assessment had been concluded. Assessments of BSA (Western South Atlantic Ocean), a preliminary assessment BSD (Eastern Indian Ocean) and BSG (Eastern South Pacific Ocean) were completed in 2006 (IWC, 2007), while assessments of BSC and BSB had been completed in 2009 (IWC 2010) and 2011 (IWC 2012), respectively. Noting that this circumpolar assessment took eight years to complete, the subcommittee **recommended** that a synthesis of the assessment results and unresolved questions be undertaken. This would be best initiated intersessionally and a plan for this work is outlined in item 7.1.

4. ARABIAN SEA HUMPBACK WHALE POPULATION

4.1 Review new information

SC/65b/SH19 reported on preliminary results and first insights from satellite tracking studies of male Arabian Sea humpback whales from Oman. In February this year the Oman research group worked with guidance of a tagging expert group with the objective of deploying 6 satellite tags. Fieldwork participants also included researchers with longstanding experience on the project as well as researchers from other range states including India, Pakistan and Iran. Five whales were tagged over a three week period at a field site in southern Oman. Weather constraints, as well as an extreme sensitivity of targeted whales to the tagging boat proved to be major challenges for tag deployment efforts. Two tags implanted poorly returning very little or no data suggesting that they detached fairly soon after deployment. However three tags provided good locations for several weeks. Although admittedly these results arise from a small sample size, the whale track plots correspond with previous modelling work produced from boat-based sightings data (Corkeron *et al.* 2012) and confirm the value of this research approach to realise and evaluate opportunities for mitigating threats. Further and more detailed analysis is expected after a follow up season of tagging in 2015 in which we propose to relocate tagging operations to the Gulf of Masirah in April. This will allow tagging to occur when resightings of individuals are lower and at a time closer to the southeast monsoon, when vessel work is usually curtailed by sea-state. The spatial ecology of this sub-population continues to be poorly understood across the rest of its range and we propose that efforts such as tagging continue to be incorporated as part of on-going research strategy development in the region.

In response to a query, the authors clarified that three tagged whales had been resighted within days of tagging and that no health effects were apparent at that time. Two of the tagged whales had been singing prior to tagging and recommenced singing within 15 minutes of the tag placements. It was further reported that the involvement of participants from other ASHW range states in the tagging programme was important in the development of cetacean research programmes in other areas of the Arabian Sea. The sub-committee noted the value of this work and **strongly endorsed** its continuation.

4.2 Progress toward the development of a Conservation Management Plan and other conservation initiatives

It was reported that a recent informal meeting of researchers from the Arabian Sea had advanced ideas on future research directions on humpback whales in the region. Willson reported on this progress towards the Regional Conservation Initiative on the Arabian Sea Humpback Whale Population. Reference was made to SC/65a endorsements of plans for the development of a regional conservation initiative for the ASHW, given its IUCN 'Endangered' listed status and limited knowledge and capacity throughout its range. It was reported that during the last year a consortium of NGO's and active researchers in the region had developed an agenda to facilitate further work, part of which is a workshop funded by the US Marine Mammal Commission and WWF. This workshop will facilitate capacity building of research personnel and prioritisation of activities towards conducting surveys into areas considered to be hotspots. Further assessment of escalating threats will also be evaluated. The consortium stressed the importance of securing support to follow up intersessionally, with activities already identified and workshop-related tasks, including the priority tasks of genetic analysis of existing unanalysed samples, field survey training, and preliminary surveys in the Gulf of Kutch on the Pakistan-India border.

The sub-committee welcomed these ongoing efforts to develop regional cooperation for research and capacity and **recommended** the priority tasks listed above. This recommendation has financial implications, as described in Item 7.1.

In response to a question on the accessibility of the Gulf of Kutch and its trans-boundary nature, it was noted that project partners had established programmes in Pakistan and so efforts would best be initiated from the Indian area of the Gulf.

The status of the IWC Arabian Sea Humpback Whale Conservation Management Plan was raised and it was noted that such a plan requires introduction by within-country commissioners (in this case, from either India or Oman). Attempts to initiate this had been ongoing for a number of years, although there has been national support of ongoing research and training initiatives within Oman. The sub-committee noted that the proposed workshop provides the building blocks required for the CMP process.

The sub-committee **reiterated** its serious concern about the status of the endangered status and threats of this distinct population. A regionally coordinated conservation and research program was **strongly recommended** and the sub-committee urged IWC Commissioners to consider the nomination of the Arabian Sea humpback whale for a CMP. The sub-committee encouraged the engagement of range states in the CMP process, given the benefits that a regional framework will provide. The sub-committee also suggested that the issue be reviewed by the Conservation Committee, with the continued support of the intersessional Arabian Sea working group.

5. ASSESSMENT OF SOUTHERN HEMISPHERE BLUE WHALES

5.1 Review new information

5.1.1 Antarctic blue whales

5.1.1.1 CRUISE REPORTS

SC/65b/SH01 reported on the South African National Antarctic Programme (SANAP) 2013/2014 cruise to the 000° - 020°E Antarctic coastal region, during which two research objectives were undertaken. An Autonomous Acoustic Recorder (AAR) Mooring was deployed in on the Maud Rise. This AAR will record until February 2015 when the mooring will be recovered and in all likelihood be re-deployed for a further year. A line transect survey cruise track (out to 60 n. miles from the ice-edge between 000°E and 020°E) was carried out over 13 – 22 January, although poor sighting conditions resulted in the decision to terminate the survey at 017°30' E. A total of 82 hours (859 n miles) and 11.9 hours (139 n miles) of survey effort was carried out during the line-transect survey and the transits to and from the survey area respectively, with a further 40.3 hours spent confirming and closing on whale groups and 27.5 hours spent drifting in conditions unsuitable for survey. A total of 214 sightings of an estimated 453 cetaceans were sighted during the research effort on the survey. Seventeen groups of 26 blue whales were encountered on the cruise, with one sighting of two individuals made during research effort by other observers and two sightings of two individuals made outside of research effort. Based on their body shape, all blue whales were identified as Antarctic blue whales (*B. m. intermedia*). Blue whale sightings appeared to be aggregated in three areas around 007°30', 010° and 015°E. Approaches of blue whale groups were carried out by the small boat or the *SA Agulhas II* on eight and five occasions respectively. Biopsies were collected from four individual blue whales, while at least 16 blue whales are believed to have been adequately photographed for identification purposes. Calibrated echo-sounders were operated from the *SA Agulhas II* to survey whale prey species to allow whale densities to be correlated to prey and productivity indices. The relatively high numbers of blue whales sighted on this survey re-enforces the perception that the 000-020°E region of the Queen Maud Land coast is a hotspot for Antarctic blue whales.

The authors of SC/65b/SH01 were congratulated on the blue whale results from this cruise. In response to a question on the active acoustic surveys of krill, it was noted that these surveys included ichthyoplankton net trawls to provide length frequencies of prey species within adequate acoustic targets. The availability of the resulting photo-identification and genetic biopsy data to the IWC-SORP databases was questioned, and Findlay responded that in the longer term these data would be available to these databases, but that commitments to students precluded their immediate open release. It was noted in discussion that such circumstances can be facilitated through data-sharing agreements. In response to a comment that the IWC-SORP had operations protocols for small boat work in Antarctic waters, it was noted that the small boat experience on this cruise could inform these protocols.

SC/65b/SH05 reported on six sightings of Antarctic blue whales plus four 'blue-like' whales that were recorded during the CETA project (7% of the total sightings made). Blue whales were sighted at the edge of the continental slope and in the Adélie depression. Three of the animals were individually photo-identified, one of which was re-sighted during the IWC-SORP Antarctic blue whale voyage in the Ross Sea region.

SC/65b/SH16 reported that a single blue whale was seen on one occasion on the Argentinean IWC-SORP Tango cruise in the Scotia Sea near Islas Orcadas del Sur (South Orkney Islands).

5.1.1.2 ANTARCTIC BLUE WHALE CATALOGUE

Brownell presented SC/65b/SH20 on behalf of the authors. This paper reported on comparisons of photographs of fifty-two individual Antarctic blue whales taken between 2005/2006 and 2012/2013 from JARPA II from IWC Management Areas III, IV and V made to a collection of 305 photo-identified Antarctic blue whales in the Antarctic Blue Whale Catalogue. Three whales matched to individuals in the collection with time intervals of 2 years (for 1 whale) and 7 years (for 2 whales). The addition of 49 newly identified Antarctic blue whales from JARPA II brings the total number of photo-identified Antarctic blue whales up to 354. The sighting histories of individual Antarctic blue whales from photo-ID provide data for capture-recapture estimates of abundance as well as information on the movement of individual blue whales within the Antarctic region.

The sub-committee thanked the authors for this ongoing work and **recognised** its contribution to its on-going work. It strongly **recommended** that blue whale research be prioritised in upcoming Japanese Southern Ocean sighting cruises.

5.1.1.3 ACOUSTIC STUDIES

Work within the Antarctic Blue Whale Project (ABWP) of the Southern Ocean Research Partnership has resulted in a number of developments in the use of directional (DIFAR) sonobuoys which give bearing information to baleen whale calls. Bearing information has a number of uses including locating animals for further study, such as photo-id, but also for many applications related to estimates of abundance derived from acoustic data. DIFAR sonobuoys were used successfully during the 2013 Antarctic Blue Whale cruise to locate blue whales from distances of hundreds of kilometres and hence the steering committee of the ABWP has encouraged their use more widely within the project. DIFAR sensors consist of a single omni-directional pressure sensor, two directional particle-velocity sensors, and a magnetic compass. By comparing the amplitude and phase of signals on each of the three acoustic sensors it is possible to calculate the direction that a sound is coming from.

Three papers were presented describing software tools to facilitate the use of DIFAR to obtain bearing information in real time (SC/65b/SH06), results of experiments to measure the accuracy and precision of a sonobuoy-based localisation system (SC/65b/SH08), and methods to estimate the drift of sonobuoys (SC/65b/SH09). Most DIFAR sonobuoys send data via VHF radio link back to an aircraft or nearby vessel. While there are some general purpose tools available for working with DIFAR signals, full analysis has required a limited number of bespoke systems, including a more user-friendly software system.

SC/65b/SH06 described the initial version of such software with the PAMguard framework, an open source, modular package for acoustic data collection and analysis. The modular nature allows the DIFAR module to be incorporated alongside the other features of PAMguard. The DIFAR module has been tested on data from the 2013 cruise and appears to work well. It is expected to be included in PAMguard version 1.13 to be released in 2014. Two dimensional locations can be obtained by crossing bearings from two or more sonobuoys. The accuracy and precision of localisation depend on accurate knowledge of the location of the sonobuoy, the local magnetic declination, the accuracy and precision of the sonobuoy compass, accurate calibration of the VHF receivers and recording chain, and the ratio of signal to noise present at each sensor.

SC/65b/SH08 described methodology to calibrate the sensors and estimate the errors in measured bearings. The sensors are initially calibrated using the ship as a sound source at a known location relative to the buoy deployment. This procedure simultaneously applies a correction for compass error and magnetic variation. Subsequent bearings to the ship were used to estimate bearing error giving unbiased bearings with standard deviations of between 5° and 9°. These results compare well with the manufacturer's specification. Considerations need to be given to a number of factors related to bearing accuracy including proximity to the magnetic pole, occasional 180° errors, and the standard deviation of bearings computed during the calibration process.

Drift in location can become an issue when sonobuoys are monitored for long periods of time and this was examined in SC/65b/SH09. The track of a single whale (where locations derived from sonobuoys could be compared to visual locations where distances and angles were measured photogrammetrically) was analysed to investigate drift. A model for sonobuoy drift was developed from the acoustic and visual bearings (assuming no error in the visual) to obtain maximum likelihood estimates of the direction and speed of drift which were assumed constant during the deployment. The results showed that allowing for drift did improve accuracy at close distances but not much at further distances. The geometry of the two buoys relative to the whale will tend to have a stronger influence on location accuracy than drift. For future study using DIFAR sonobuoys it is worth trying to maximise opportunities to periodically measure bearings to a known source such as the research vessel, in order to estimate sonobuoy drift, especially during long deployments.

Measurements of the source levels of blue whale calls and propagation loss are important for determining the likely distances over which whale calls may be detected. SC/65b/SH11 presented preliminary estimates of source levels for the first (unit A) 25-29Hz component of Antarctic blue whale 'Z' calls. Estimates were made from two sets of data. A fine-scale data set contained 116 acoustic detections from 58 calls where the whale was within 30km of the receiver. The location of the whale was determined from a track derived from visual surfacings where distances and angles were measured photogrammetrically. A broad-scale data set contained 6,738 calls mostly at ranges of several hundred km. These were grouped together into 340 mean received levels that corresponded to a visual sighting location. The basic assumption was that acoustic propagation between a shallow source and shallow receiver can be represented by a zone of spherical spreading at short range followed by cylindrical spreading in a surface duct at greater ranges. Based on these assumptions the results show that call unit A is produced at relatively constant source levels of 180-187 dB re 1 μ Pa rms. Estimates of the transition range at which cylindrical spreading starts were around 1km. These source levels are similar to previous estimates for Antarctic blue whales and add considerably to the number of measurements. The results also show that acoustic propagation from a shallow source to a shallow receiver can be modelled as a simple surface duct with reasonable accuracy. With these source levels, and under these propagation conditions, Z-calls of Antarctic blue whales can be detected from thousands of kilometres away.

Measurements of calls from Antarctic blue whales spanning many years have revealed a long-term linear decline as well as an intra-annual pattern in tonal frequency. A number of hypotheses for this long-term decline have been investigated.

These include changes in population structure, changes in the physical environment, and changes in the behaviour of the whales. However, there have been relatively few attempts to explain the intra-annual pattern. An additional hypothesis investigated in Miller et al. (2014a) is that differences in the observed peak-frequency from each call are due to the Doppler effect. The assumptions and implications of the Doppler effect on whale song were investigated using vessel-based acoustic recordings of Antarctic blue whales with simultaneous observation of whale movement and long-term acoustic recordings from both the subtropics and Antarctic. Results from vessel based recordings of Antarctic blue whales indicate that peak frequency variation between calls produced by an individual whale was greater than would be expected by the movement of the whale alone. Furthermore, analysis of intra-annual frequency shift at Antarctic recording stations indicates that the Doppler effect is unlikely to fully explain the observations of intra-annual pattern in the frequency of Antarctic blue whale song. However, data do show cyclical changes in frequency in conjunction with season, thus suggesting that there might be a relationship among tonal-frequency, body condition, and migration to and from Antarctic feeding grounds.

Taking these methodological papers as a whole, the sub-committee noted that the results had confirmed the potential to detect blue whales at over 1,000-km in the Southern Ocean. The sub-committee recognised the advancements that these methodologies had made to the abundance estimation of Antarctic blue whales, and **encouraged** the continuation of this important research.

Shabangu and Findlay (2014) summarised the IWC IDCR/SOWER acoustic sonobuoy survey data. The South African Blue Whale Project applied for and received the IWC IDCR/SOWER Antarctic and low-latitude blue whale cruise acoustic recordings from sonobuoys. The examination and collation of the data included the compilation of a dataset comprising the sourcing and review of acoustic files and the development of a database of acoustic files and station data while removing of duplicate files. Such cataloguing, file review and naming of the acoustic data resulted in some 7500 acoustic files from over 700 stations across both the IWC SOWER Antarctic cruises from 1996/1997 through to 2008/2009 in Areas I-VI, and the three blue whale cruises off Australia, Madagascar and Chile. A total of 1547.76 hours of recordings have been initially reviewed and blue whale vocalisations (either Z or D calls) have been detected on 4,155 (55%) of the 7,501 recorded files. The incidence of call rates (of both call types) from these acoustic files is currently being investigated particularly in light of the fact that stations may have visual observations of blue whales in association with the recordings.

Van Opzeeland *et al.* (2014) reported on the SOHN initiative of the IWC-SORP Acoustic Trends Project, an international effort to implement a long term acoustic research program that aims to examine trends in Southern Ocean blue whale and fin whale (*B. physalus*) abundance, distribution, and seasonal presence through the use of passive acoustic monitoring techniques. To achieve this goal, the Acoustic Trends Working Group proposes the creation of a Southern Ocean Hydrophone Network (SOHN) comprising a circumpolar network of autonomous acoustic recording stations surrounding the Antarctic continent with at least one recording site in each of the six IWC management areas. High priority will be given towards achieving simultaneous temporal coverage over the ten year duration of the project. This document provides practical recommendations to increase the efficiency of passive acoustic data collection in Antarctic waters, by outlining the requirements of SOHN acoustic recorders, and their potential for integration with oceanographic data collection efforts, as well as the potential for servicing of SOHN acoustic stations from ships of opportunity. Standardisation of data is paramount for accurate and efficient analysis and interpretation of SOHN data, and will facilitate future comparisons with baseline data collected from the SOHN. Furthermore, by introducing such standardised data collection protocols the authors aim to increase participation by partner nations and organisations in both the SOHN and Acoustic Trends Projects.

5.1.1.4 ABUNDANCE ESTIMATION

SC/65b/SH13 introduced analyses on precision of a future Antarctic blue whale line-transect survey. Part of the planning process for the IWC-SORP Antarctic Blue Whale Project has been to test how much effort would be required under various survey methods to return a precise estimate of circumpolar abundance for the species. SC/65b/SH13 is an exploration of the precision of a circumpolar abundance estimate that might be expected from a line-transect survey, and in particular, how the precision of an abundance estimate might be predicted for varying amounts of survey effort, given the situation that the study population is, in fact, increasing. To match with IDCR/SOWER surveys, two survey durations were selected, 6 and 12 years, both to start in 2013; resultant abundance estimates correspond to a mid-point of 2016 and 2019, respectively. Because most sightings of Antarctic blue whales are close to the sea ice boundary in summer (Branch *et al.* 2007), the circumpolar region was stratified into 'northern' and 'southern' strata in this study. With the aim of completing a circumpolar survey in 6 or 12 years, non-overlapping blocks of either 60° or 30° of longitude, respectively, would have to be covered each summer season. The precisions returned for the 6 year programmes, were all too low to be considered useful. Over a 12 year programme, the predicted precision (CV) for a circumpolar abundance estimate, at N_0 (initial abundance) of 2,280 and r (annual rate of increase) of 6.4% (i.e. the agreed IWC Antarctic blue whale estimates), was 0.27, which would be considered a reasonably useful level of precision. Line transect methods are well established and widely understood; can easily allow collection of sighting data for multiple species; the necessary distribution of transects allows for collection of environmental covariates from a broad spatial range, leading the way to extra environmental modelling; and, finally, such a future abundance estimates would be directly comparable with those previously made with IDCR/SOWER data. Conversely, line transect can be labour intensive; requires coverage of low

density regions (although not necessarily at the same rate as higher density areas); and does not ordinarily facilitate the collection of data to study individual movement and population structure.

The sub-committee noted in discussion that pre-survey analyses such as these are important and should be encouraged.

SC/65b/SH14 described exploration of a future mark-recapture study of Antarctic blue whales. To properly conserve and manage wild populations, it is important to have information on abundance and population dynamics. In the case of rare and cryptic species, especially in remote locations, surveys can be difficult and expensive, and run the risk of not producing sample sizes large enough to produce precise estimates. Therefore, it is crucial to conduct preliminary analysis to determine if the study will produce useable estimates. The focus of SC/65b/SH14 is a proposed mark-recapture study of Antarctic blue whales for the IWC-SORP Antarctic Blue Whale Project. The paper describes a model to predict the precision and bias of estimates from a hypothetical survey programme. The analysis showed that mark-recapture is indeed a suitable method to provide a circumpolar abundance estimate of Antarctic blue whales, with precision of the abundance, at the mid-point of the programme, predicted to be between 0.2 and 0.3. However, this was only if passive acoustic tracking was utilised to increase the encounter rate. The analysis also provided guidance on general design for an IWC-SORP Antarctic Blue Whale Project, showing it required duration of 12 years; although surveys did not necessarily need to be run every year if multiple vessels are available to clump effort. Mark-recapture is based on a number of assumptions; it was evident from the analysis that ongoing analysis and monitoring of the data would be required to check such assumptions hold (e.g., test for heterogeneity), and the modelling adjusted as needed.

The sub-committee noted that a procedural change in sampling could potentially reduce the observed male bias in biopsy sampling, and it discussed whether this would be beneficial. It was concluded that while this could be valuable in minimising biases, concentrating on males could result in a higher number of recaptures, and consequently increase the precision of mark-recapture estimates.

In discussion, it was noted that although the procedure provided estimates of population trends and natural mortality rates, their precision was too poor for them to be meaningful. Nevertheless, this did not invalidate the abundance estimates themselves.

Finally, the sub-committee noted that there had been recent work which allowed an integrated use of photo-identification and biopsy data in a two-source mark-recapture model. If it were possible to reconcile photo-identification with biopsy data (i.e., DNA profiles) for individual blue whales then such an analytical approach could be considered in future analyses.

SC/65b/SH17 noted that the biopsies from the proposed IWC-SORP mark-recapture study for Antarctic blue whales could also be used to identify parent-offspring pairs. These 'recaptures' can be accommodated in an extended mark-recapture model, which would dramatically improve the precision of abundance estimates from the study (from 27% in the base-case scenario of SC/65b/SH15, down to 17% with this approach, and without requiring any additional survey effort). Also, with parent-offspring pairs, the model could be made robust against bias arising from un-modelled heterogeneity, without inflating the CV. Precision could be improved further using epigenetic age data to tell which animal is the parent and which the offspring.

The sub-committee discussed the relative priority of biopsy and photo-identification sampling given cost of Antarctic operations. SC/65b/SH17 highlighted the value of biopsy sample collection whenever possible given the range of analyses that can be carried out. However, others highlighted the relative ease of photo-identification of blue whales, particularly when poor weather compromised biopsy sampling, and reported that both types of samples were possible with the right vessel approach.

The sub-committee noted that some 50-80 samples would be required per year for this technique which was plausible and that the technique therefore appeared to be very convincing.

Peel *et al.* (2014) focused on acoustics as a tool incorporated within mark-recapture surveys to increase the encounter rate beyond using visual searching only. While this general approach is not new, its utility is rarely quantified. This study predicted the 'acoustically-assisted' encounter rate using a discrete-time individual-based simulation of whales and survey vessel. The simulation framework was tested using existing data from studies of sperm whales. The framework was then used to predict potential encounter rates in a study of Antarctic blue whales. Also investigated were the effects of a number of the key parameters on encounter rate. Mean encounter rates from the simulation of sperm whales matched well with empirical data, although the variance of encounter rate was underestimated. The simulation of Antarctic blue whales found that passive acoustics should provide a 1.7–3.0 fold increase in encounter rate over visual-only methods. Encounter rate was most sensitive to acoustic detection range, followed by vocalisation rate. During survey planning and design, some indication of the relationship between expected sample size and effort is paramount; this simulation framework can be used to predict encounter rates and establish this relationship. For a case in point, the simulation framework indicates unequivocally that real-time acoustic tracking should be considered for quantifying the abundance of Antarctic blue whales via mark-recapture methods.

In response to a question of the deployment of sonobuoys that are not recovered, it was noted that the use of recoverable sonobuoys are being investigated.

Bannister presented Olsen and Kinzey (In press) on behalf of the authors. This paper described the results of a capture-recapture analysis of Antarctic blue whale photographs taken on 15 IDCR/SOWER cruises from 1991/92 to 2008/09. Abundance estimates were obtained for both the entire circumpolar region and for IWC Management Area III. Separate estimates were made for left and right side photographs. Currently there are 219 individuals in the Antarctic blue whale catalogue, which is around 10% of the circumpolar abundance in 1998, as estimated by Branch et al. (2007). Using the package 'RMark', a POPAN model was used to estimate circumpolar and Area III abundance for both left and right photographs, giving circumpolar abundance for 1992-2009 from the left side of 3,151 (95% CI=530-24,113) and 4,286 (95% CI=1,923-9,802) for the right side, both with rather large confidence intervals. The estimates are based on five recaptures. For Area III, the corresponding estimates were 1,318 (95%CI=514-3,716 left side) and 939 (95%CI=421-2,323 right side).

The sub-committee welcomed the analysis and its results and noted that it was the first available estimates since Branch et al. (2007). The authors were not present at the meeting and so the sub-committee **recommended** that they be invited in the future to discuss this work.

5.1.2 Pygmy type blues

SC/65b/SH02 reported on increasing indications that blue whales use the South Taranaki Bight (STB) in New Zealand as a foraging ground for krill over the last 10 years. Between 21 January and 4 February 2014 an experienced field team undertook field surveys in this area to: collect photo-identification data; obtain tissue biopsy samples; record environmental and prey data and; document foraging behaviour. Over five days of survey work, 314km of survey effort were conducted in the STB. Ten sightings of blue whales were made of an estimated 50 individual blue whales, including a cow/calf pair. A minimum of 21 blue whales were identified through photo-ID analyses, with only one possible re-sight of an individual, indicating that a relatively low proportion of the blue whales present in the STB were encountered during the field work. Ten biopsy and two faecal samples were collected. Behaviour patterns consistent with blue whale foraging in other regions were frequently observed. Krill swarms were observed at five sightings and detected hydro-acoustically in dense surface patches and in a widespread, near-bottom layer. Observations and data collected during this field effort strongly support the hypothesis that the STB is a blue whale foraging ground. Continued data collection and analyses are needed to determine the significance and extent of this foraging ground. Improved information on the ecology (seasonality, spatial extent, behaviour, genetics) and abundance of this population of blue whales is needed to inform and better manage potential affects from multiple anthropogenic activities in the STB area.

The sub-committee thanked the authors for this submission and **recommended** the continuation of this study. In response to a question on the likely taxonomy of these individuals, it was reported that results of genetic analyses are imminent, and that general morphology, seasonality and location as well as vocalisations had identified that these were not Antarctic blue whales. Work was **recommended** to clarify the population identity of blue whales observed off New Zealand. The sub-committee also noted and reiterated its discussion on pygmy blue whale variation across the Southern Hemisphere at SC/65a (IWC 2014, Annex H, page 259).

It was clarified in discussion that any images of New Zealand blue whales that are submitted to the Southern Hemisphere Blue Whale Catalogue would be matched to all other holdings. Further details on the catalogue and its regional coordination are provided in Item 5.2.1.

Double *et al.* (2014) reported on migratory movements of pygmy blue whales between Australia and Indonesia as revealed by satellite telemetry. Eleven individuals were tagged off western Australia over two years and tracked from between 8 and 308 days covering an average distance of $3,009 \pm 892$ km (mean \pm se; range: 832 km – 14,101 km) at a rate of 21.94 ± 0.74 km per day (0.09 km-455.80 km/day). Whales were generally tagged during March and April and migrated northwards near to the Australian coastline post tag deployment. Whales reached the northern terminus of their migration and potential breeding grounds in Indonesian waters by June. One satellite tag relayed intermittent information to describe aspects of the southern migration from Indonesia with the animal departing around September to arrive in the subtropical frontal zone, south of Western Australia in December. Throughout their migratory range, these whales are exposed to impacts associated with industry, fishing and vessel traffic. These movements therefore provide a valuable tool to industry when assessing potential interactions with pygmy blue whales and should be considered by, particularly as this species continues to recover from past exploitation.

In response to a question on the summer southern distribution of satellite tag positions, the authors stated that these were positions from later in the migration cycle. The sub-committee noted these results with interest and **recommended** the continuation of this work.

The study described in Miller *et al.* (2014b) had previously been received by the sub-committee (IWC 2014, Annex H, Item 5.1.2, SC/65a/SH19) and was not discussed further.

5.1.3 Chilean blues

Galletti Vernazzani updated the sub-committee on efforts to obtain abundance estimates from Chilean blue whales by mark-recapture techniques using photo-ID data collected during marine surveys from 2004 to 2012 in waters off Isla de Chiloé, southern Chile and data collected in 2012 off Isla de Chañaral, northern Chile. To test for photo quality selection, photo-IDs were scored based on (i) three specific variables (contrast, angle and focus) and (ii) one general variable (overall

quality). Datasets for capture-recapture analyses were obtained and were selected to balance bias due to photographic quality and precision due to decreased sample size. To perform abundance estimates analyses, the photo quality selection based on specific variables was used. Both closed and open population models were explored. Under POPAN models, model averaged estimates of super-population abundance were congruent and model averaged estimate of apparent survival was nearly identical for left and right side photographs. Goodness of fit tests revealed a significant transience signal in the left side dataset. No significant violations of mark recapture assumptions were found for the right side datasets. Once complete, these mark-recapture estimates will be the first abundance estimates for this population. The effect of different photograph quality approaches and the impact of a possible transience signal in this population are being investigated.

In response to a comment on the multiple quality controls applied to these data, Galletti Vernazzani noted that subjectivity of quality controls may influence results considerably and that multiple quality controls were consequently valuable in this and likely other photo-identification studies.

The sub-committee welcomed this work and looked forward to the presentation of the final results at SC/66a.

5.2 Southern Hemisphere population structure

5.2.1 Southern Hemisphere Blue Whale Catalogue

The Southern Hemisphere Blue Whale Catalogue is an international collaborative effort to facilitate cross-regional comparison of blue whale photo-identification catalogues. The catalogue currently holds photo-identification catalogues of researchers from major areas off Antarctica, Australia, New Zealand, Eastern South Pacific and the Eastern Tropical Pacific (ETP). The catalogue is organised into three major regions, with a regional coordinator appointed for each. Areas and coordinators are: (1) Australia/New Zealand/Indonesia (Chandra Salgado Kent); (2) Southern Ocean (Paula Olson); and (3) Gulf of California/Eastern South Pacific/ETP (Barbara Galletti Vernazzani). Photo collections from individuals or groups are added to the catalogue by region. When comparisons take place within a region, the regional coordinator appoints a photo-ID expert to perform the matching. Whenever comparisons between regions take place, regional coordinators of those regions appoint one or more experts to perform the matching process. Funding is distributed between regions according to the amount of work that has to be done.

In 2013, the Scientific Committee had recommended that all relevant data holders submit their photos to the catalogue and it was decided to focus the work in finalise the uploading of catalogues and improvements to the software, therefore no additional comparisons were planned for this period. To date, most of the catalogues have been fully uploaded. Only a few have yet to initiate uploading photo-ID or are still in the process of uploading. A total of 1,101 blue whales are catalogued, that accounts for 843 photo-identified from the right, 857 from left side and 23 from flukes. It was noted that at least one of the contributed catalogues included duplicated whales and therefore it is suggested to perform matching process within group's catalogue before continuing with regional comparisons. In future work, it was proposed that comparisons within Indonesia/Australian/New Zealand region be started, that catalogues from South America and Antarctica be updated with new photo-ID obtained from the recent field season and that the matching process start with these newly incorporated whales. In order to avoid delays, it is also proposed that photographic catalogues are submitted to the regional coordinator and that one person is appointed to be in charge of the uploading process.

The sub-committee noted the value of the SHBWC and **recommended** its continuation. This is an item with financial implications (see Item 7.2).

Noting that the catalogue had grown in the last few years, the sub-committee discussed the effectiveness of multiple quality control and matching process by both the contributing institutions and the SHBWC. It was noted that the issue is complex, uniform control is required and that the SHBWC may need to take this responsibility. A workshop of contributing partners was suggested, although it was noted that the majority of the catalogue is currently contributed by a few organisations and that these could refine contribution procedures via correspondence. The sub-committee **recommended** an intersessional email correspondence group to achieve this goal.

In response to a question on active targeting of opportunistic photo-identification data (e.g. the Antarctic tour industry) it was noted that this had not yet been done by the SHBWC, but that IWC-SORP had made such approaches through the International Association of Antarctica Tour Operators (IAATO, CCAMLR and National Antarctic Programs).

5.2.2 Genetic analyses

Torres-Florez *et al.* (2014) reported on genetic relationships between the whales from southeastern Pacific (SEP) areas of southern Chile, northern Chile and Eastern Tropical Pacific (ETP) and Antarctic blue whale feeding grounds using seven microsatellite loci and mtDNA control region sequences. Significant differences between Antarctica and the other three areas of the SEP were found, but not between the two areas in Chile, nor between the ETP. While data and current analyses support the hypothesis that blue whales sampled in the SEP belong to a unique population, additional and more systematic sampling efforts are needed across this expansive range, particularly in the South Pacific Gyre, the ETP and the west coast of the Antarctic Peninsula. Analyses now underway will build upon this dataset by including eastern North Pacific blue whale samples with the aim of a better understanding blue whale population structure in the North and South Pacific Oceans.

The sub-committee discussed that, as with many areas, the intermixing of blue whales from the North Pacific, Southeastern Pacific and Antarctica provides challenges that may affect the degree of population structure that can be detected in samples from the ETP. The stock structure implications of this paper were also discussed by the Working Group on Stock Definition and can be found in Annex I.

6. REVIEW NEW INFORMATION ON SPERM WHALES

In SC/65a, an intersessional e-mail group was established to consider the feasibility of a future assessment of sperm whales (IWC 2014, Annex H, p 263). Due to a high priority on the completion of the assessment of humpback whale breeding stocks BSD/BSE1/BSO, there was inadequate time to consider this agenda item in SC/65b. However, it was reflected that a study of sperm whale genetic diversity (Alexander *et al.* 2012) was discussed by the Working Group on Stock Definition (see Annex I, Item 2.1). In addition, an epigenetic aging method for skin samples described for humpback whales (see Item 3.2.1) has also been calibrated for sperm whales (Powlanski *et al.* 2014).

7. WORK PLAN AND BUDGET CONSIDERATIONS

7.1 Humpback whales

7.1.1. Southern Hemisphere humpback whales

With the completion of the assessment of humpback whale breeding stocks BSD/BSE1/BSO, the sub-committee **agreed** that the Southern Hemisphere humpback whale assessment has been concluded. However, given that this circumpolar assessment had taken eight years to complete, the sub-committee **recommended** a thorough review and synthesis of assessment results and unresolved questions. It was **agreed** that this would be best achieved through an intersessional e-mail group led by Jackson, with members and terms of references identified in Table 3. The product of this work would be a summary document to be presented and discussed in SC/66a.

It was further **recommended** that SC/66b focus on the planning of the future direction of the sub-committee. Topics would include the feasibility of conducting assessments of other Southern Hemisphere species and consideration of further assessments of humpback whales. With regard to the latter, a literature review would be undertaken to identify all new information produced on Southern Hemisphere humpback whales since the Comprehensive Assessment began in 2006. This work would be undertaken by Jackson with a budget request of 1,000 GBP (SC/65b/SHRP01), for delivery at SC/66b.

The sub-committee recognised the long-term value of photo-identification catalogues to support future assessments and **recommended** that work continue on the Antarctic Humpback Whale Catalogue. This would be undertaken by Carlson and colleagues with a budget request of 15,000 GBP annually in 2015 and 2016. Details can be found in SC/65b/SHRP03.

Consideration was also given to the importance of evaluating on-going and future data collection to better inform future assessments. A modelling effort was **recommended** as one means of informing this question. This work would be undertaken by Butterworth and colleagues with a budget request of 2,000 GBP in each year (see Item 3C in SC/65b/SHRP02).

As noted previously, the sub-committee **recommended** two intersessional e-mail groups to address questions arising specifically from the assessment of BSD/BSE1/BSO. These included work to evaluate (1) the available genetic data, assumptions and analytical approaches for establishing mixing proportions of breeding stocks in the Antarctic and (2) the minimum abundance of BSD, which is only currently available as a preliminary value, but important to the interpretation of assessment results. Terms of reference of these groups and their membership are provided in Table 3.

7.1.2. Arabian Sea humpback whales

The sub-committee **recommended** a combination of exploratory surveys and molecular genetics for the Arabian Sea population, to be undertaken by Willson, Rosenbaum and colleagues, with a budget request of 14,600 GBP in 2015 and 17,300 GBP in 2016. Exploratory surveys would be undertaken in both years off Gujarat, India to determine seasonal patterns in spatial and temporal habitat use of humpback whales. Soviet whaling data suggest that this is a historical hotspot and current information would be gathered through interviews of marine users and opportunistic vessel based surveys. Recommendations to continue exploratory surveys in 2016 would be refined after initial results are received by the sub-committee in SC/66a. Molecular genetic sexing of biopsy samples (collected since 2005) was **recommended** to guide satellite tagging efforts. Additional genetic analyses were recommended in the second year to allow genotypic matching and population-level comparisons. Further details are provided in SC/65b/SHRP06.

The sub-committee made several additional **recommendations** that had no budgetary implications, as follows: (1) the continuation of satellite tagging of humpback whales off Oman; (2) an intersessional workshop in 2014 to facilitate research capacity building, prioritisation of research in potential hotspots and further assessment of escalating threats, and (3) continuation of an Arabian Sea intersessional e-mail correspondence group, with membership and terms of reference given in Table 3. Further details on these items are given in Item 4.

7.2 Blue whales

The sub-committee **recommended** that work continue on the Southern Hemisphere Blue Whale Catalogue. Work would be conducted by Galletti and associated researchers with a total budget request of 15,000 GBP for 2015 and 18,300 GBP for 2016. Details of the proposed work are provided in SC/65b/SHRP04.

An intersessional e-mail group was also **recommended** to further develop and reinforce SHBWC protocols, as described in Table 3, and to ensure clear communication of the terms of reference of the catalogue to current, pending and future contributors.

The sub-committee recognised that considerable new information has become available for pygmy blue whales in recent years, especially with regard to genetics, acoustics and movements. An intersessional working group was **recommended** to bring relevant information to SC/66a so that regions with adequate data can be identified for a potential future assessment. The membership and terms of reference of this group are shown in Table 3 and would be expanded to include data holders from a range of areas, including: Chile-Peru, New Zealand, Australia, Kerguelen/Crozet-Central Southern Indian Ocean, NIO-Sri Lanka, Madagascar Plateau, South Africa and the South Atlantic.

7.3 Sperm whales

The sub-committee **recommended** the continuation of an intersessional e-mail group to consider the feasibility of a future assessment of sperm whales. Group membership and terms of reference are listed in Table 3.

7.4 Southern Ocean Research Partnership (IWC-SORP)

The sub-committee **recommended** the continuation of the five on-going IWC-SORP research projects. It also **recommended** the continuation of a funded coordinator position within IWC-SORP to achieve the following: (1) leverage future funding ; (2) ensure the communication of high-calibre scientific research to Scientific Committee, the IWC and the wider scientific community; and thus (3) sustain the momentum of the collaborative research effort. This position involves a budget request of 17,596 GBP in Year 1 and 17,734 GBP in Year 2, and further details are provided in SC/65b/SHRP07.

The sub-committee noted that the budgetary implications of the coordinator position were substantial, and that the products of IWC-SORP are relevant to several other sub-committees. It therefore suggested that the budget be considered more broadly across the Scientific Committee. It also **recommended** that the Commission be urged to consider this budget request.

8. Adoption of the report

The report was adopted on 09:59 on 21 May 2014. The chair and the rapporteur were thanked for their efforts.

Table 3: Intersessional e-mail groups.

Group	Terms of reference	Membership
Review and synthesis of the Comprehensive Assessment of Southern Hemisphere humpback whales	To prepare a document synthesising the results of the Comprehensive Assessment for presentation at SC/66a.	Jackson (convenor), Baker, Butterworth, Findlay, Robbins, Rosenbaum, Ross-Gillespie, Weinrich, Zerbini
Applying mixed stock analyses in future population assessments of humpback whales	To discuss and resolve the current sampling and analytical limitations of the mixed stock analysis approach, including: 1) sample sizes collected from breeding grounds and their influence on mixing proportions (<i>i.e.</i> allowance in the estimation for imprecision in the estimates of genetic frequency distributions for breeding stocks), 2) population substructure in Oceania and the impact of combining versus using individual stocks on catch allocation, 3) some possible stratifications of the 'pure' breeding stock samples to test alternate composition of 'pure' stocks (particularly with respect to East Australia), 4) developments of the likelihood model to account for unsampled haplotypes.	Jackson (convenor), Baker, Butterworth, Double, Kitakado, Pastene, Ross-Gillespie, Waples, Weinrich
Further evaluate the minimum abundance of Breeding Stock D	To further evaluate the preliminary minimum estimate of BSD used in the assessment of humpback whale breeding stocks D/E/F	Robbins (Convenor), Bannister, Butterworth Jackson, Kelly and others.
Protocols and procedures of the Southern Hemisphere blue whale catalogue	Further develop and reinforce SHBWC protocols and ensure clear communication of the terms of reference of the catalogue to current, pending and future contributors.	Galletti (Convenor), Matsuoka, Olson, Salgado and others.
Arabian Sea working group	Continuation of the previously established intersessional Arabian Sea working group.	Baldwin (Convenor), Brownell, Carlson, Collins, Findlay, Gales, Leslie, Rosenbaum, Willson, Zerbini.
Investigate the feasibility of a future sperm whale assessment	Continue to identify data availability and needs to undertake a future assessment of sperm whales. Information would be sought in the	Brownell (Convenor), Baker, Bannister, Bell, De La Mare, Hoelzel, Kasuya, Kato, Leaper,

	following categories: (1) population structure within ocean basins; (2) population size within ocean basins and abundance in smaller areas; (3) catch history; and (4) consideration of the development of a new assessment model.	Mate, Matsuoka, Mesnick, Miyashita, Murase, Palacios, Perrin, Reeves, Smith, Whitehead.
Pre-assessment of pygmy blue whales	(1) identify/geographic groups for which assessments/status could be undertaken, (2) identify those for which assessment/status reviews can be initiated and completed for the 2016 meeting, and (3) identify tasks needed and who would complete them for the 2016 meeting.	Bannister (Convenor), Galletti and regional data holders

REFERENCES

- Alexander, A., Steel, D., Silkas, B., Hoekzema, K., Carraher, C., Parks, M., Cronn, R. and Baker, C.S. 2012. Low diversity in the mitogenome of sperm whales revealed by next-generation sequencing. *Genome Biology and Evolution* 5(1): 113-119. DOI: 10.1093/gbe/evs126.
- Bannister, J.L. and Hedley, S.L. 2001. Southern Hemisphere Group IV humpback whales: their status from recent aerial surveys. *Mem. Qld Mus.* 47(2):587-590.
- Branch, T.A., 2011. Humpback whale abundance south of 60°S from three completed sets of IDCR/SOWER circumpolar surveys. *J. Cetacean Res. Manage. Special issue* 3, 53-69.
- Constantine R, Jackson J.A., and Steel D., *et al.* 2012. Abundance of humpback whales in Oceania using photo-identification and microsatellite genotyping. *Marine Ecology Progress Series* 453, 249-261.
- Corkeron PJ, Minton G, Collins T, Findlay K, Willson A, Baldwin R (2011) Spatial models of sparse data to inform cetacean conservation planning: an example from Oman. *Endang. Species Res.* 15:39-52
- Double, M.C., Andrews-Goff, V., Jenner, K.C.S., Jenner, M.N., Laverick, S.M., Branch, T.A. and Gales, N.J. 2014. Migratory movements of pygmy blue whales (*Balaenoptera musculus breviceauda*) between Australia and Indonesia as revealed by satellite telemetry. *Journal?* 30pp.
- Forestell, P.H., Kaufman, G.D. and Chaloupka, M. 2011. Long term trends in abundance of humpback whales in Hervey Bay, Australia. *J. Cetacean Res. Manage. (Special Issue)* 3, 237-241.
- Fossette, S., Heide-Jørgensen, M.P., Jensen, M.V., Kiszka, J., Bérubé, M., Bertrand, N. and Vély, M. 2014. Humpback whale (*Megaptera novaeangliae*) post breeding dispersal and southward migration in the western Indian Ocean. *Journal of Experimental Marine Biology and Ecology* 450: 6-14
- Hedley, S.L., Dunlop, R.A. and Bannister, J.L. 2011. Evaluation of WA Humpback surveys 1999, 2005, 2008: Where to from here? In: Report to the Australian Marine Mammal Centre on work done to 6th May, 2011, p. 28.
- International Whaling Commission 2007. Report of the Scientific Committee, Annex H: Report of the sub-committee on other Southern Hemisphere whale stocks. *J. Cetacean Res. Manage. (Suppl.)* 9.
- International Whaling Commission 2010. Report of the Scientific Committee, Annex H: Report of the sub-committee on other Southern Hemisphere whale stocks. *J. Cetacean Res. Manage. (Suppl.)* 11(2).
- International Whaling Commission 2011. Report of the Scientific Committee, Annex H: Report of the sub-committee on other Southern Hemisphere whale stocks. *J. Cetacean Res. Manage. (Suppl.)* 12.
- International Whaling Commission 2012. Report of the Scientific Committee, Annex H: Report of the sub-committee on other Southern Hemisphere whale stocks. *J. Cetacean Res. Manage. (Suppl.)* 13.
- International Whaling Commission 2013. Report of the Scientific Committee, Annex H: Report of the sub-committee on other Southern Hemisphere whale stocks. *J. Cetacean Res. Manage. (Suppl.)* 14.
- International Whaling Commission 2014. Report of the Scientific Committee, Annex H: Report of the sub-committee on other Southern Hemisphere whale stocks. *J. Cetacean Res. Manage. (Suppl.)* 15.
- Jackson, J.A., Anderson, M., Steel, D.S., Brooks, L., Braverstock, P., Burns, D., Clapham, P., Constantine, R., Franklin, W., Franklin, T., Garrigue, C., Hauser, N., Paton, D., Poole, M., Baker, C.S. 2012. Multistate measurements of genotype interchange between East Australia and Oceania (IWC breeding sub-stocks E1, E2, E3 and F2) between 1999 and 2004. Paper SC/64/SH22 presented to the IWC Scientific Committee, June 2012 (unpublished). 16pp
- Miller, B.S., Leaper, R., Calderan, S. and Gedamke, J. 2014a. Red shift, blue shift: Doppler shifts and seasonal variation in the tonality of Antarctic blue whale song
- Miller, B.S., Collins, K., Barlow, J., Calderan, S., Leaper, R., McDonald, M., Ensor, P., Olson, P., Olavarria, C. and Double, M.C. 2014b. Blue whale vocalisations recorded around New Zealand: 1964-2013. *Journal?*: 16pp.
- Olavarria, C., Baker, C.S., Garrigue, C. 2007. Population Structure of South Pacific humpback whales and the origin of the eastern Polynesian breeding grounds. *Marine Ecology Progress Series* 330, 257-268.
- Olsen, P.A. and Kinzey, D. In press. Using Antarctic blue whale photo-ID data from IDCR/SOWER: capture-recapture estimates of abundance. *JCRM Special Issue* 4:7pp
- Orgeret, F., Garrigue, C., Gimenez, O. and Pradel, R. In review. Robust assessment of population trends in marine mammals applied to the New Caledonia humpback whales. *Marine Ecology Progress Series*: 9pp.
- Pastene, L.A., Kitakado, T., Goto, M. and Kanda, N. 2013. Mixing rates of humpback whales of Stocks D, E, and F in the Antarctic feeding grounds based on mitochondrial DNA analysis. Paper SC/65a/SH13 presented to the IWC Scientific Committee, June 2013 (unpublished). 11pp.
- Peel D, Miller BS, Kelly N, Dawson S, Slooten E, and Double, M.C. (2014). A simulation study of acoustic-assisted tracking of whales for mark-recapture surveys. *PLoS ONE* 9(5): e95602. doi:10.1371/journal.pone.0095602
- Polanowski, A.M., Robbins, J., Chandler, D. and Jarman, S.N. 2014. Epigenetic estimation of age in humpback whales. *Mol. Ecol. Res.* 2014: 12pp
- Rasmussen, K, Calambokidis, J. and Steiger, G.H. 2012. Distribution and migratory destinations of humpback whales off the Pacific coast of Central America during the boreal winters of 1996-2003. *Mar. Mamm. Sci.* 28(3):E267–E279. doi: 10.1111/j.1748-7692.2011.00529.x
- Rasmussen, K. and D.M. Palacios. 2013. Highlights from a Decade of Humpback Whale Research in the Gulf of Chiriqui, Western Panama, 2002-2012. Paper SC/65a/SH04 presented to the IWC Scientific Committee, June 2013, Jeju, Korea, 8pp (unpublished).
- Rasmussen, K., Palacios, D.M., Calambokidis, J., Saborio, M.T., Dalla Rosa, L., Secchi, E.R., Steiger, G.H., Allen, J.M. and Stone, G.S. 2007. Southern hemisphere humpback whales wintering off Central America: Insights from water temperature into the longest mammalian migration. *Biol. Lett.* 3 (3):302. doi:10.1098/rsbl.2007.0067.
- Raymond, B., 2012, updated 2013. Polar Environmental Data Layers Australian Antarctic Data Centre - CAASM Metadata. Rosenbaum, H., Maxwell, S.M., Kershaw, F. and Mate, B. 2014. Long-range movement of humpback whales and their overlap with anthropogenic activity in the South Atlantic Ocean). *Conservation Biology*:12pp.
- Shabangu, F.W. and Findlay, K. 2014. Overview of the IWC IDCR/SOWER cruise acoustic survey data. *Journal?*5pp

- Torres-Florez, J.P., Hucke-Gaete, R., LeDuc, R., Lang, A., Taylor, B., Pimper, L.E., Bedriñana-Romano, L. and Rosenbaum, H.C. 2014. Blue whale population structure along the eastern South Pacific Ocean: evidence of more than one population. *Journal??* 37pp
- Van Opzeeland, I.C., Samaran, F., Stafford, K.M., Findlay, K., Gedamke, J. and Miller, B.S. 2014. The Southern Ocean Hydrophone Network (SOHN). Circum-Antarctic passive acoustic monitoring of Antarctic blue and fin whales. *Journal??* : 25pp

Appendix 1

AGENDA

1. Introductory items
 - 1.1. Opening remarks
 - 1.2. Election of Chair
 - 1.3. Appointment of rapporteurs
 - 1.4. Adoption of the agenda
 - 1.5. Review of documents (SC/65b/SH01-20, IA10, ForInfo03, 06-08, 10, 14-15, 18, 26, 30, 31, 34, 39)
2. Southern Ocean Research Partnership
3. Assessment of Southern Hemisphere humpback whales
 - 3.1. Assessment of Southern Hemisphere Breeding Stocks D/E/F
 - 3.1.1. Results of models developed intersessionally
 - 3.1.2. Specification and evaluation of additional model runs
 - 3.1.3. Final assessment model results
 - 3.1.4. Conclusions and recommendations
 - 3.2. Review new information
 - 3.2.1. Breeding stocks D/E/F
 - 3.2.2. Breeding stock G
 - 3.2.3. Breeding stock C
 - 3.2.4. Breeding stock B
 - 3.2.5. Feeding grounds
 - 3.3. Antarctic Humpback Whale Catalogue
 - 3.4. Status of the assessment of Southern Hemisphere humpback whales
4. Arabian Sea humpback population
 - 4.1. Review new information
 - 4.2. Progress toward the development of a Conservation Management Plan and other conservation initiatives
5. Assessment of Southern Hemisphere Blue Whales
 - 5.1. Review new information
 - 5.1.1. Antarctic blues
 - 5.1.1.1. Cruise reports
 - 5.1.1.2. Antarctic Blue Whale Catalogue
 - 5.1.1.3. Acoustic studies
 - 5.1.1.4. Abundance estimation
 - 5.1.2. Pygmy-type blues
 - 5.1.3. Chilean blues
 - 5.1.4. Southern Hemisphere population structure
 - 5.1.4.1. Southern Hemisphere Blue Whale Catalogue
 - 5.1.4.2. Genetic analyses
6. Review new information on sperm whales
7. Work Plan and Budget Considerations
 - 7.1. Humpback Whales
 - 7.2. Blue Whales
 - 7.3. Sperm Whales
 - 7.4. SORP
8. Adoption of the Report

Appendix 2

MIXING PROPORTION OF HUMPBACK WHALE BREEDING STOCKS IN THE ANTARCTIC FEEDING GROUNDS

Luis A. Pastene and Toshihide Kitakado

This paper presents results of the estimations of mixing proportion for two different definitions of boundaries in the feeding grounds of Areas III-E-VI. Baseline samples for Stocks BSD ($n=185$) and BSE1 ($n=104$) are from the study of Schmitt *et al.* (2013) while that of Oceania (NC+TG+CI+FP, $n= 601$) is from the study of Olavarria *et al.* (2007). The

samples in the feeding grounds were obtained during JARPA/JARPAII as well IDCR/SOWER surveys approximately in the period 1990's-2010/11 (Pastene *et al.*, 2013). Results for the boundaries used in 2013 are shown in Table 1 (a) and those for the new boundaries used this year are shown in Table 1 (b). Table 2 shows the number of mtDNA sequences available by 10 degree longitude in the same sector (III-E-VI).

Table 1. Estimated mixing proportions for two different definitions of boundaries in the feeding areas. Round and square brackets are standard errors and 95% CIs, respectively.

(a) 2013 definition					
Feeding Area	Sample size	BSD	BSE1	Oceania	
70E-140E	247	0.8548 (0.0349) [0.772, 0.911]	0.1452 (0.0349) [0.228, 0.089]	0	
140E-160E	56	0.0828 (0.0460) [0.027, 0.228]	0.9172 (0.0460) [0.772, 0.973]	0	
160E-150W	146	0	0.3235 (0.0742) [0.197, 0.482]	0.6765 (0.0742) [0.518, 0.803]	
150W -110W	20	0	0.0000 (0.0000) [0.000, 0.000]	1.0000 (0.0000) [1.000, 1.000]	
(b) 2014 definition					
Feeding Area	Sample size	BSD	BSE1	Oceania	
70E-110E	188	0.9213 (0.0332) [0.827, 0.966]	0.0787(0.0332) [0.034 0.173]	0	
110E-130E	43	0.8974 (0.0855) [0.586, 0.982]	0.1026 (0.0855) [0.018, 0.414]	0	
130E-170E	120	0	0.6802 (0.0666) [0.539, 0.795]	0.3198(0.0666) [0.205, 0.461]	
170E -110W	118	0	0.1080 (0.0654) [0.031, 0.314]	0.8920(0.0654) [0.686, 0.969]	

Table 2. Number of samples (mtDNA sequences) available by 10 degree longitude sectors.

Sector	Sample size
35°-40°E	17
40°-50°E	40
50°-60°E	27
60°-70°E	22
70°-80°E	32
80°-90°E	63
90°-100°E	50
100°-110°E	43
110°-120°E	27
120°-130°E	16
130°-140°E	16
140°-150°E	36
150°-160°E	20
160°-170°E	48
170°E-180°	28
180°-170°W	23
170°-160°W	44
160°-150°W	3
150°-140°W	2
140°-130°W	9
130°-120°W	9

Appendix 3

FINAL RESULTS FOR THE FINAL 'BASE CASE' THREE-STOCK BSD, BSE1 AND BSO MODEL, WITH SENSITIVITY RUNS

A. Ross-Gillespie, D.S. Butterworth and K. Findlay

INTRODUCTION

Paper SC/65a/SH04rev and SC/65a/SH04app presented to the meeting included a three-stock model with mixing of breeding stocks in the feeding grounds, which is referred to below as the 'original model'. The Sub Committee decided to focus on this three-stock approach and also considered an 'alternative' model with a simpler mixing foundation. The Sub Committee agreed to use the alternative three-stock model presented in Fig. 1 (with one interchange parameter) as the base case (hereafter referred to as the base case model) as there were several major concerns regarding the original, six interchange parameter, three-stock model in Fig. 2, including:

- (1) Constraints had to be placed on the six interchange parameters to prevent 'majority cross-overs' (i.e. a scenario where the majority of one stock crosses over into a neighbouring feeding area while the neighbouring stock does the same). These constraints resulted in non-uniform priors that can under-sample high values for interchange rates, which led to inefficient computations when the value for an interchange parameter was likely to be high.
- (2) Many of the interchange parameters, as well as the BSO growth rate parameter, seemed to be poorly estimated.
- (3) The relatively high number of parameters to be estimated in this model led to severe sampling inefficiency.

The alternative (now base case) three-stock model was on the other hand much simpler, with only one interchange parameter that needed to be estimated (namely the proportion of BSE1 whales that feed in the western feeding area). Sampling efficiency remained a problem since parameters had to be estimated for each of the three breeding stocks, although to a far lesser extent than for the original model. Although importance functions had been implemented to address the issue of sampling efficiency, these did not improve the efficiency of the original model greatly.

However it should be noted that the original three-stock model did better capture biological reality, and as such should be revisited in future when further genetic information on mixing proportions in Antarctic feeding grounds is available to inform the estimation of the interchange parameters better.

MODEL RUNS

In the process of multiple model runs, both intersessionally and at this meeting, the sub-committee identified the following assumptions for the final base case model.

- (1) A BSO N_{min} constraint $> 3*33$.
- (2) New Zealand catches (i.e. catches from Rakiura, Kaikoura, Cook Strait, Great Barrier Island and Whangamumu land-stations and three catches specified to New Zealand) are allocated to BSE1 and BSO in proportion to the relative population sizes of these breeding stocks.
- (3) The model is fit to the Hedley *et al.* (2011) and Bannister and Hedley (2001) relative abundance series for BSD; the Noad *et al.* (2011) relative and absolute abundances estimates for BSE1; and the Constantine *et al.* (2012) mark-recapture data for Oceania.
- (4) An uninformative uniform prior of $U[\ln 15000, \ln 40000]$ is used for the log of the target abundance estimate for BSD.

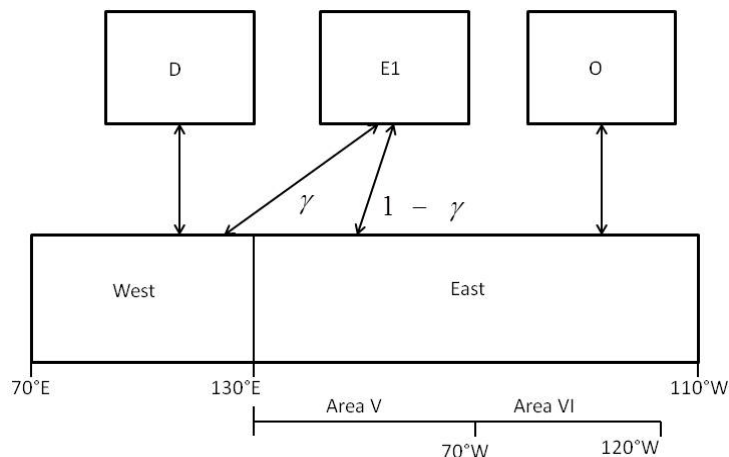

Fig. 1. Diagrammatic representation of the base case three-stock model. The traditional Area V and Area VI have been marked for reference.

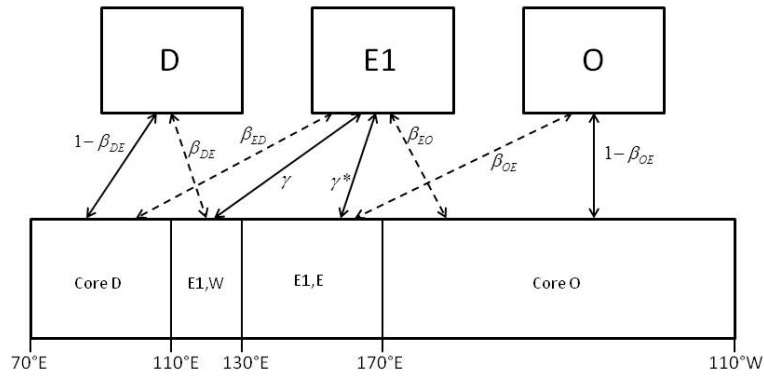

Fig. 2. Diagrammatic representation of the original three-stock model.

Fig. 3 illustrates the importance functions implemented, which serve to improve the sampling efficiency of the model. For the base case model, importance functions were utilised for r^D , r^{E1} , r^O and γ . For the original model, importance functions were only utilised for r^D and r^{E1} but not for r^O , since this parameter was not as well estimated for the original model as it was for the base case model.

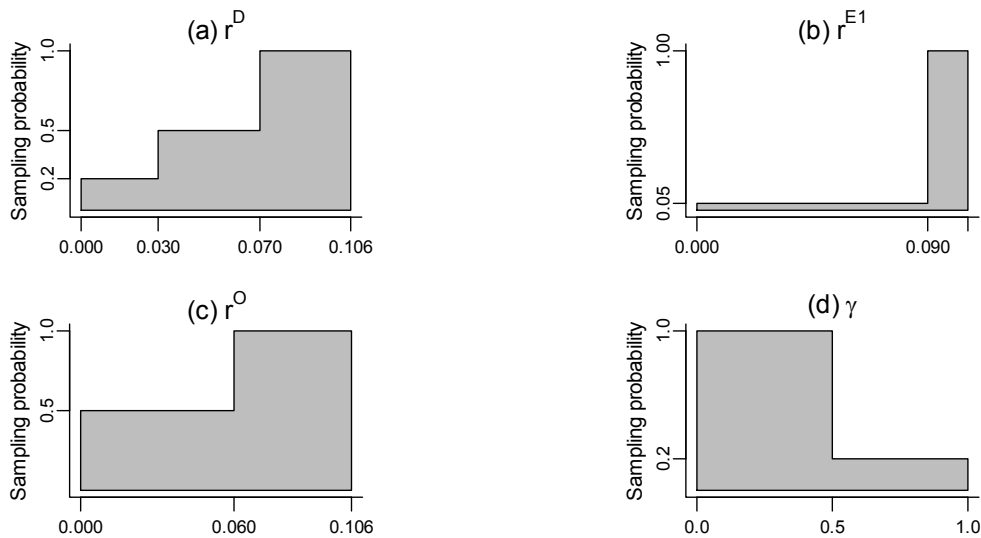

Fig. 3. Importance functions used when sampling the r^D , r^{E1} , r^O and γ parameters. The horizontal axis shows the step values at which the importance function increases, and the vertical axis shows the probability of accepting a sample from a particular range. Note that that the importance functions for r^D and r^{E1} were implemented for both the base case model and the original model. Importance functions for r^O and γ were implemented for the base case model only.

The sub-committee identified four sensitivity runs arising from the execution of multiple model runs, both intersessionally and at this meeting, namely:

- Sensitivity 1: Shifting of the Antarctic catch boundaries ((i)100% of catches between 60°E-100°W, (ii)100% of catches between 80°E-120°W and (iii) 50% catches from margin areas 60-80°E and 120-100°W). Diagrams of catch boundaries are given under Item 3.1.2.3.
- Sensitivity 2: Alternative bounds for the log of the BSD absolute abundance estimate ((i) U[ln18000,ln40000]), (ii) U[ln20000,ln40000] and (iii) U[ln15000,ln30000])
- Sensitivity 3: Allocate all New Zealand catches to BSO
- Sensitivity 4: Fit the model to the BSE1 Forestell *et al.* (2011) mark-recapture data instead of the Noad *et al.* (2011) relative abundance series.

RESULTS

Posterior median values for key model parameters are given in Table 1 for the base case model and for the specified sensitivity runs as have been provided for previous assessments.

Fig. 6 provides comparisons of the median population trajectories of the sensitivity runs with those for the base case model run.

Fig. 7 shows the BSD median population trajectories with fits to the relative abundances series (Bannister and Hedley (2001) and Hedley *et al.* (2011) for the model fit and Chittleborough (1965) as a consistency check) for the base case and the sensitivity runs. Similar plots have not been provided for BSE1 and BSO, as the results from the various runs were not qualitatively different.

Fig. 7 shows the posterior distributions for the estimated parameters for the base case model and each of the sensitivity runs.

COMPARISON WITH PREVIOUS BSD ASSESSMENT RESULTS

An assessment of BSD was completed in 2006 (IWC, 2007). At the time, the sub-committee agreed that the assessment modelling results should be considered preliminary and should be re-evaluated in the future. This reassessment would require clarification of stock structure of Oceania and the Pacific Island populations and the extent of mixing at high latitudes, as catch allocation would perhaps be influenced by mixing with BSE. The sub-committee noted at the time that the population had made a substantial increase since protection.

The three-stock models run in the 2014 assessment addresses the concerns expressed above as they allow for mixing of neighbouring breeding stocks in the Antarctic feeding areas. Direct comparisons between these results and those from 2006 should be viewed with caution as there were some differences in model inputs and assumptions. The inputs of the 2006 model were agreed on in the Hobart Workshop (SC/58/Rep5) and included a catch allocation of 80°E- 100°E (Core) and 50°E-130°E (Fringe); an absolute abundance estimate (the Paxton (2006) estimate); and population trend information (the reference case IWC (1996) series from five breeding ground surveys for the period 1982 to 1994, JARPA (Matsuoka *et al.* 2006), IDCR (Branch, 2006) and Chittleborough (1965) relative abundance series). During the Hobart Workshop, it was agreed that BSD is most closely connected to Area IV, but that there is potential mixing with Areas III and V (SC/58/Rep5, item 3.9, Stock D). On the basis of Discovery mark data, the catch allocation areas for BSD were defined as above. The bulk of the catches came from feeding areas and there were nearly twice as many in the Fringe as the Core area (SC/58/SH23).

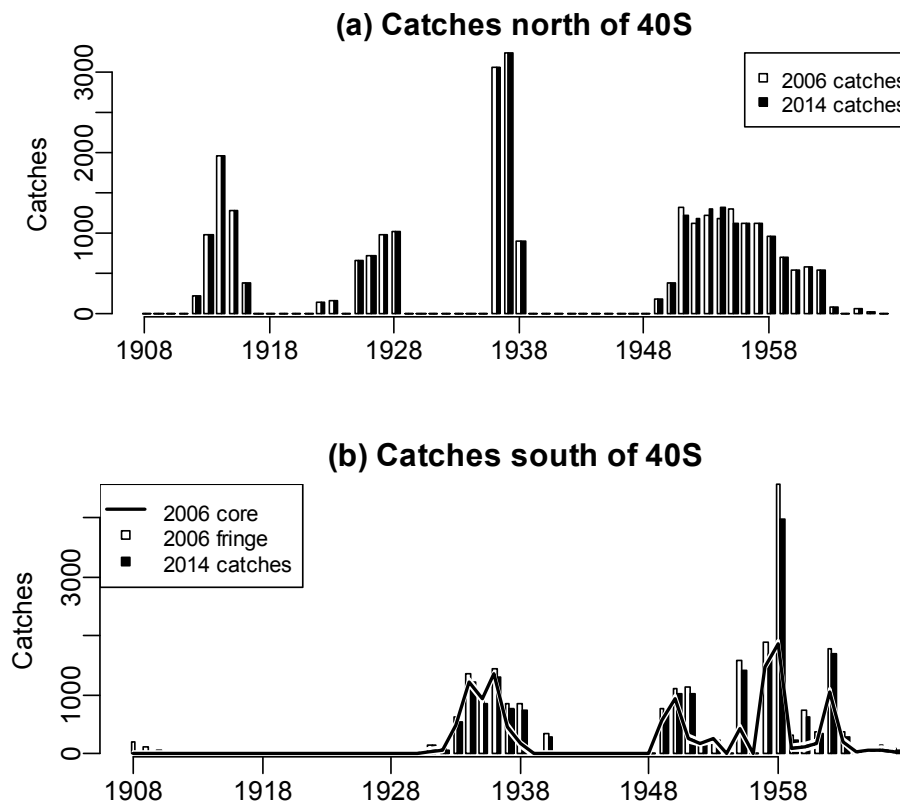

Fig. 4: Comparisons of the catches allocated to BSD in the 2006 assessment with those from the 2014 assessment. Note that the model allocates the historic feeding ground catches from 70°E-130°E to BSD and BSE1 in proportion to the relative model-predicted population sizes. The catches for the 2014 assessment in Figure (b) are therefore the median feeding ground catches that are allocated to BSD in the model.

Despite these differences in input assumptions the results of the 2006 Fringe model (Table 2 below, left) are similar to the current base case assessment results for BSD (Table 2 below, right).

Table 2: Selected BSD model parameter estimates for IWC (2007) (left) and for the 2014 assessment (right). Posterior medians with 5th and 95th percentiles (in brackets) are reported.

Selected BSD model parameter estimates. Posterior medians with the 5 th and 95 th percentiles (in brackets) are reported.			2014 base case assessment		
	Reference case: Fringe	Reference case: Core	<i>r</i>		
Catch history:					
<i>r</i> prior:	$r \sim U[0; 0.106]$	$r \sim U[0; 0.106]$	<i>r</i>	0.090	[0.053,0.104]
Recent abundance:	$N=10,032; CV=0.11$	$N=10,332; CV=0.11$	<i>K</i>	21686	[19016,29383]
Trend information:	IWC (1996)	IWC (1996)	<i>N_{min}</i>	824	[461,3685]
<i>r</i>	0.091 [0.046; 0.105]	0.090 [0.044; 0.105]	<i>N₂₀₀₆</i>	15986	[13785,21700]
<i>K</i>	22,690 [21,152; 29,892]	17,730 [16,380; 24,800]	<i>N_{min}/K</i>	0.039	[0.023,0.128]
<i>N_{min}</i>	721 [447; 2,189]	767 [470; 2,493]	<i>N₂₀₀₆/K</i>	0.735	[0.580,0.939]
<i>N₂₀₀₆</i>	15,729 [12,496; 17,828]	14,311 [12,227; 15,650]	<i>N₂₀₂₀/K</i>	0.984	[0.883,0.998]
<i>N_{min}/K</i>	0.032 [0.021; 0.073]	0.043 [0.028; 0.101]	<i>N₂₀₄₀/K</i>	1.000	[0.991,1.000]
<i>N₂₀₀₆/K</i>	0.689 [0.420; 0.812]	0.804 [0.503; 0.907]			
<i>N₂₀₂₀/K</i>	0.978 [0.686; 0.994]	0.990 [0.762; 0.998]			
<i>N₂₀₄₀/K</i>	1.000 [0.942; 1.000]	1.000 [0.961; 1.000]			

Table 1

Posterior median values of key model parameters are given with their 90% probability intervals for the base case model, the sensitivity runs as described in the text, and the original three-stock model.

		r		K		N_{min}		N_{min}/K		N_{2012}		N_{2012}/K			
BSD	Base case	0.090	[0.053,0.104]	21686	[19016,29383]			824	[461,3685]	0.039	[0.023,0.128]	19264	[17553,24012]	0.904	[0.739,0.984]
	Sen1(i): 60E-100W	0.092	[0.054,0.104]	21649	[19064,29150]			782	[460,3410]	0.038	[0.021,0.118]	19334	[17522,24241]	0.906	[0.748,0.986]
	Sen1(ii): 80E-120W	0.092	[0.053,0.103]	21204	[18858,28981]			823	[469,3446]	0.039	[0.022,0.126]	19056	[17291,24109]	0.914	[0.714,0.989]
	Sen1(iii): 50% margin	0.092	[0.053,0.104]	21269	[18947,29349]			793	[465,3598]	0.037	[0.022,0.127]	19196	[17408,24194]	0.91	[0.711,0.985]
	Sen2(i): U[18,40]	0.085	[0.035,0.100]	22571	[19507,37481]			1361	[663,9265]	0.060	[0.031,0.232]	21173	[19070,28005]	0.944	[0.729,0.993]
	Sen2(ii): U[20,40]	0.068	[0.034,0.097]	26156	[21639,39684]			2928	[960,13756]	0.109	[0.044,0.359]	23878	[21051,34852]	0.952	[0.692,0.999]
	Sen2(iii): U[15,30]	0.092	[0.053,0.104]	21587	[19328,28909]			771	[459,3353]	0.037	[0.022,0.114]	19389	[17438,23163]	0.902	[0.724,0.983]
	Sen3: NZ to BSO	0.090	[0.053,0.104]	21911	[18840,30511]			796	[429,4234]	0.035	[0.020,0.133]	19283	[17571,24363]	0.901	[0.750,0.981]
	Sen4: Forestell	0.088	[0.053,0.102]	21998	[19677,29655]			784	[455,3432]	0.036	[0.021,0.116]	19252	[17915,23680]	0.885	[0.789,0.980]
Original model	0.071	[0.032,0.099]	23658	[18381,40297]			1921	[579,12171]	0.065	[0.028,0.364]	19849	[17483,32648]	0.889	[0.652,0.998]	
BSE1	Base case	0.105	[0.103,0.106]	26133	[21605,29033]	0.068	[0.007,0.190]	237	[203,272]	0.009	[0.008,0.011]	16366	[14674,18034]	0.634	[0.561,0.729]
	Sen1(i): 60E-100W	0.105	[0.103,0.106]	26316	[21592,29208]	0.067	[0.006,0.201]	237	[203,273]	0.009	[0.008,0.011]	16292	[14593,18197]	0.631	[0.555,0.724]
	Sen1(ii): 80E-120W	0.105	[0.103,0.106]	26334	[21904,29002]	0.060	[0.005,0.178]	236	[202,272]	0.009	[0.008,0.011]	16283	[14751,18249]	0.633	[0.559,0.731]
	Sen1(iii): 50% margin	0.105	[0.103,0.106]	26227	[21712,29117]	0.063	[0.005,0.195]	235	[203,272]	0.009	[0.008,0.011]	16288	[14656,18139]	0.631	[0.558,0.727]
	Sen2(i): U[18,40]	0.105	[0.103,0.106]	26410	[21782,29045]	0.040	[0.004,0.169]	236	[203,272]	0.009	[0.008,0.011]	16246	[14657,18193]	0.621	[0.557,0.730]
	Sen2(ii): U[20,40]	0.105	[0.103,0.106]	26379	[21607,29065]	0.032	[0.004,0.167]	233	[203,273]	0.009	[0.008,0.011]	16043	[14777,17953]	0.614	[0.556,0.730]
	Sen2(iii): U[15,30]	0.105	[0.103,0.106]	26439	[21942,29140]	0.063	[0.005,0.195]	236	[204,273]	0.009	[0.008,0.011]	16369	[14822,18220]	0.631	[0.560,0.725]
	Sen3: NZ to BSO	0.106	[0.103,0.106]	23775	[20620,26241]	0.060	[0.002,0.169]	235	[208,277]	0.010	[0.008,0.013]	15954	[14425,17728]	0.676	[0.599,0.764]
	Sen4: Forestell	0.106	[0.104,0.106]	26450	[22813,28411]	0.036	[0.010,0.154]	210	[200,221]	0.008	[0.007,0.009]	15183	[14472,15845]	0.573	[0.538,0.647]
Original model	0.105	[0.102,0.106]	27658	[22916,30655]	-	-	238	[198,285]	0.009	[0.006,0.011]	16599	[14582,18505]	0.613	[0.476,0.722]	
BSO	Base case	0.091	[0.071,0.101]	14115	[10198,19651]			132	[103,250]	0.010	[0.007,0.014]	5072	[4456,6040]	0.371	[0.238,0.535]
	Sen1(i): 60E-100W	0.092	[0.072,0.101]	14089	[10090,20015]			130	[103,237]	0.010	[0.006,0.014]	5046	[4544,6013]	0.377	[0.238,0.535]
	Sen1(ii): 80E-120W	0.092	[0.070,0.100]	13930	[10006,18975]			131	[102,256]	0.011	[0.007,0.015]	5031	[4528,5876]	0.381	[0.245,0.535]
	Sen1(iii): 50% margin	0.092	[0.072,0.101]	14076	[9982,19721]			132	[102,239]	0.010	[0.007,0.014]	5047	[4564,5942]	0.377	[0.240,0.530]
	Sen2(i): U[18,40]	0.091	[0.070,0.100]	13099	[10098,19473]			134	[103,256]	0.011	[0.007,0.014]	5041	[4522,5809]	0.378	[0.239,0.537]
	Sen2(ii): U[20,40]	0.092	[0.070,0.101]	12989	[10095,19009]			135	[102,253]	0.011	[0.007,0.015]	5043	[4500,5900]	0.378	[0.243,0.538]
	Sen2(iii): U[15,30]	0.092	[0.072,0.101]	13944	[10084,19295]			133	[102,246]	0.010	[0.007,0.014]	5054	[4521,5882]	0.379	[0.244,0.533]
	Sen3: NZ to BSO	0.094	[0.074,0.101]	16418	[12925,20460]			121	[101,213]	0.008	[0.006,0.012]	5131	[4163,6117]	0.321	[0.237,0.436]
	Sen4: Forestell	0.093	[0.081,0.100]	12939	[10759,17727]			130	[103,183]	0.010	[0.007,0.011]	4945	[4787,5859]	0.379	[0.273,0.509]
Original model	0.071	[0.014,0.097]	15094	[10732,23973]			249	[113,1760]	0.021	[0.009,0.085]	4481	[2983,5578]	0.298	[0.130,0.505]	

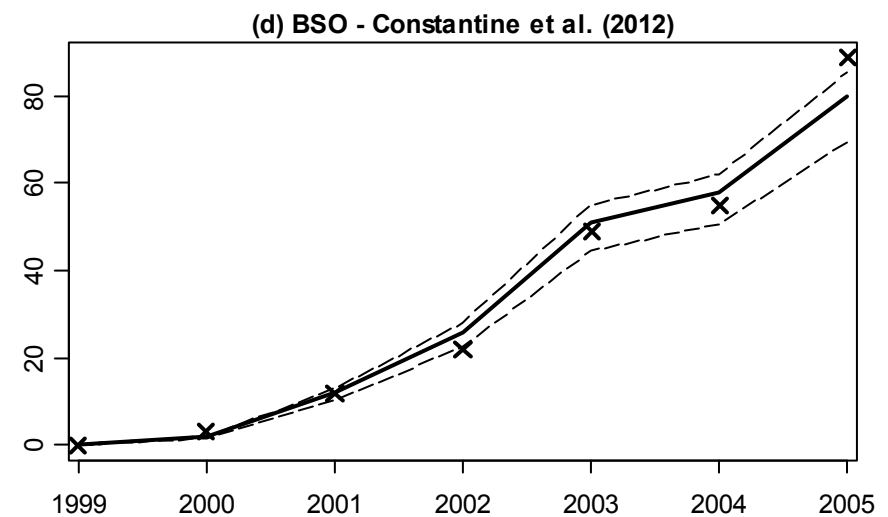
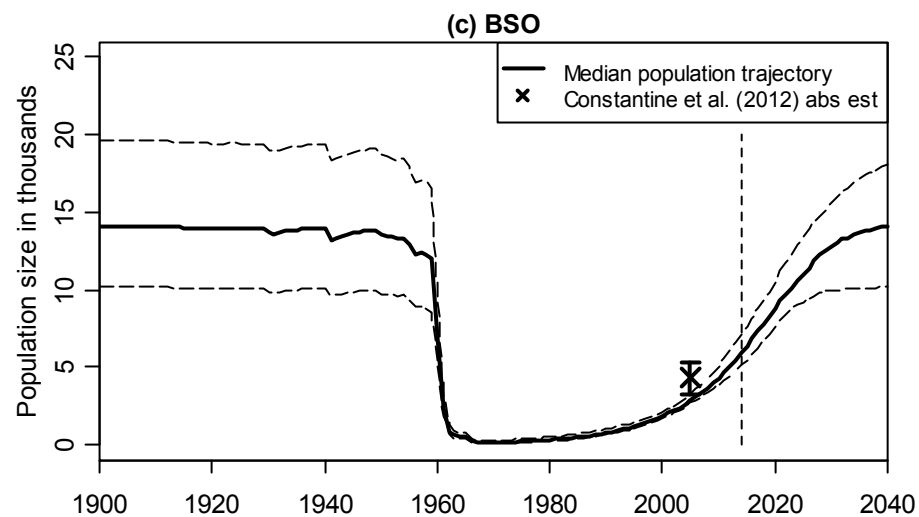
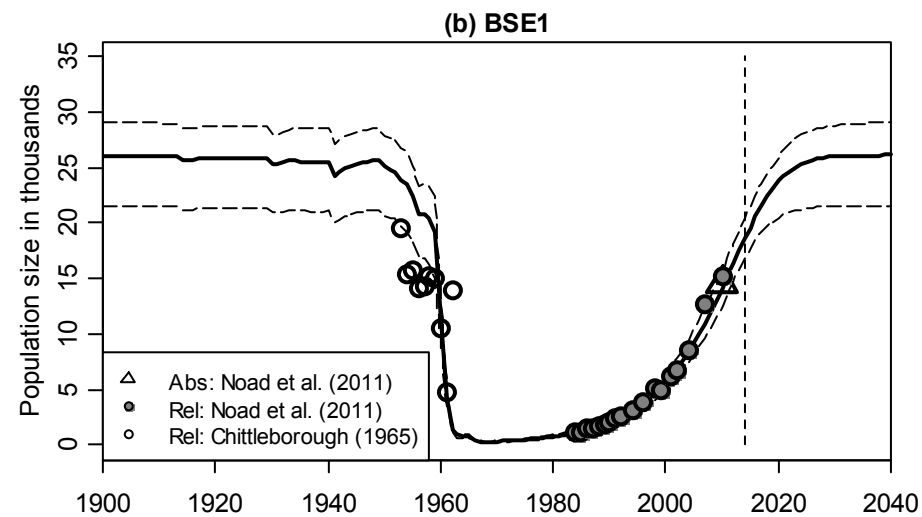
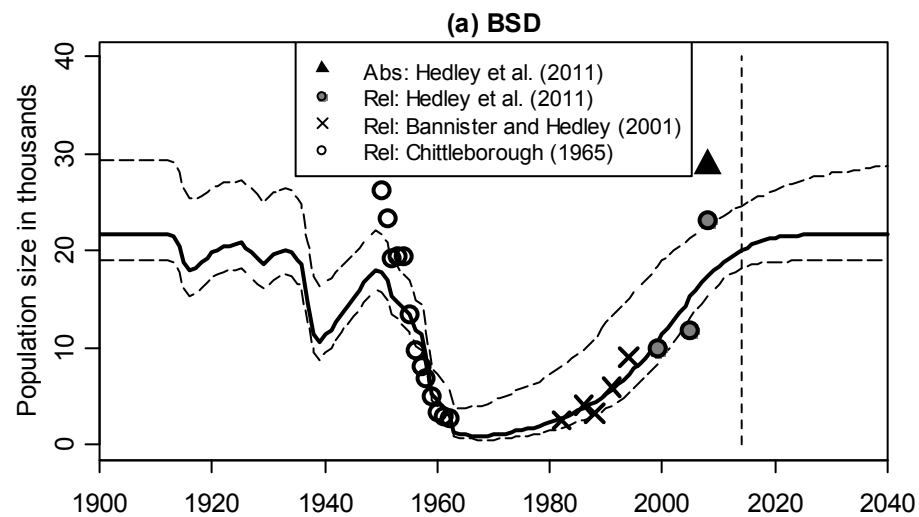

Fig. 5: Figures (a)-(c) show the median population trajectories for the base case three-stock model. 90% probability envelopes are indicated by the dashed lines. The model is fit to the Bannister and Hedley (2001) and the Hedley *et al.* (2011) relative abundance series for BSD (fits shown in Figure (a)); the Noad *et al.* (2011) absolute and relative abundance series for BSE1 (fits shown in Figure (b)), and to the Constantine *et al.* (2012) mark-recapture data for BSO (Figure (c)). In Figure (c), the cumulative observed re-sightings are marked by X's. Fits to the Hedley *et al.* (2011) absolute abundance estimate (Figure (a)); the Chittleborough (1965) relative abundance series (Figure (a) and (b)); and the Constantine *et al.* (2012) absolute abundance estimate (Figure (c)) are shown as consistency checks.

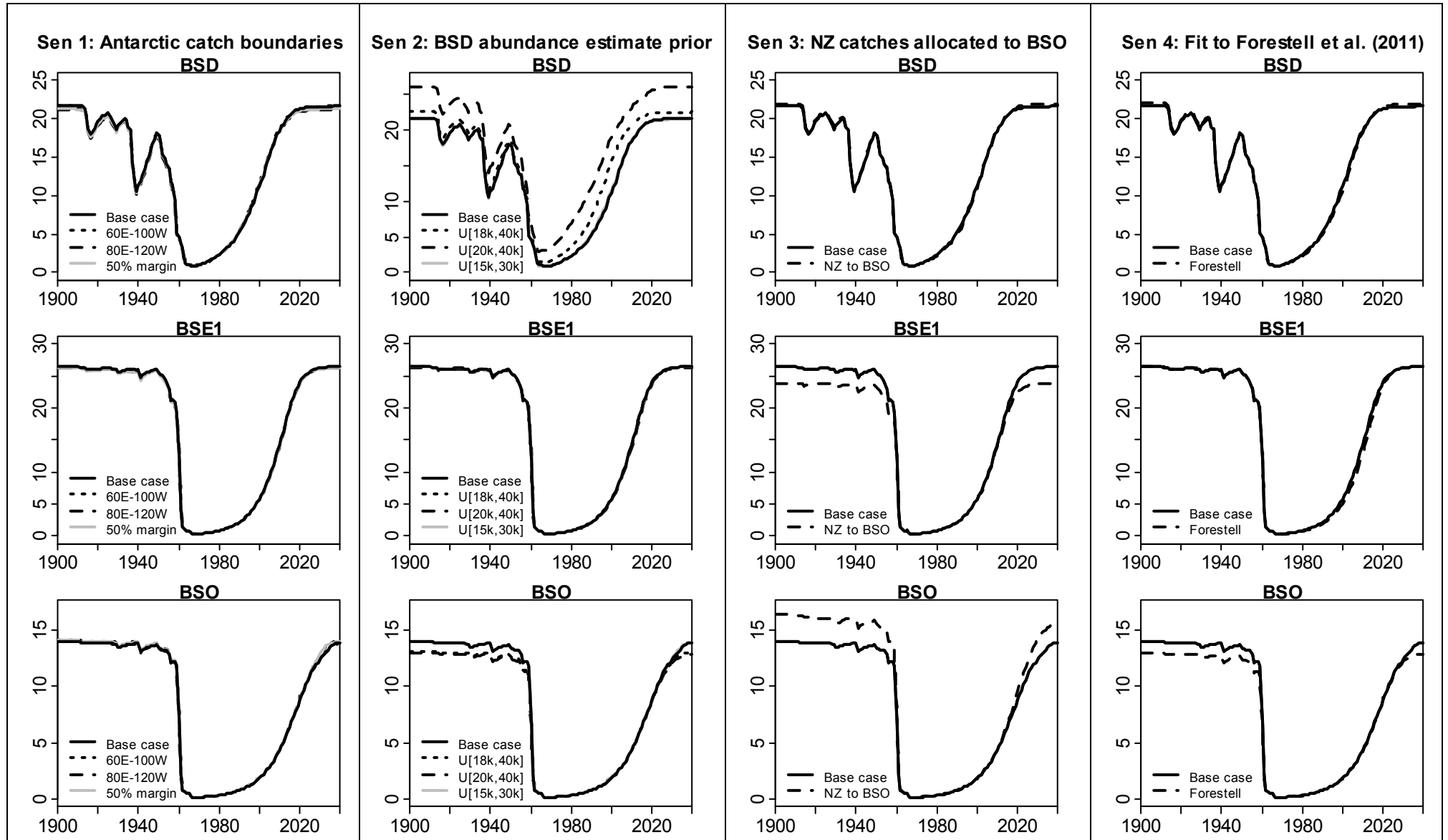

Fig. 6: Median population ‘trajectories’ for each of the four sensitivity runs (note that strictly these are not actual trajectories, but juxtaposition of successive values form posterior probability distributions for each year). For each plot, the solid line corresponds to the base case run.

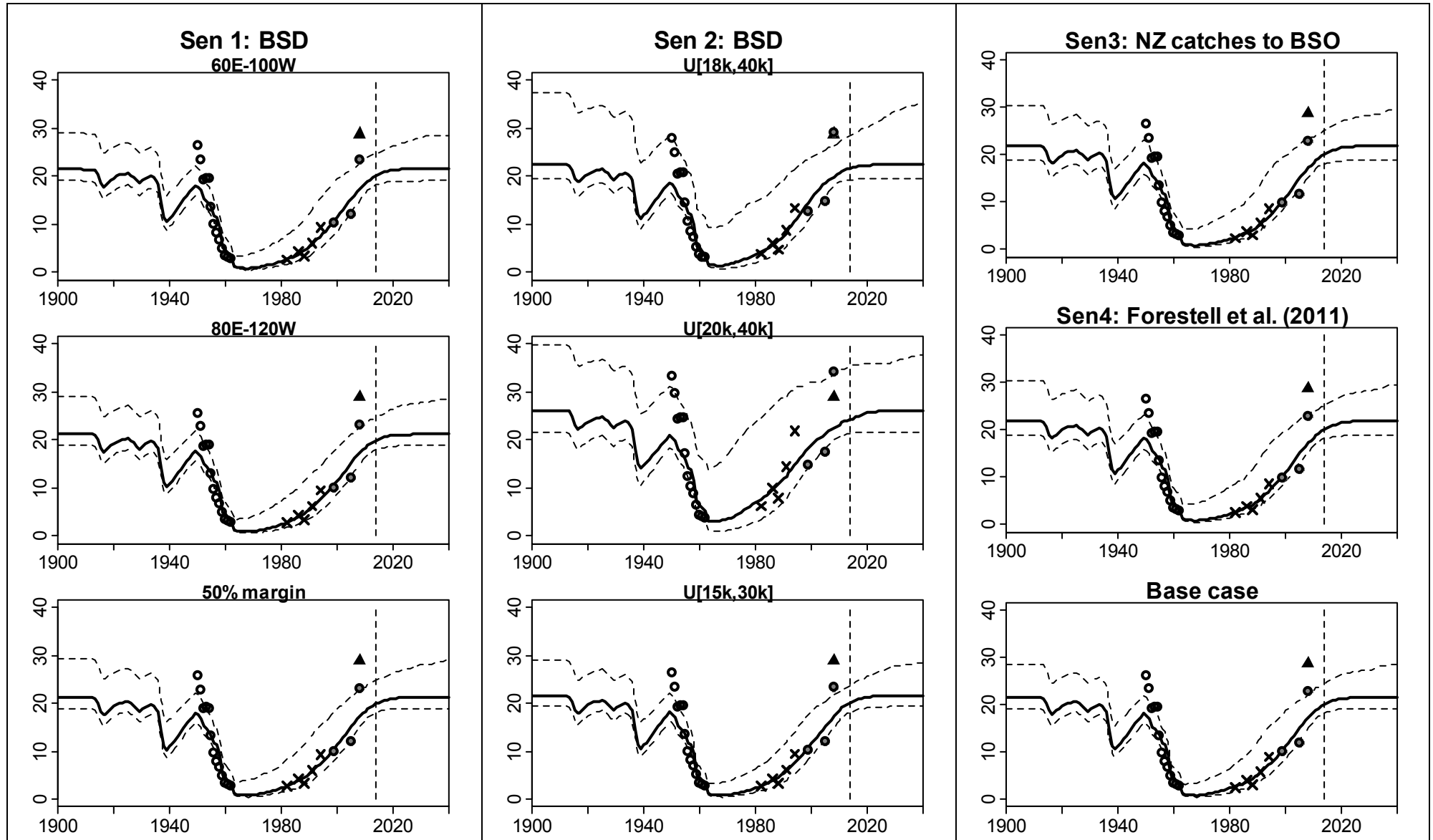

Fig. 7: BSD median population trajectories, 90% probability envelopes (indicated by dashed lines), and fits to the relative abundance series for the three sensitivity runs. Plots show fits to the Chittleborough (1965) relative abundance series (open circles), the Bannister and Hedley (2001) relative abundance series (crosses), the Hedley *et al.* (2011) relative abundance series (grey circles) as well as the Hedley *et al.* (2011) absolute abundance estimate (black triangle). In all cases the model was fit to the Hedley *et al.* (2011) and the Bannister & Hedley (2001) relative abundance series. The Chittleborough (1965) relative abundance series and Hedley *et al.* (2011) absolute abundance estimate are shown as consistency checks.

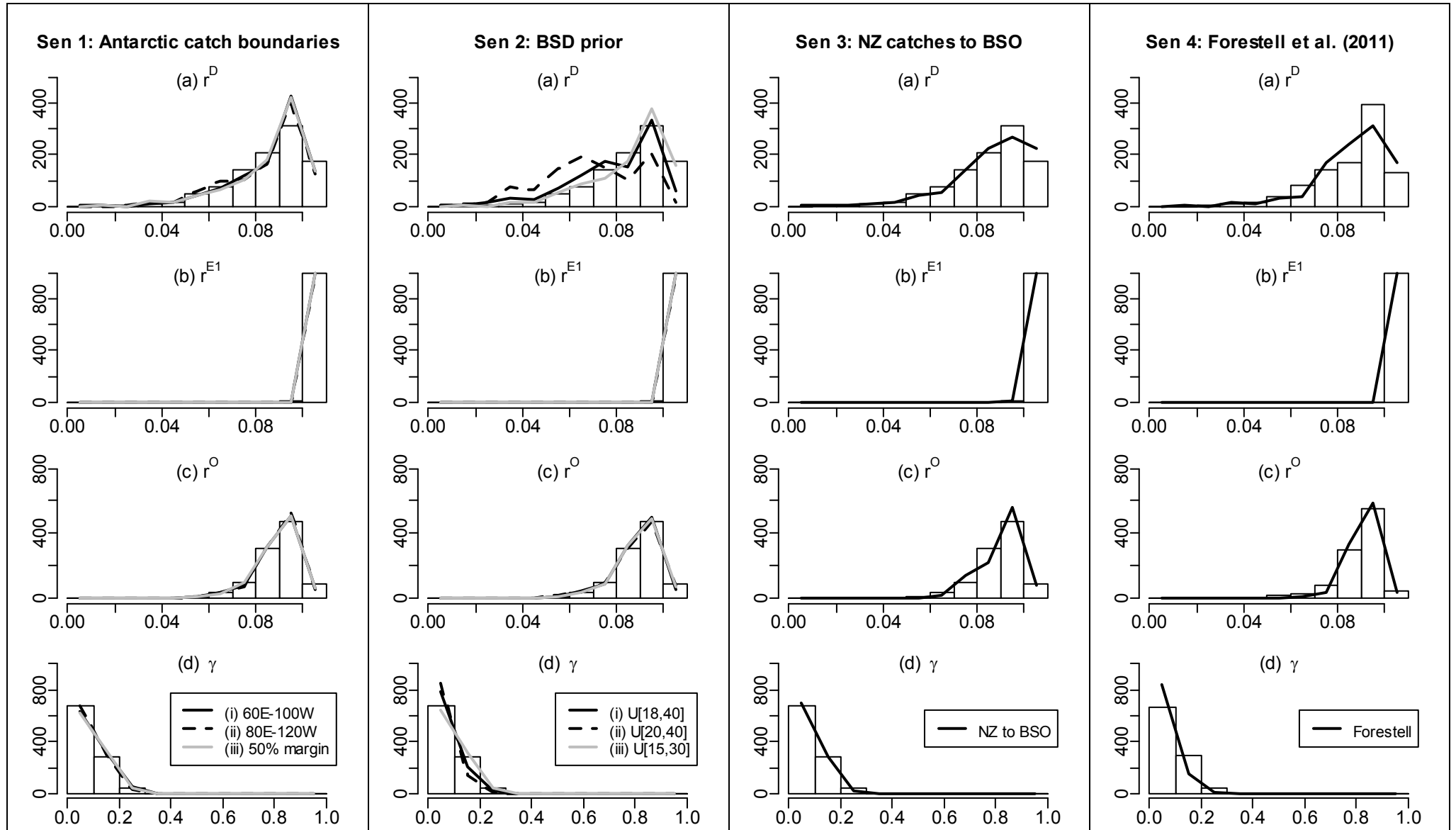

Fig. 8: Posterior distributions. The white bars give the posterior distributions for the base case, and the lines for the sensitivity runs as described in the figure legends. In all cases the prior distributions were uniform, but note truncation effects for the final bar in the r plots as that bar spans $[0.10, 0.11]$, but the prior extends only to $r=0.106$.

